

Etulevyt

kahvoille tyyppi I, II, IV, IVs tai VII Pääluettelo 33, sivu 241, 242

Etulevyt

3 U

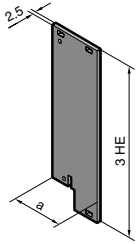

6 U

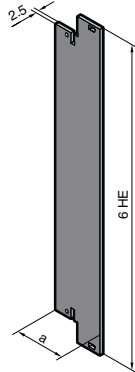

3 U

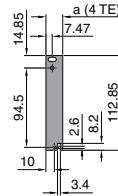
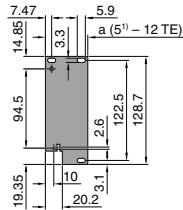

6 U

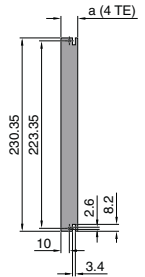
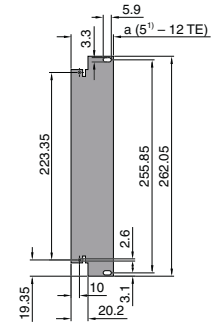

1) 5,9 x 3,3 mm pitkää reikää ei ole rakenteissa 5 – 7 TE.

U-muotoiset etulevyt

3 U

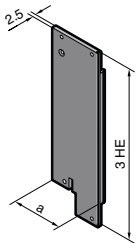

6 U

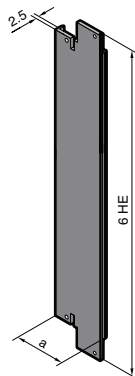

3 U

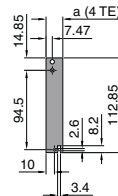
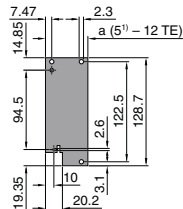

6 U

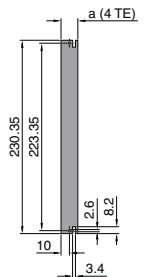
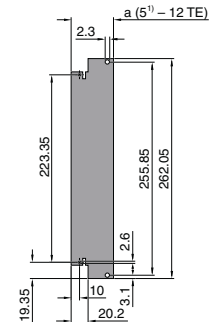

1) 2,3 mm reikää ei ole rakenteissa 5 – 7 TE.

Taulukko suorille ja U-muotoisille etulevyille:

TE	4	5	6	7	8	10	12
a (mm)	20,0	25,1	30,1	35,2	40,3	50,5	60,6

Vipukahva

Etulevyasennukseen ylös ja alas Pääluettelo 33, sivu 241

Tyyppi I

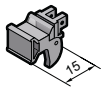

Tyyppi II

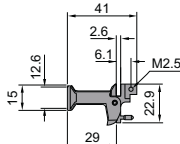
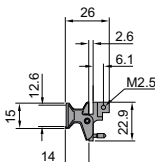
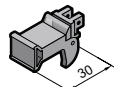

KytKentäkaapit

Yleiskehikkojen lisävarusteet

Työntö-/vetokahva

Pääluettelo 33, sivu 241

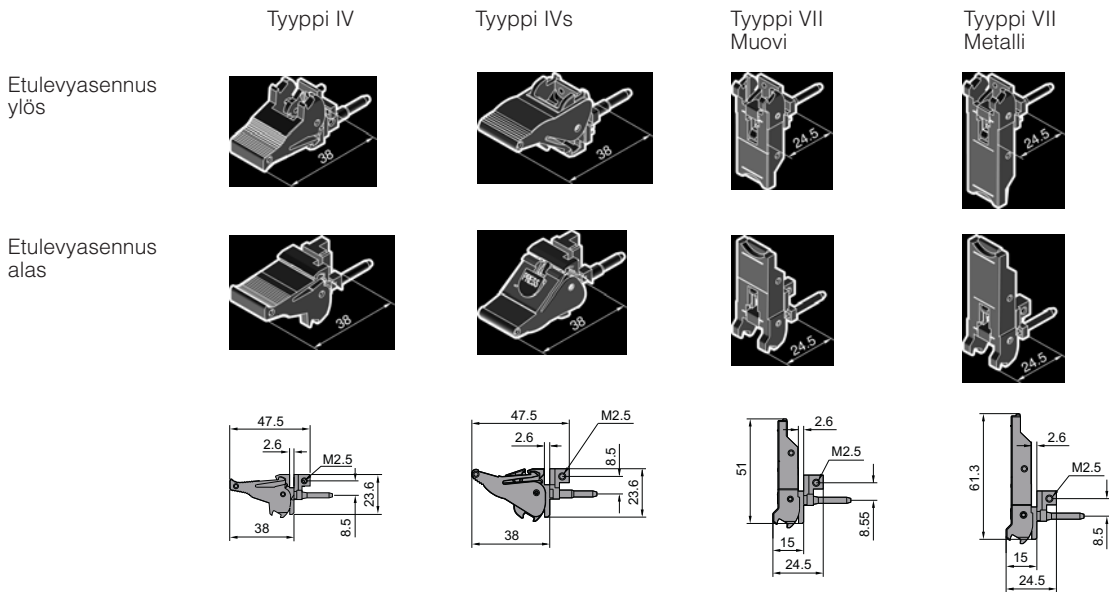

Mikrokytkin

kaapeliilla ja pistokkeella Pääluettelo 33, sivu 242

- 1** Vipua ei painettu
- 2** Vivun nivel
- 3** Vivun kosketuskohta

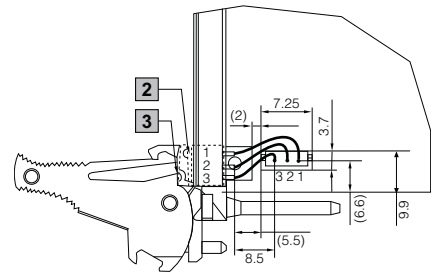
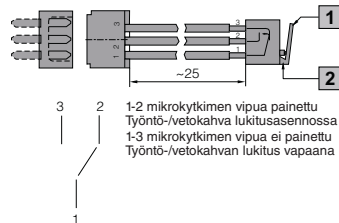

Etulevyt

kahvoille tyyppi V ja VI Pääluettelo 33, sivu 243, 244

Etulevyt

3 U

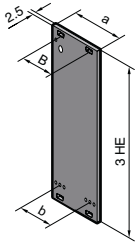

6 U

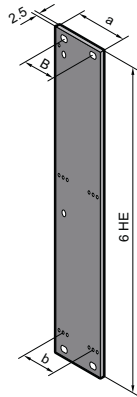

3 U

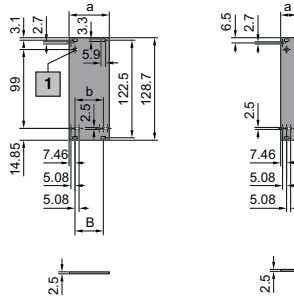

6 U

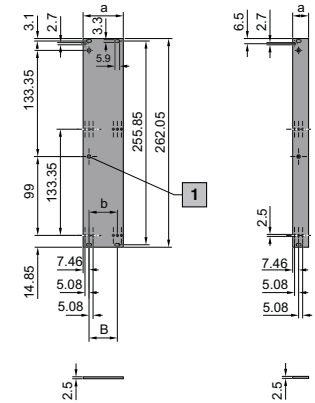

U-muotoiset etulevyt

6 U

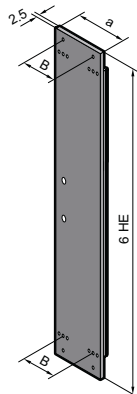

1 Uputus ruuville M2,5 (2x)

6 U

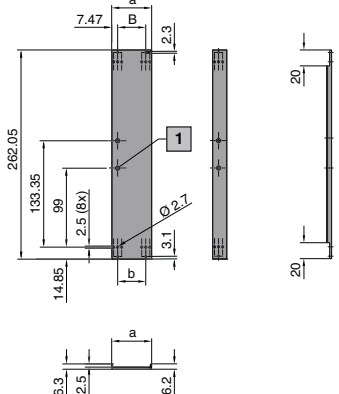

HE = U

Taulukko suorille etulevyille:

TE	4	5	6	7	8	10	12	14
a (mm)	20,0	25,1	30,1	35,2	40,3	50,5	60,6	70,8
B (mm)	-	-	-	-	-	35,6	45,7	55,9
b (mm)	-	-	15,2	20,3	25,4	35,6	45,7	55,9

Taulukko U-muotoisille etulevyille:

TE	4	8	10
a (mm)	20,0	40,3	50,5
B (mm)	-	25,4	35,6
b (mm)	-	25,4	35,6

Käsikahvat

Pääluettelo 33, sivu 243

Tyyppi V
Muovi

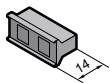

Tyyppi V
Alumiini

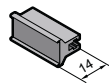

Tyyppi VI
Alumiini

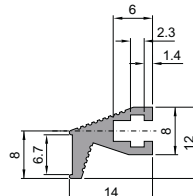
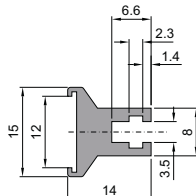
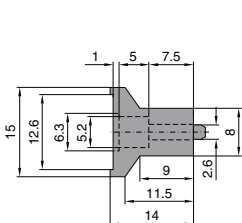
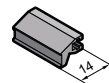

KytKentäkaapit

Yleiskehikkojen lisävarusteet

Etulevyjen asennus

Suorat etulevyt 3 U, ei-EMC, kahvoille tyyppi I, II, IV, IVs, VII Pääluettelo 33, sivu 241, 242

8 TE – 12 TE

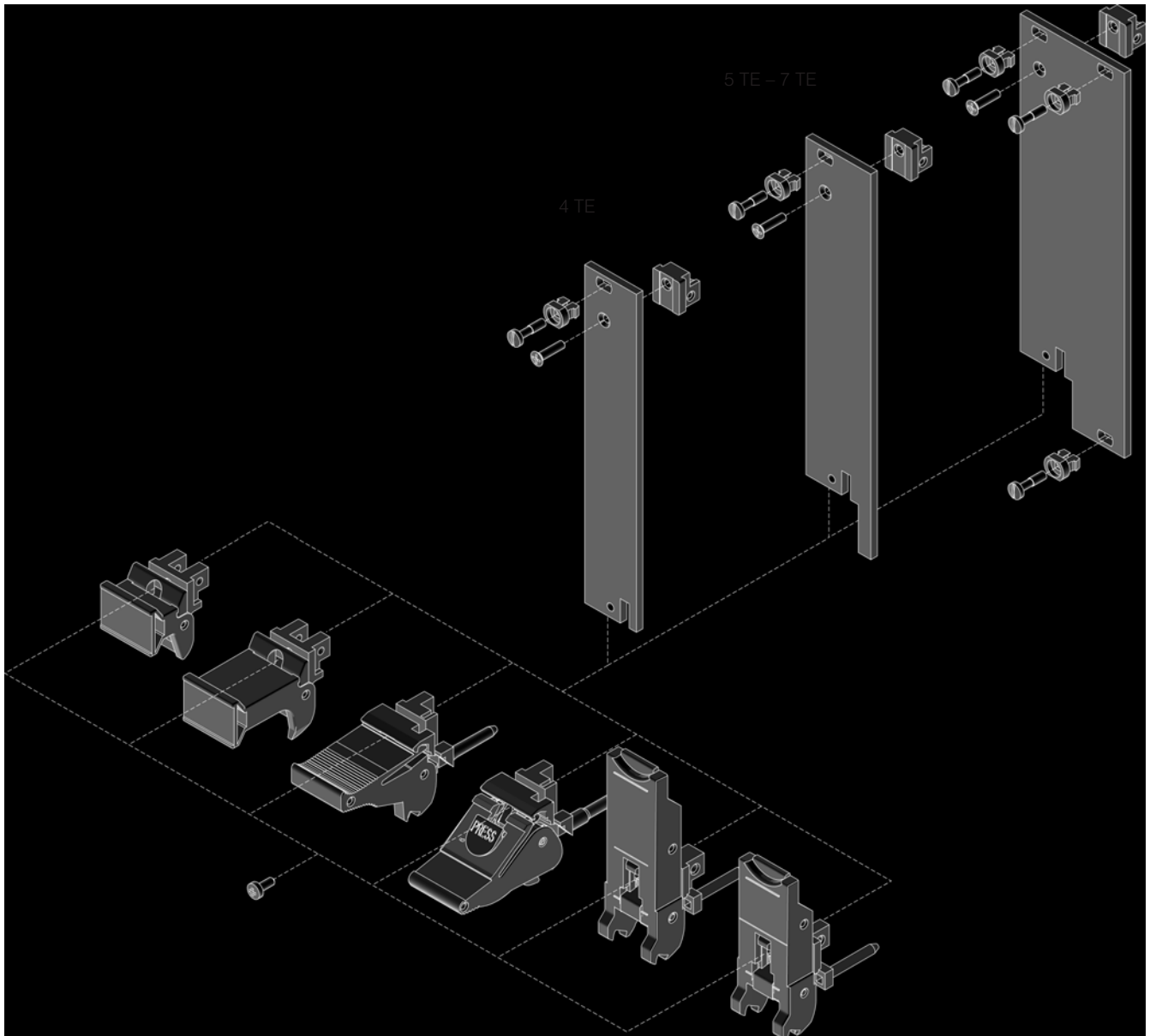

Etulevyjen asennus

Suorat etulevyt 6 U, ei-EMC, kahvoille tyyppi I, II, IV, IVs, VII Pääluettelo 33, sivu 241, 242

8 TE – 12 TE

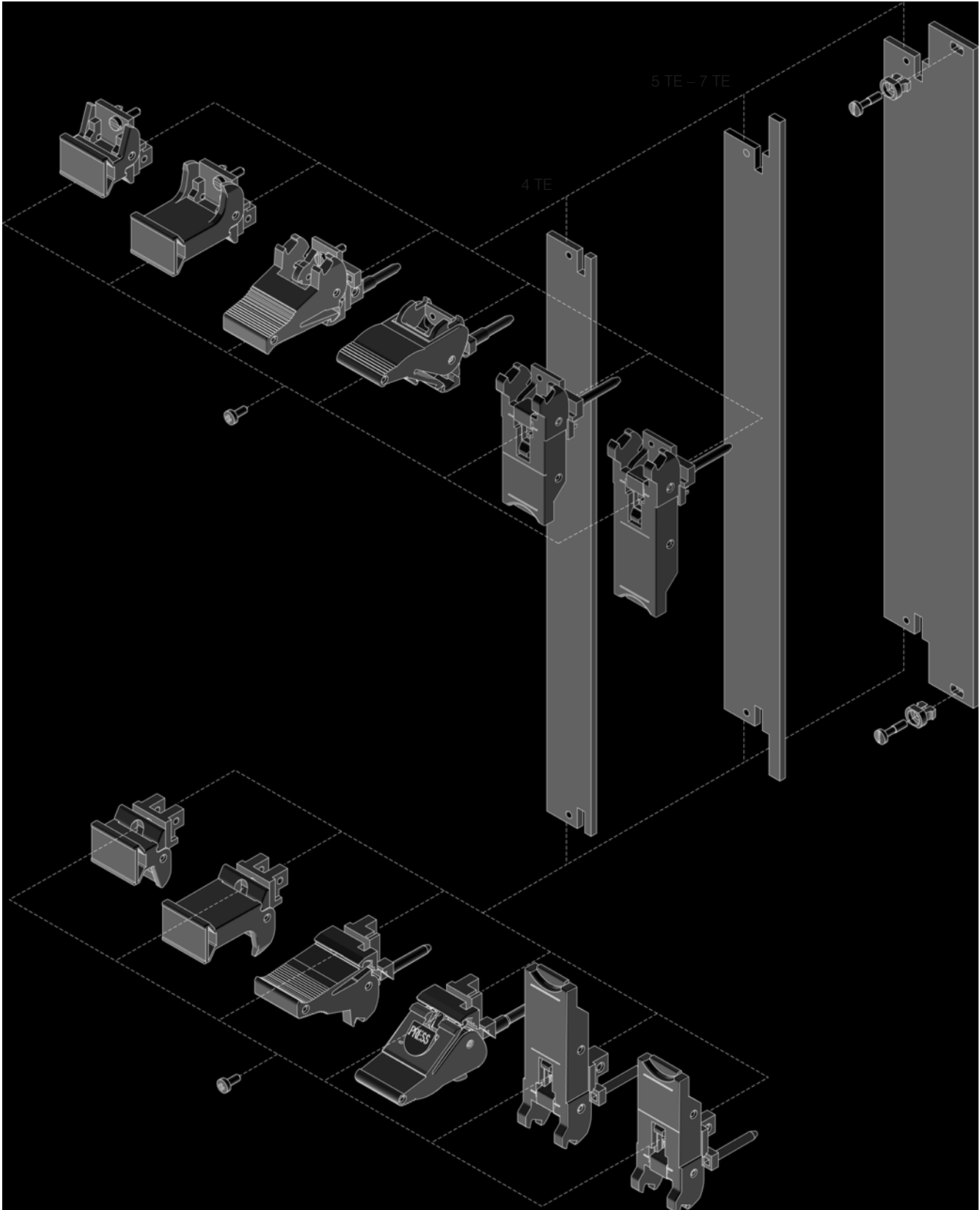

KytKentäkaapit

Yleiskehikkojen lisävarusteet

Etulevyjen asennus

U-muotoiset etulevyt 3 U, EMC, kahvoille tyyppi I, II, IV, IVs, VII Pääluettelo 33, sivu 241, 242

8 TE – 12 TE

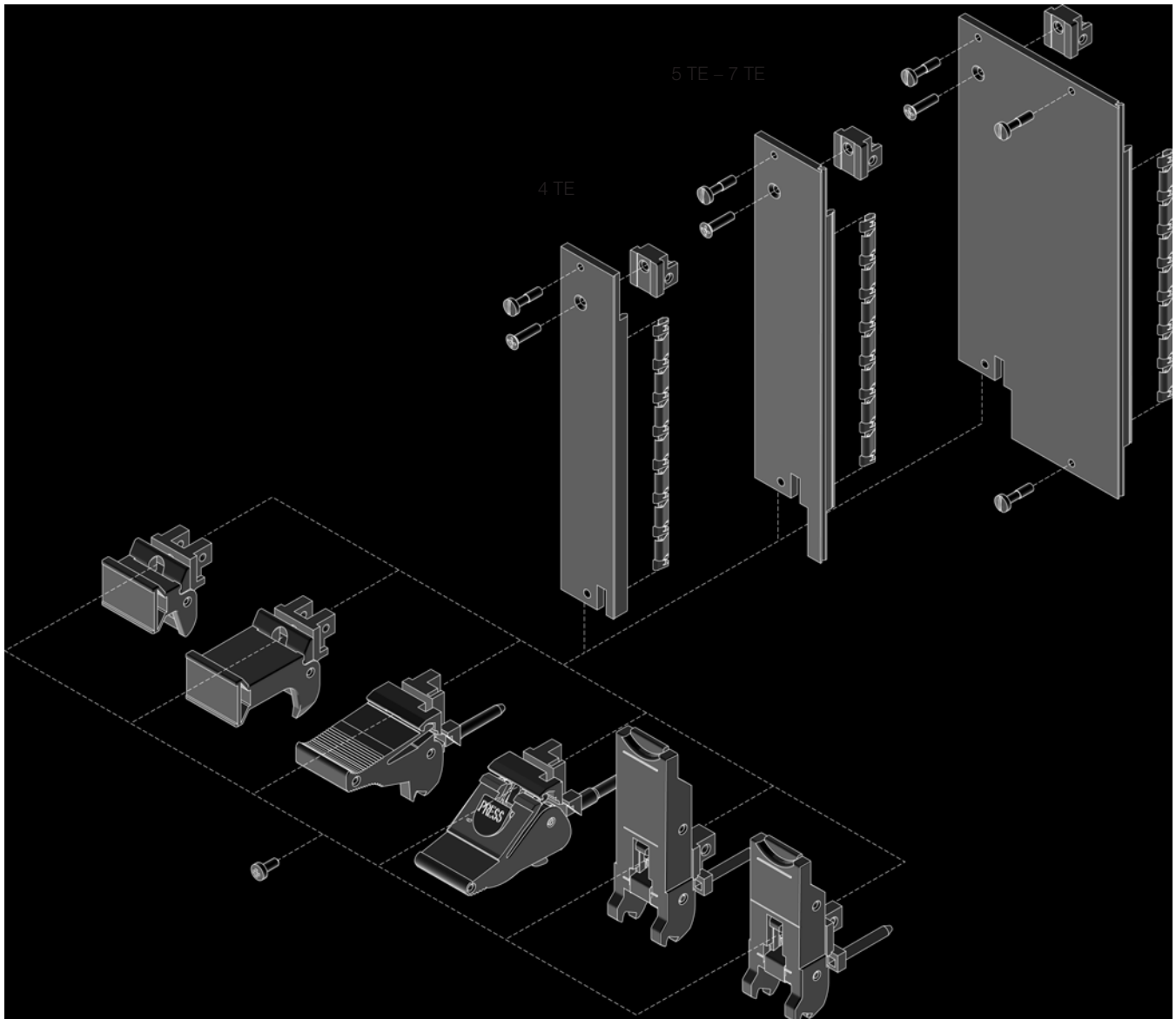

Etulevyjen asennus

U-muotoiset etulevyt 6 U, EMC, kahvoille tyyppi I, II, IV, IVs, VII Pääluettelo 33, sivu 241, 242

8 TE – 12 TE

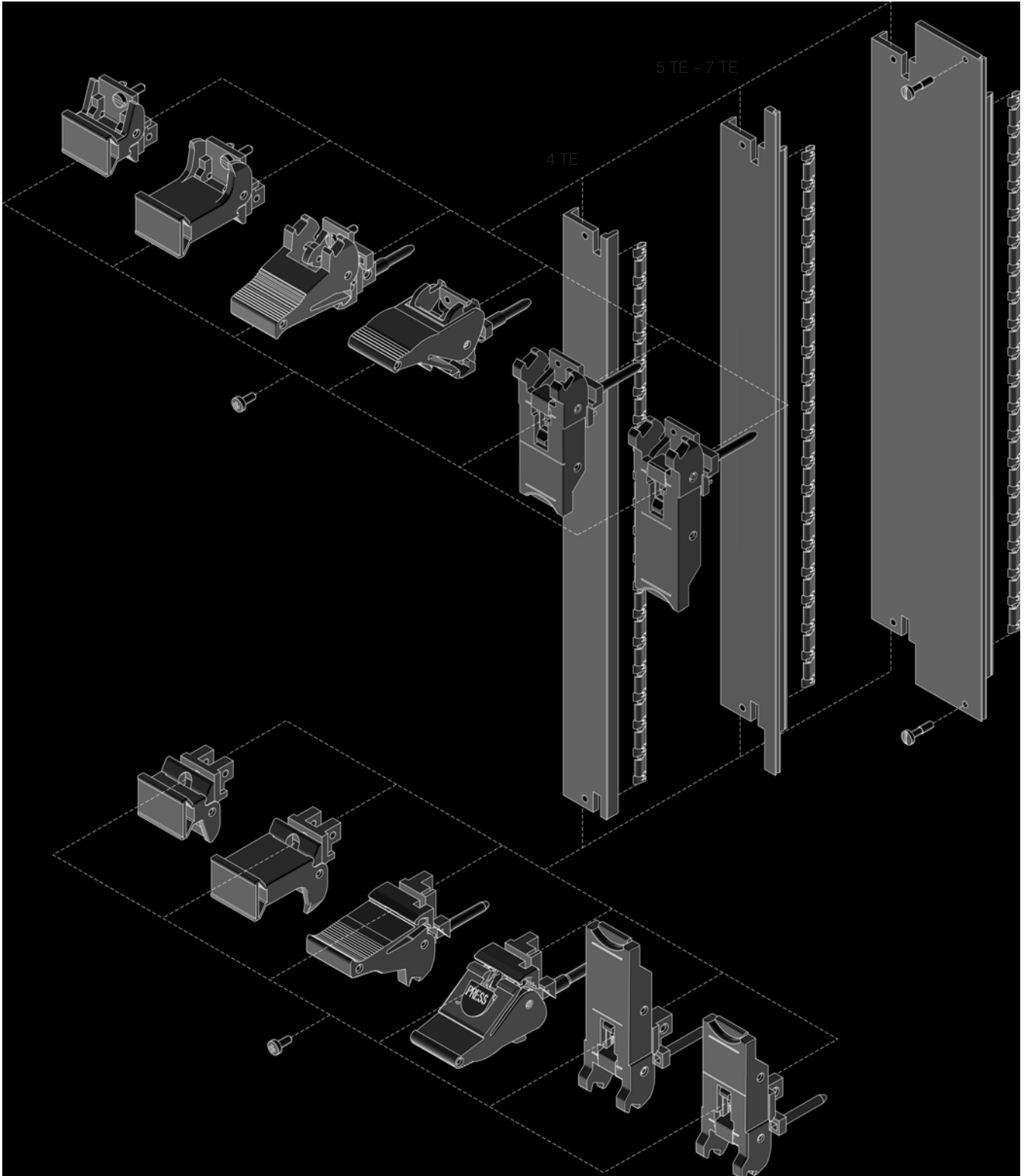

KytKentäkaapit

Yleiskehikkojen lisävarusteet

Etulevyjen asennus

Suorat etulevyt 3 U/6 U, ei-EMC, kahvoille tyyppi V, muovi Pääluettelo 33, sivu 243, 244

3 U, 4 TE

3 U, 6 TE – 8 TE

3 U, 10 TE – 14 TE

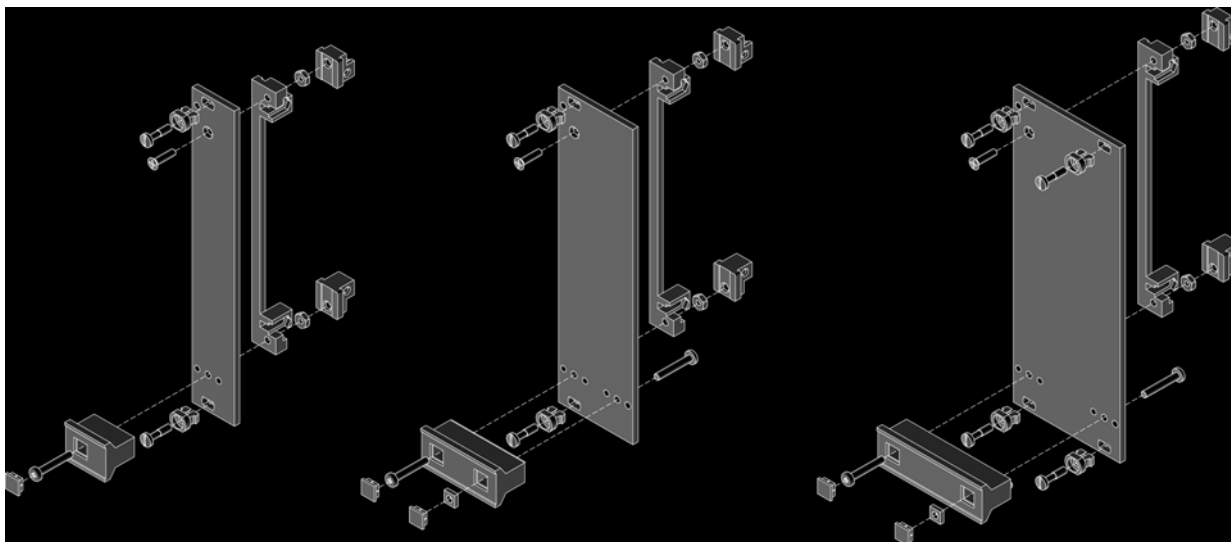

6 U, 4 TE

6 U, 6 TE – 8 TE

6 U, 10 TE – 14 TE

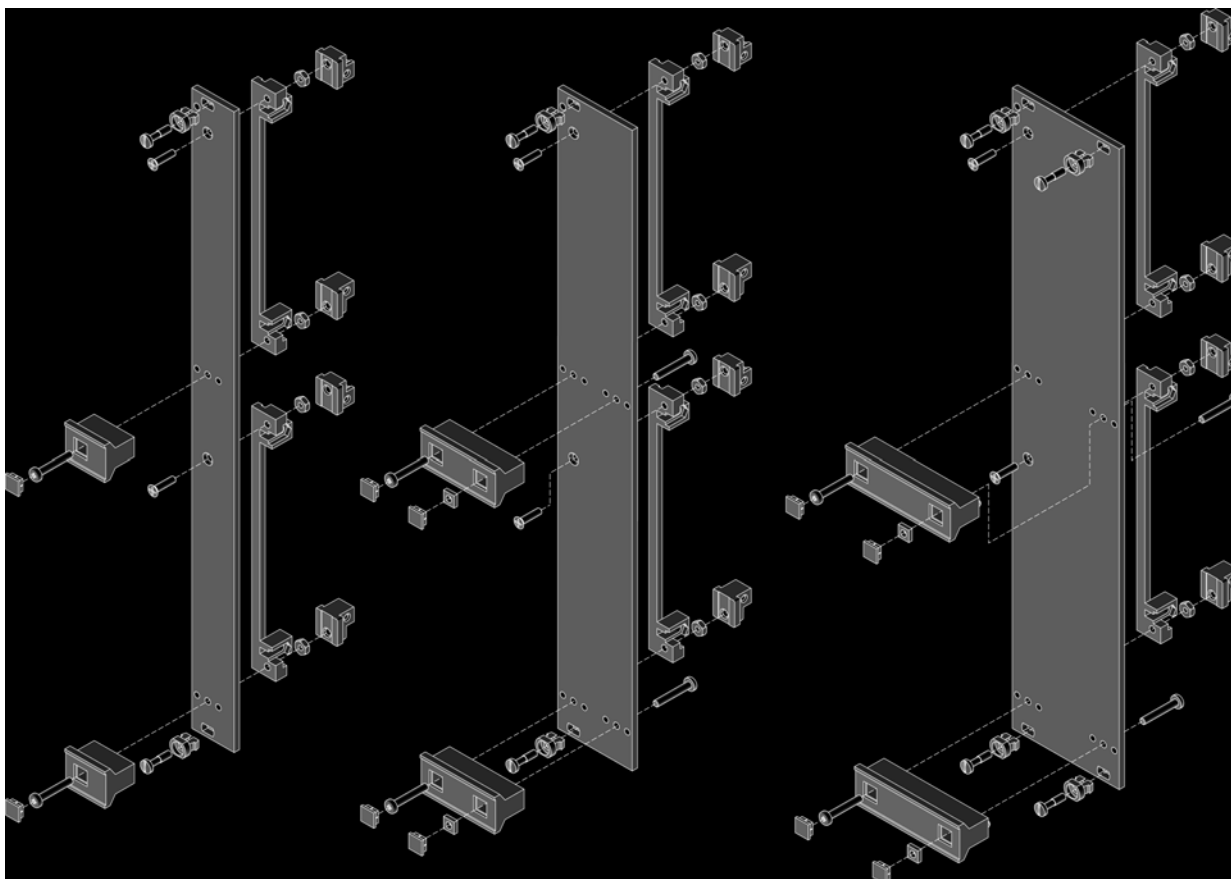

Etulevyjen asennus

U-muotoiset etulevyt 6 U, EMC, kahvoille tyyppi V, muovi Pääluettelo 33, sivu 243, 244

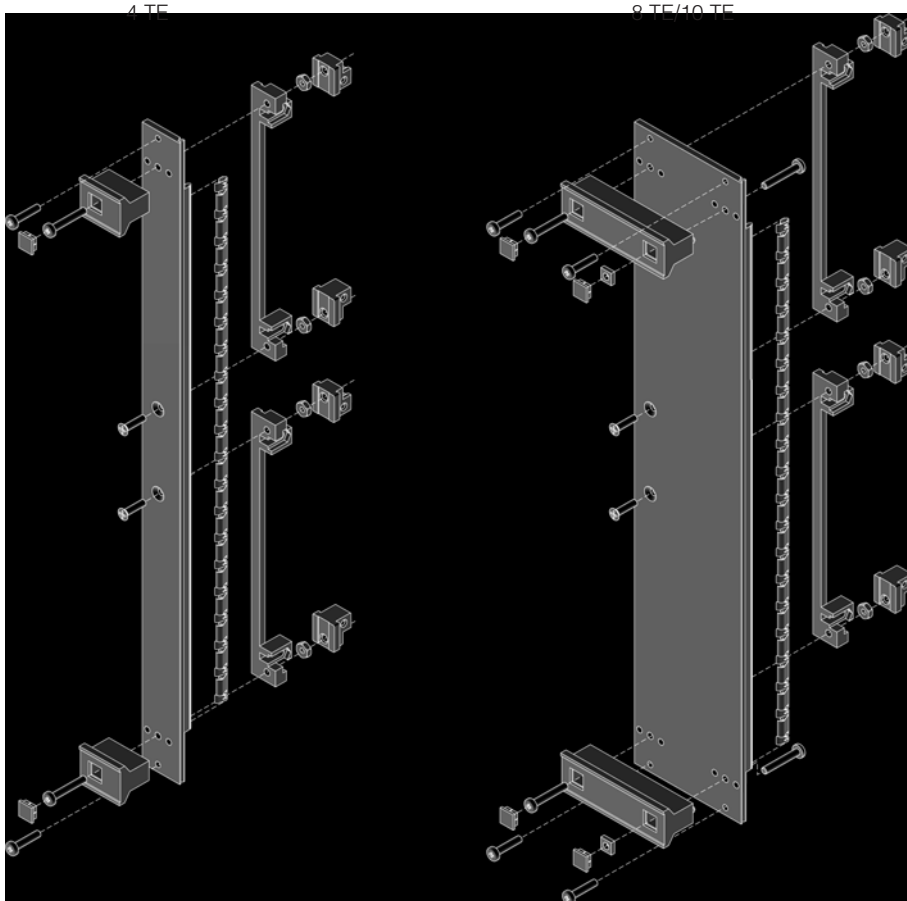

Kytöntäkaapit

Yleiskehikkojen lisävarusteet

Etulevyjen asennus

U-muotoiset etulevyt 6 U, EMC, kahvoille tyyppi V, VI, alumiini Pääluettelo 33, sivu 243, 244

4 TE

8 TE/10 TE

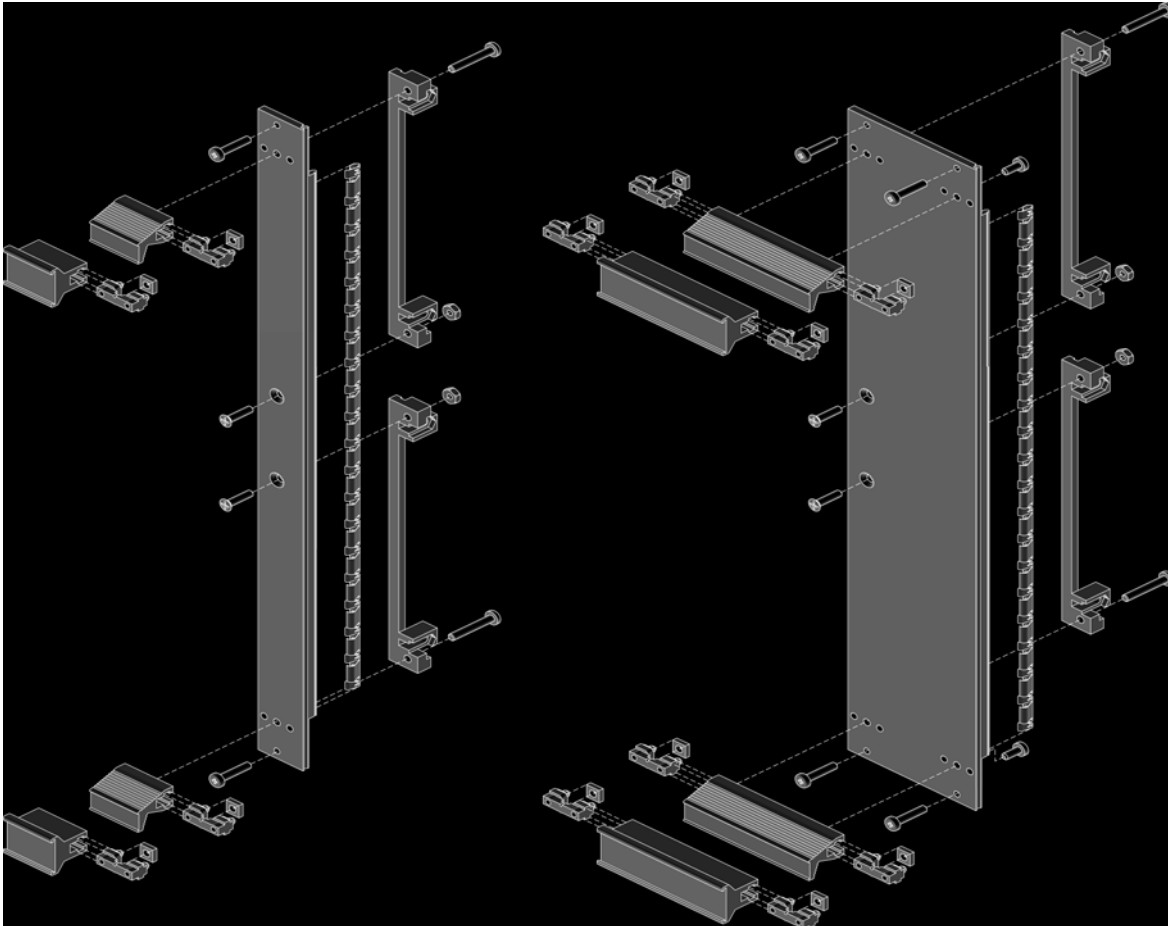

Korttipidin

etulevyille Päälueetelo 33, sivu 245

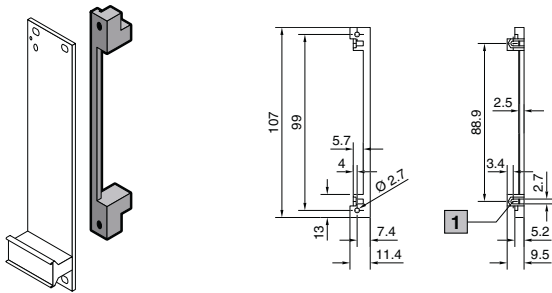

1 Mutterille M2,5

Etulevyt

tyhjien paikkojen täyttämiseen Päälueetelo 33, sivu 239

Suora

2 TE – 85 TE

U-muotoinen

2 TE – 14 TE

20 TE – 84 TE

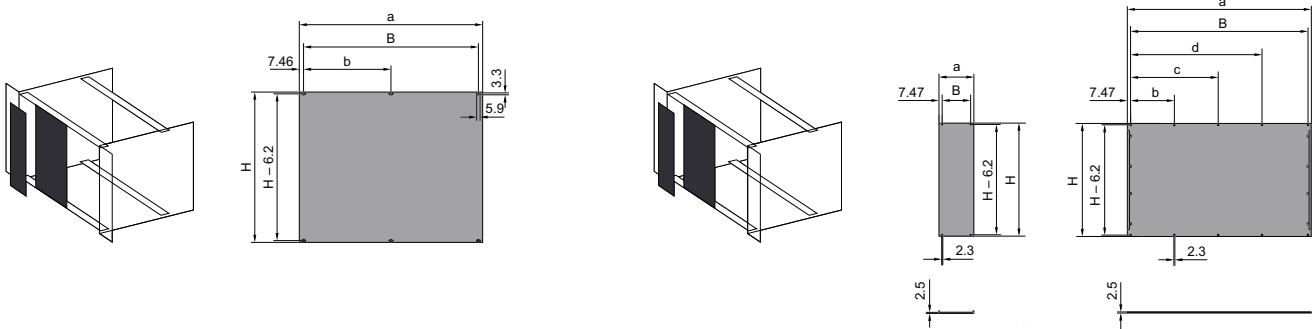

H = Korkeus

Etulevy tyhjien paikkojen täyttämiseen, suora

1 U H = 39,8 mm	3 U H = 128,7 mm	4 U H = 173,15 mm	6 U H = 262,05 mm	7 U H = 306,5 mm			
TE	TE	TE	TE	TE	a	B	b
-	2	-	2	-	9,8	-	-
-	3	-	3	-	14,9	-	-
-	4	-	4	-	20,0	-	-
-	5	-	5	-	25,1	-	-
-	6	-	-	-	30,1	-	-
-	7	-	-	-	35,2	-	-
-	8	-	8	-	40,3	-	-
-	10	-	10	-	50,5	35,6	-
-	12	-	12	-	60,6	45,7	-
-	14	-	14	-	70,8	55,9	-
-	20	-	-	-	101,3	86,4	-
-	21	-	-	-	106,4	91,4	-
-	28	-	28	-	141,9	127,0	-
-	40	-	40	-	202,9	188,0	-
-	42	42	42	-	213,0	198,1	-
84	84	84	84	84	426,4	411,5	203,2
-	85	-	85	-	431,5	431,5	203,2

Etulevy tyhjien paikkojen täyttämiseen, U-muotoinen

1 U H = 39,8 mm	3 U H = 128,7 mm	6 U H = 262,05 mm					
TE	TE	TE	a	B	b	c	d
-	2	2	9,8	-	-	-	-
-	3	-	14,9	-	-	-	-
-	4	4	20,0	-	-	-	-
-	5	5	25,1	-	-	-	-
-	6	6	30,1	-	-	-	-
-	7	-	35,2	-	-	-	-
-	8	8	40,3	25,4	-	-	-
-	10	10	50,5	35,6	-	-	-
-	12	12	60,6	45,7	-	-	-
-	14	14	70,8	55,9	-	-	-
-	20	20	101,3	86,4	-	-	-
-	21	-	106,4	91,4	-	-	-
-	28	28	141,9	127,0	61,0	-	-
-	40	-	202,9	188,0	91,5	-	-
-	42	42	213,0	198,1	96,5	-	-
-	60	60	304,5	289,6	96,5	193,0	-
84	84	84	426,4	411,5	101,6	203,2	304,8

Kytentäkaapit

Yleiskehikkojen lisävarusteet

Etulevyt/EMC-etulevyt

saranoitu Pääluettelo 33, sivu 239

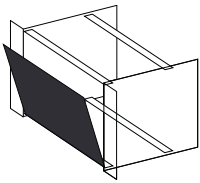

Etu-/takalevyt ilmanvaihtoa varten

Pääluettelo 33, sivu 239

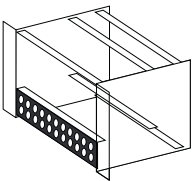

HE = U

EMC-rakenne

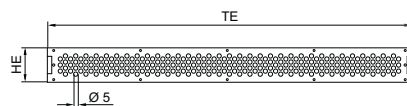

Ei-EMC-rakenne

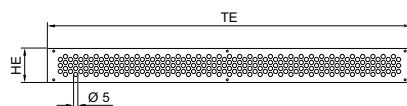

EMC-rakenne:

U	TE	Til.nro RP
1	84	3688.029
3	84	3688.030

Ei-EMC-rakenne:

U	TE	Til.nro RP
1	84	3684.812
3	84	3684.814

Ripac-kasetit – tyyppi I

Pääluettelo 33, sivu 246

Leikkaus A – A
Tyyppi I, 3 U

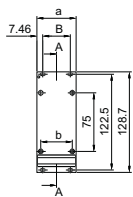

Leikkaus B – B
Tyyppi I, 3 U

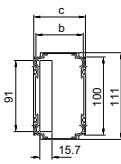
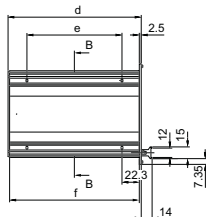

Kortin syvyys 160 mm

Til.nro RP	TE	Mitat (mm)						
		a	B	b	c	d	e	f
3 U								
3653.000	6	32,2	–	20,3	27,5	171,5	122	167
3653.010	8	40,3	–	30,5	36,0	171,5	122	167
3653.020	10	50,5	35,6	40,6	46,2	171,5	122	167
3653.030	12	60,6	45,7	50,8	56,4	171,5	122	167
3653.040	14	70,8	55,9	60,9	66,5	171,5	122	167
3653.050	21	106,3	91,4	96,4	102,0	171,5	122	167
3653.060	28	141,9	127,0	132,0	137,6	171,5	122	167

Kortin syvyys 220 mm

Til.nro RP	TE	Mitat (mm)						
		a	B	b	c	d	e	f
3 U								
3653.200	10	50,5	35,6	40,6	46,2	231,5	182	227
3653.210	12	60,6	45,7	50,8	56,4	231,5	182	227
3653.220	14	70,8	55,9	60,9	66,5	231,5	182	227
3653.230	21	106,3	91,4	96,4	102,0	231,5	182	227
3653.240	28	141,9	127,0	132,0	137,6	231,5	182	227