

Klimatisierung

Kühlgeräte

Dachaufbau-Kühlgeräte

TopTherm Blue e, SK 3359.XXX, SK 3382.XXX

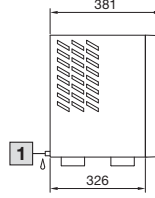
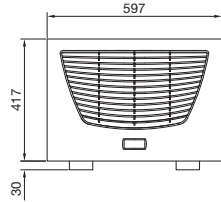
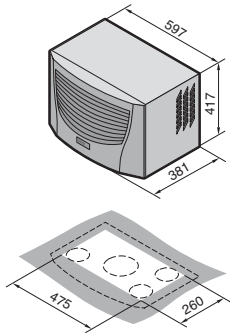

Montageausschnitt

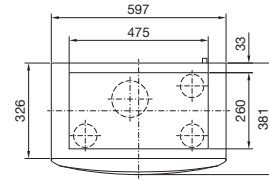

1 Kondensatablauf 1/2", flexibel

TopTherm Blue e, SK 3273.XXX, SK 3383.XXX, SK 3384.XXX, SK 3385.XXX

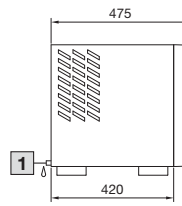
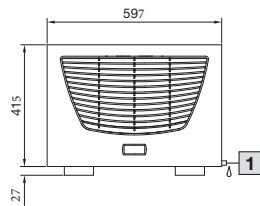
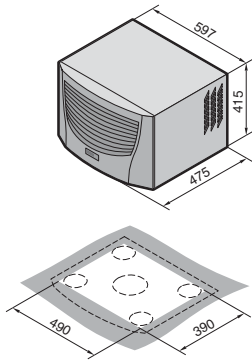

Montageausschnitt

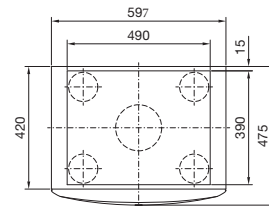

1 Kondensatablauf 1/2", flexibel

TopTherm Blue e, SK 3386.XXX, SK 3387.XXX

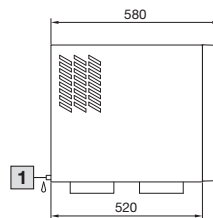
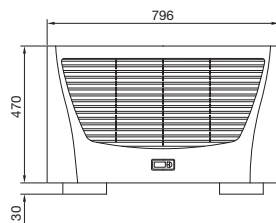
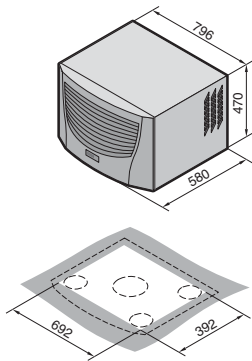

Montageausschnitt

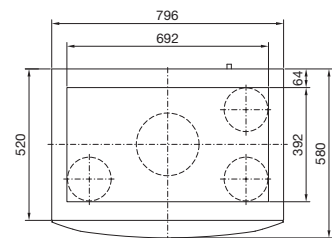

1 Kondensatablauf 1/2", flexibel

Dachaufbau-Kühlgeräte

Blue e+, SK 3185.730

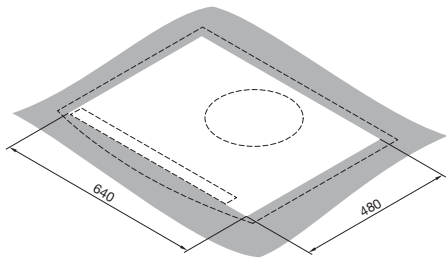
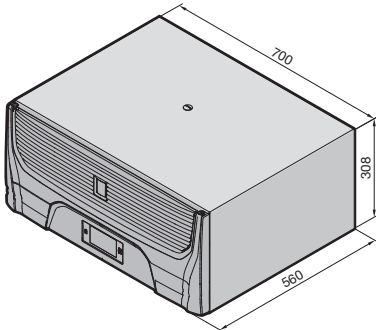

Montageausschnitt

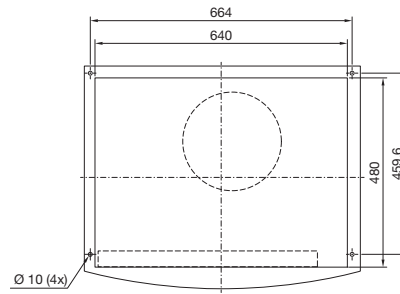

Hinweis:

Zur Montage muss der Schaltschrank mindestens die Abmessung 800 x 600 mm (B x T) haben.