

# Enclosures

## One-piece consoles TP

### One-piece consoles TP

Width 600/800 mm  
TP 6746.500, TP 6748.500

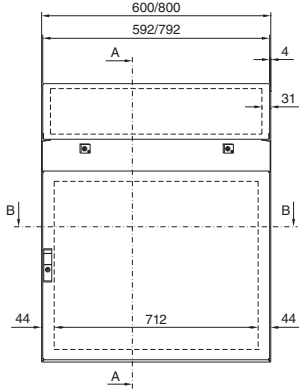

Width 1000/1200 mm  
TP 6740.500, TP 6742.500

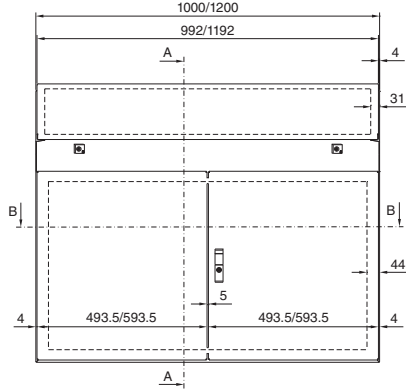

Section A - A

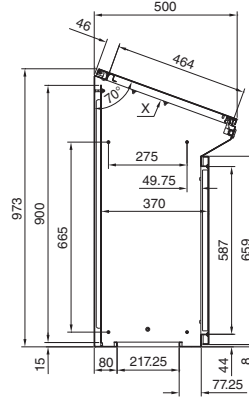

Mounting cut-out

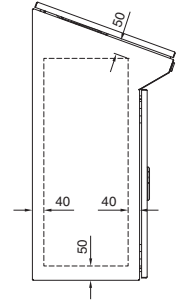

Section B - B

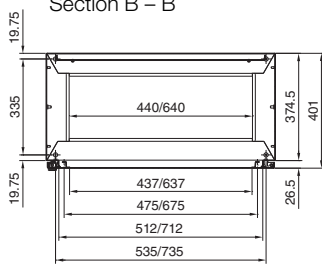

Section B - B

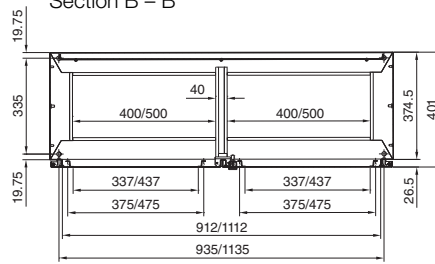

Mounting plate

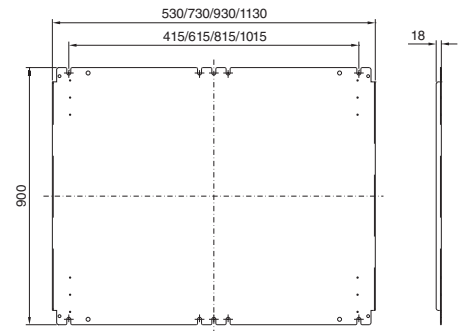

View in X direction

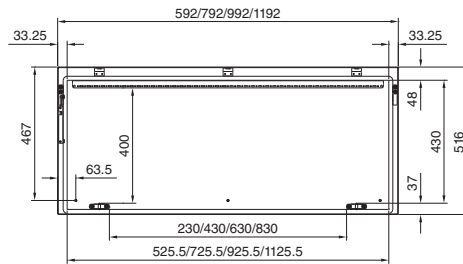

### Universal consoles TP

#### Sheet steel

With short front door  
TP 2694.500

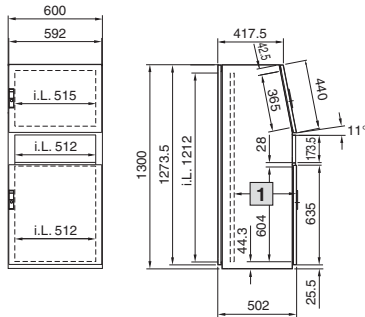

With tall front door  
TP 2695.500

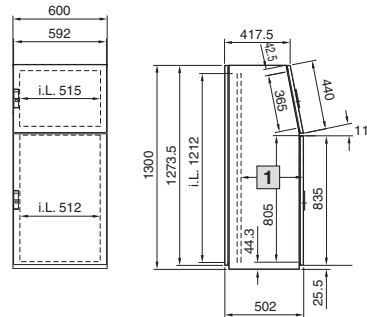

Mounting plate

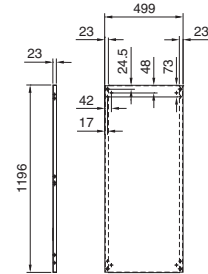

1 Adjustable from 200 to 400 mm  
on a 25 mm pitch pattern

i.L. = Clearance width