

### 总线箱体 BG

BG 1583.520, BG 1584.520, BG 1585.520, BG 1586.520

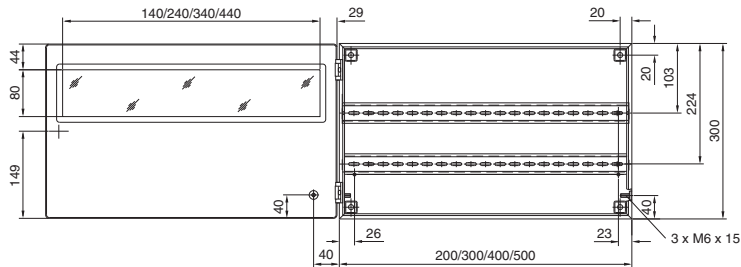

BG 1583.520

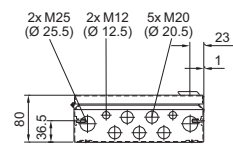

BG 1584.520

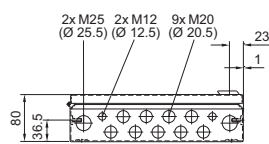

BG 1585.520

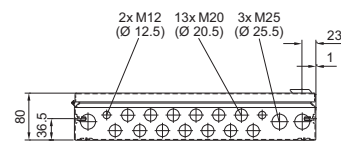

BG 1586.520

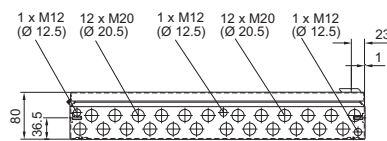

### BG 1605.520, BG 1606.520

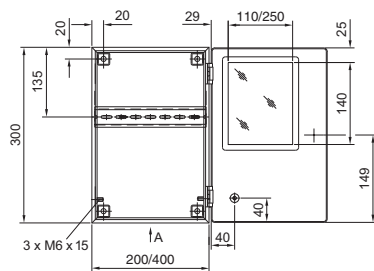

BG 1605.520

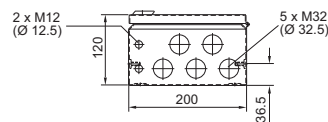

BG 1606.520

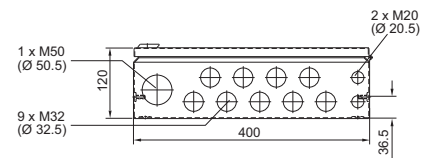

### BG 1558.510, BG 1559.510

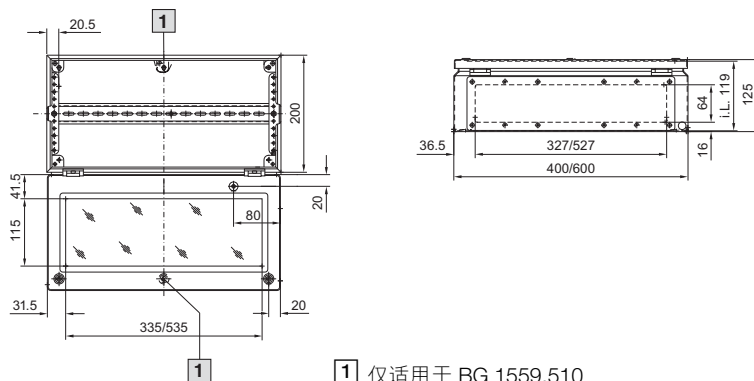

1 仅适用于 BG 1559.510

# 控制机柜

## 小型箱体

### 总线箱体 BG

BG 1577.XXX, BG 1578.XXX, BG 1579.XXX

型号 BG	尺寸 mm					视窗高度 mm	
	宽 (B)	高 (H)	深 (T)	F1	G1	H1	H2
1577.500	400	300	155	385	275	-	-
1577.530						190	42
1577.450						155	92
1578.500	600	300	155	585	275	-	-
1578.530						190	42
1578.450						155	92
1579.500	800	300	155	785	275	-	-
1579.530						190	42
1579.450						155	92

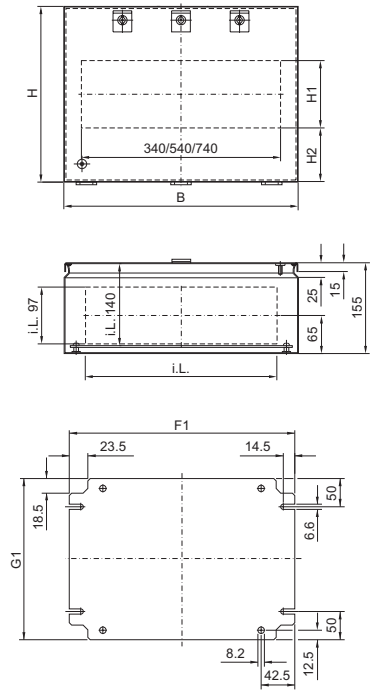

### BG 1611.510

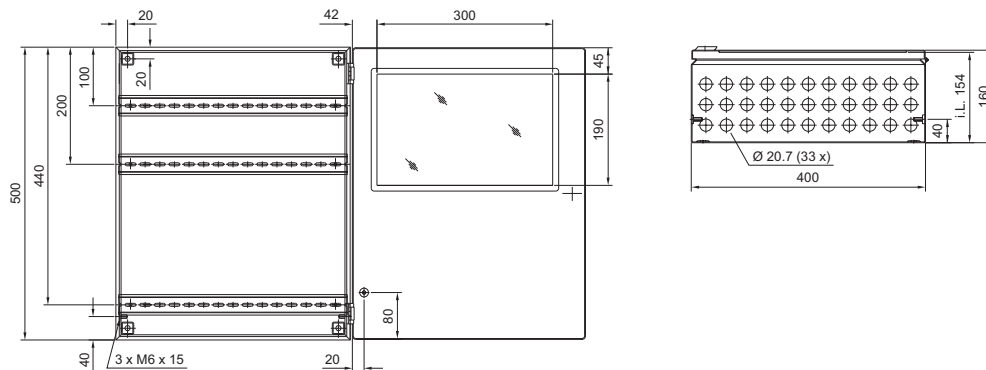

### BG 1609.510

