

Rittal – The System.

Faster – better – everywhere.

LCU DX



3311.490

3311.491

Valid for all units up to the following
serial number:

– 2021HA300S(R)-0126_A(B)

3311.492

3311.493

Valid for all units

Assembly and operating instructions

ENCLOSURES

POWER DISTRIBUTION

CLIMATE CONTROL

IT INFRASTRUCTURE

SOFTWARE & SERVICES

FRIEDHELM LOH GROUP



Foreword

Dear Customer,

Thank you for choosing a Rittal Liquid Cooling Unit DX (also referred to hereafter as "LCU DX").

This documentation applies to the following devices in the LCU DX series (DX = Direct Expansion):

- LCU DX 3 kW single
- LCU DX 3 kW redundant
- LCU DX 6.5 kW single
- LCU DX 6.5 kW redundant

Those sections where information only applies to one of the units are labelled accordingly in the documentation.

Please take the time to read this documentation carefully and pay particular attention to the safety instructions in the text and to section 2 "Safety instructions".

This is the prerequisite for:

- secure assembly of the LCU DX
- safe handling and
- the most trouble-free operation possible.

Please keep the complete documentation readily available so that it is always on hand when needed.

We wish you every success!

Your,
Rittal GmbH & Co. KG

Rittal GmbH & Co. KG
Auf dem Stützelberg

35745 Herborn
Germany

Tel.: +49(0)2772 505-0
Fax: +49(0)2772 505-2319

E-mail: info@rittal.de
www.rittal.com
www.rittal.de

We are always happy to answer any technical questions regarding our entire range of products.

Contents

1	Notes on documentation	4	6.4.2	Connecting the external unit	19
1.1	CE label	4	6.4.3	Connecting the internal unit	19
1.2	Information on electromagnetic compatibility	4	6.5	Checking the entire system prior to commissioning	19
1.3	Storing the documents	4	6.6	Installing the server	20
1.4	Symbols in these operating instructions	4	7	Operation	22
1.5	Associated documents	4	7.1	Control and display devices	22
1.6	Normative instructions	4	7.2	Switching the LCU DX on and off	23
1.6.1	Legal information concerning the operating instructions	4	7.2.1	Switching on the internal and external units	23
1.6.2	Copyright	4	7.2.2	Switching off the internal and external units	23
1.6.3	Revision	4	7.2.3	Switching off in an emergency	23
2	Safety instructions	5	7.3	Setting the setpoint temperature	23
2.1	Important safety instructions:	5	8	Troubleshooting	24
2.2	Service and technical staff	6	8.1	General	24
2.2.1	Personal safety equipment	6	8.2	List of error messages	24
2.3	Operator requirements	6	8.2.1	Control and display device 3	24
2.3.1	Abbreviated instructions	6	8.2.2	Control and display device 2	24
2.3.2	System log	6	9	Inspection and maintenance	25
2.3.3	F-gas regulation	7	10	Storage and disposal	26
2.3.4	Chemicals – Climate Protection Ordinance	7	11	Technical specifications	27
2.4	RoHS compliance	7	11.1	LCU DX 3 kW	27
3	Device description	8	11.2	LCU DX 6.5kW	28
3.1	General functional description	8	11.3	Information about the refrigerant	29
3.2	Air routing	8	11.4	Cooling output	29
3.3	Fault and operating hours changeover	8	11.4.1	LCU DX 3 kW	30
3.4	Device assembly	9	11.4.2	LCU DX 6.5 kW	31
3.4.1	Internal unit (evaporator coil)	9	11.5	Overview drawings	32
3.4.2	External unit (inverter-controlled cooling unit)	9	11.5.1	Internal unit LCU DX 3 kW and 6.5 kW	32
3.4.3	Refrigerant lines and electrical pilot wires	10	11.5.2	Dimensions of internal unit LCU DX 3 kW and 6.5 kW	33
3.5	Proper and improper usage	10	11.6	RI flow chart LCU DX	34
3.6	Scope of supply for the LCU DX	10	11.7	Circuit diagram	35
4	Transport and handling	11	11.7.1	Functional diagram, internal unit	35
4.1	Transport	11	11.7.2	Connection internal unit – external unit, external interfaces	36
4.2	Unpacking	11	11.7.3	Circuit diagram, external unit SK 3311.490 and SK 3311.491	37
5	Assembly and siting	12	11.7.4	Circuit diagram, external unit SK 3311.492 and SK 3311.493	38
5.1	General	12	11.8	Functional description of sensors	39
5.1.1	Siting location requirements	12	11.8.1	HaRed sensor (sensor 1)	39
5.1.2	Relative positioning of the internal unit to the external unit	12	11.8.2	EBM sensor to control the fan speed (sensor 2)	39
5.1.3	Supply connections required at the installation site	12	11.8.3	Temperature sensor in the Dixell controller (sensor 3)	39
5.1.4	Electromagnetic interference	12	11.8.4	Temperature sensor T1 (sensor 4)	39
5.2	Assembly procedure	12	11.8.5	Temperature sensors T2-T2C (sensors 5, 6 and 7)	39
5.2.1	Preparatory tasks	12	12	Spare parts	41
5.2.2	Mounting the internal unit	13	13	Accessories	42
5.2.3	Mounting the internal unit accessories	13	14	Glossary	43
5.2.4	Mounting the external unit	14	15	Customer service addresses	44
6	Installation	16			
6.1	General information	16			
6.2	Notes on pipework	16			
6.3	Connecting the condensate discharge	18			
6.4	Electrical connection	18			
6.4.1	General	18			

1 Notes on documentation

EN

1 Notes on documentation

1.1 CE label

The declaration of conformity has been issued by the company Rittal GmbH and is included with the supply of the LCU DX.

The cooling unit bears the following mark:



Rittal GmbH & Co.KG
Auf dem Stuetzelberg
35745 Herborn, Germany,
as manufacturers of the LXU DX split cooling units, are responsible for the content of these Instructions.

1.2 Information on electromagnetic compatibility

The LCU DX is a class A device as defined by EN 55022. Under certain circumstances, the device may cause radio interference in domestic environments. In such cases, the operator may be asked to implement appropriate measures.

1.3 Storing the documents

The assembly and operating instructions as well as all other applicable documents are an integral part of the product. They must be passed to those persons who are engaged with the unit and must always be available and on hand for the operating and maintenance personnel.

1.4 Symbols in these operating instructions

The following symbols are used in this documentation:



Danger!
Hazardous situation which will result in death or serious injury if the instructions are not followed.



Warning!
Hazardous situation which may lead to death or serious injury if the instructions are not followed.



Caution!
Hazardous situation which may lead to (minor) injuries if the instructions are not followed.



Note:

Information concerning individual procedures, explanations, or tips for simplified approaches. Also indicates situations which may result in material damage.

- This symbol indicates an "Action Point" and shows that you should perform an operation/procedure.

1.5 Associated documents

The general plant documentation for the room where the equipment is situated (construction specifications for the ventilation system) also applies in conjunction with these assembly and operating instructions.

1.6 Normative instructions

1.6.1 Legal information concerning the operating instructions

We reserve the right to make changes in content. Rittal GmbH & Co. KG and/or Hannich GmbH are not responsible for any damage which may result from failure to comply with these assembly and operating instructions. The same applies to failure to comply with the valid documentation for any accessories used.

1.6.2 Copyright

The distribution and duplication of this document and the disclosure and use of its contents are prohibited unless expressly authorised. Offenders will be liable for damages. All rights created by a patent grant or registration of a utility model or design are reserved.

1.6.3 Revision

Rev. 2 of 01/31/2020

2 Safety instructions

The devices in the LCU DX series are developed and manufactured with due regard for all safety precautions. Nevertheless, the unit still poses a number of unavoidable dangers and residual risks. These safety instructions provide an overview of these dangers and the necessary safety precautions.

In the interests of your own safety and the safety of others, please read these safety instructions carefully before assembling and commissioning the LCU DX!

Follow the user information found in these instructions and on the unit carefully.

2.1 Important safety instructions:



Danger! Electric shock!

Contact with live electrical parts may result in fatal injury.

Before switching on, ensure that there is no possibility of accidental contact with live electrical parts.

The unit has a high discharge current. Before connecting to the supply circuit, therefore, it is essential to make a 6 mm² earth connection (see section 11.7 "Circuit diagram").



Danger! Injury caused by fan impellers.

Keep persons and objects away from the fan impellers. Do not remove covers until the power supply is disconnected and impellers are immobilised. Always use mechanical protection when working. Shut down the respective fan during maintenance work, if possible. Tie long hair back. Do not wear loose clothing.

The fans will start up again automatically following a power disruption.



Danger! Hot components may cause injury!

The external unit and the pipelines are hot during operation, and may cause burns on direct contact.



Danger! Risk of poisoning from refrigerant gases created under the influence of heat.

When carrying out welding and soldering work, shortness of breath or asphyxiation may occur.

The refrigerant is heavier than air, and in high concentrations may cause shortness of breath and asphyxiation, by displacing the oxygen.



Danger! Risk of poisoning from refrigerant gases created under the influence of heat.

When carrying out welding and soldering work on the refrigerant circuit, use protective gloves and breathing apparatus with a filter.

Even a very low concentration of refrigerant may cause the refrigerant to decompose in combination with a naked flame, and cause acute shortness of breath.



Danger! Risk of injury from incorrect installation.

Installation of the refrigerant lines and other media connections must only be carried out by qualified plumbers or cooling technology specialists.



Danger! Threat to the environment from escaping refrigerant!

Never allow the refrigerant to escape into the environment if at all possible (see section 2.3.3 "F-gas regulation").



Danger! Injury due to falling loads!

Do not stand under suspended loads when transporting the unit with a hoist trolley, a forklift, or a crane.



Warning! Danger of cut injuries, especially from the sharp edges of the fan module and heat exchanger module.

Put on protective gloves before beginning assembly or cleaning work.

2 Safety instructions

EN



Warning! Injuries from escaping refrigerant.

Escaping gas may freeze the skin. Before working on the cooling circuit, put on protective gloves and goggles.



Caution! Risk of malfunction or damage! Do not modify the unit. Use only original spare parts.



Caution! Risk of malfunction or damage! Proper operation can only be ensured if the unit is operated under the intended ambient conditions. As far as possible, observe the ambient conditions for which the unit was designed, e.g. temperature, humidity, air purity.



Caution! Risk of malfunction or damage! All media required for the control system, such as the correct fill volume of refrigerant, must be available throughout the entire operating period of the device.



Caution! Risk of malfunction or damage! Installation, and in particular the laying of the refrigerant pipework between the internal and external unit, must only be carried out by trained, qualified and accredited cooling system specialists.



Caution! Risk of malfunction or damage! In order to prevent EMC-related malfunctions during operation, and to allow access for servicing purposes, cross-wiring through the LCU DX to the bayed racks is prohibited.

As a general requirement, please observe the following five safety rules to DIN EN 50110-1 (VDE 0105-1) when working in and on the LCU DX, in order to avoid accidents:

1. Switch off!
Switch off the on-site power supply to the LCU DX.
2. Secure against reactivation.
3. Ensure that all poles are de-energised.
4. Earth and short-circuit.
5. Cover or shield adjacent, live parts.

2.2 Service and technical staff

The installation, commissioning, maintenance and repair of this unit may only be carried out by trained, qualified mechanical, electro-technical and refrigeration engineering specialists.

Only properly instructed personnel may service a unit while in operation.

2.2.1 Personal safety equipment

Personal safety equipment, which should as a minimum include thermally insulated gloves and protective goggles, is to be worn during any work on this unit when personnel might come into contact with refrigerant (see section 11.3 "Information about the refrigerant").

Additionally, in the event of fire, airtight respiratory masks must be worn.

2.3 Operator requirements

In accordance with EU Regulation 842/2006, for a total refrigerant fill volume of more than 2.5 kg (R410A), the operator must carry out a leak test at least once a year. This fill volume is achieved or exceeded with a pipe length of > 28 m.

Any leaks that are detected must be repaired immediately.



Note:

Rittal offers leak testing of the device as a service.

2.3.1 Abbreviated instructions

The operator must ensure that abbreviated instructions containing the following information are available in a readily accessible location on the LCU DX:

1. Name, address and telephone number of the installation company, its customer service department, or the customer service department of the owner/operator, or as a minimum requirement, the individual responsible for the cooling system, together with the address and telephone number of the fire brigade, police, hospitals and burn victims centres.
2. Type of refrigerant: R410A, comprising 50% difluoromethane R32 (CH₂F₂) and 50% R125 pentafluoroethane (C₂HF₅);
3. Instructions for switching off the cooling system in an emergency (see section 7.2.3 "Switching off in an emergency");
4. The maximum permissible pressures (see section 11 "Technical specifications").

2.3.2 System log

Under DIN EN 378, the operator is required to keep a system log and ensure that it is regularly updated. The system log should contain the following information:

1. Details of all repair work
2. Quantity and type (new, reused or recycled) of refrigerant added, quantity of refrigerant removed

3. Outcome of any analysis of reused refrigerant, if available
4. Origin of reused refrigerant
5. Amendments to and replacement of system components
6. Results of all regular routine checks and
7. Any significant shutdowns

2.3.3 F-gas regulation

Regulation (EU) No. 517-2014 of the European Parliament and of the Council on certain fluorinated greenhouse gases entered into force on April 16, 2014. The Regulation regulates the reduction of emissions, the use, recovery and destruction of certain fluorinated greenhouse gases, and the labelling and disposal of products and equipment containing such gases.

Leak testing to chapter II, article 4 (leak checks)

For LCU DX systems, the operators are obliged to carry out leak checks as follows:

- Up to a total refrigerant fill volume of 2.5 kg R410A, corresponding to a system pipe length of up to 27 m, leak checks are not required.
- For pipe lengths of more than 27 m (system filling with >2.5 kg R410A), a leak check must be carried out at 12-month intervals, and in accordance with Article 6, log books (original operator log book and a copy of the log book from the overseeing refrigeration specialists) must be kept.

2.3.4 Chemicals – Climate Protection Ordinance

This Ordinance applies in addition to the aforementioned Regulation (EC) No. 842/2006 of the European Parliament and of the Council of 17 May 2006 on certain fluorinated greenhouse gases.

2.4 RoHS compliance

The LCU DX fulfils the requirements of EU Directive 2011/65/EC on the Restriction of Use of Certain Hazardous Substances in Electrical and Electronic Equipment (RoHS) of 8 June 2011.



Note:

Corresponding information about the RoHS Directive may be found on our website at www.rittal.com/RoHS.

3 Device description

3.1 General functional description

The Liquid Cooling Unit DX (DX = Direct Expansion) is essentially a split cooling unit used to dissipate heat losses from server enclosures or for the effective cooling of devices built into a server enclosure.

The air routing in the LCU DX supports the "front to back" cooling principle of the devices built into the server enclosure. The hot air expelled by the devices in the server enclosure is drawn in by the fans at the rear directly from the server enclosure or Micro Data Center and then routed through the heat exchanger module.

In the heat exchanger module, the heated air is directed through a heat exchanger (refrigerant evaporator), and its thermal energy (heat loss from the server enclosure) is removed from the refrigerant via evaporation. This process cools the air to a freely selectable temperature, and it is then routed directly in front of the 482.6 mm (19") level in the server enclosure or Micro Data Center.

The setpoint (outlet temperature from the cooling unit or server air intake temperature) may be set in the range +17 °C to +30 °C.

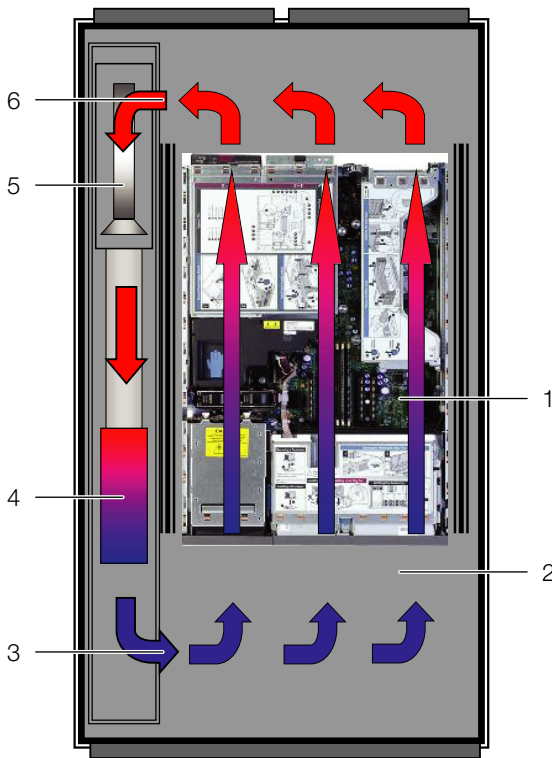

Fig. 1: Air routing on the LCU DX – Top view

Key

- 1 Installed equipment in the server
- 2 Server enclosure/Micro Data Center
- 3 Air outlet
- 4 Heat exchanger
- 5 Fan
- 6 Air inlet

In the LCU DX, the temperature of the incoming cold air (server air intake) is controlled by continuously compar-

ing the actual temperature with the setpoint temperature (preset to +22 °C).

If the actual temperature exceeds the setpoint temperature, the speed of the compressor is automatically increased, providing a greater cooling output from the heat exchanger, until the setpoint temperature is reached. The control range is ± 2 K from the setpoint. In the LCU DX, the measured temperature of the extracted warm air is used to determine and control the required fan speed.

Any condensate incurred is collected in the integral condensate collecting tray below the heat exchanger, and from there is routed outside via a condensate discharge hose.

3.2 Air routing

In order to achieve sufficient cooling in the server enclosure, it is important to ensure that the cooling air passes through the interior of the built-in devices rather than flowing past at the sides.

Targeted air routing inside the server enclosure has a major effect on the thermal output to be dissipated.

In order to ensure targeted air routing in the system, the server enclosure should be divided vertically into warm air and cold air sections. Essentially, this is already ensured by the 482.6 mm (19") arrangement and the installation of "front to back" vented servers. Consistent sub-division is achieved with additional plastic foam strips and air baffle plates on the left and right of the 482.6 mm (19") level (see section 13 "Accessories").



Note:

The 482.6 mm (19") level must likewise be completely sealed. This is already the case in a fully configured server enclosure. With a partially configured server enclosure, the open height units (U) of the 482.6 mm (19") level must be sealed with blanking plates, which are available as Rittal accessories (see section 13 "Accessories").

If the LCU DX is used to cool a TS IT server enclosure, it is important that this is sealed, by fitting the enclosure with side panels, roof and gland plates. Any existing cable entries should be sealed e.g. using suitable brush strips. Whilst the system is in operation, both the front and the rear doors should be kept completely shut. No slotted doors should be used.

When using in the Micro Data Center, the LCU DX is inserted in a sealed safe structure for application-related reasons.

3.3 Fault and operating hours changeover

For the redundantly designed units 3311.491 and 3311.493, it is possible to arrange for automated, timed changeovers between the two units A and B by means of DIP switch settings.

The following four settings are supported.

DIP switch 2 OFF and dip switch 3 OFF

There is **no** timed changeover between units A and B; cooling is only performed by unit A. Changeover to unit B only occurs in the event of a fault or a power failure on unit A.

DIP switch 2 ON and dip switch 3 OFF

An automatic changeover between units A and B occurs every 6 hours.

DIP switch 2 OFF and dip switch 3 ON

An automatic changeover between units A and B occurs every 12 hours.

DIP switch 2 ON and dip switch 3 ON (factory setting)

An automatic changeover between units A and B occurs every 24 hours.

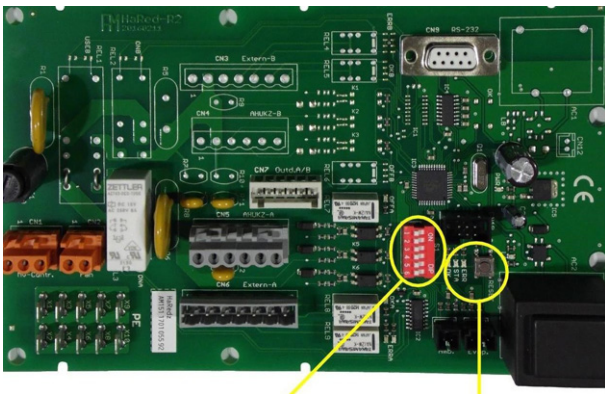

Furthermore, depending on the set changeover time, the system will switch to the stand-by unit in the event of a malfunction or power failure in the unit currently in operating mode.



Note:

Please note that during switching from one unit to another, the display switches off and the fans stop.

With redundant LCU DX units (3311.491 and 3311.493), the stand-by unit is additionally activated in the event of an overtemperature in the expelled air (>28 °C). In such case, both units are in cooling mode. This status is retained until the expelled air temperature drops back below 25 °C.

If the expelled air temperature exceeds the threshold temperature of 33 °C, the fault signal contacts will activate both units and report a fault. In such cases, both units will remain in cooling mode until an expelled air temperature of 18 °C is achieved. The system then automatically switches back to regular operation with one stand-by unit.

Regular operation can also be restored manually by pressing the reset button, which is located on the redundancy board adjacent to the DIP switches.

3.4 Device assembly

3.4.1 Internal unit (evaporator coil)

The internal unit of the LCU DX may be bayed either on the right or left of a server enclosure or Micro Data Center. To this end, the internal unit is mounted directly on fixing brackets on the rear wall of the evaporator coil. The evaporator coil has two condensate collecting trays to enable installation on the left or right of the enclosure. The bottom condensate discharge in each case remains unused.

The internal unit is comprised of the following components:

- Housing of powder-coated sheet steel.
- Two condensate collecting trays in the enclosure (bottom/top) so that the evaporator coil can be used in two installation positions. The discharge connection of the condensate tray has a diameter of 12 mm.
- Direct refrigerant evaporator coil of inner-grooved copper core pipes with aluminium membranes. The evaporator coil is pressurised with exhaust air from the server in order to ensure heat absorption (heat dissipation) via the refrigerant flowing into the copper pipes.
- Evaporator coil fan as linear controlled EC fan.
- Full electronic control of all components in the internal unit, for evaporator coil fan speed control, server intake air temperature control, and power demand from the external unit. The controller has temperature sensors built into the intake and exhaust side of the internal unit, as well as on the evaporator coil itself.
- Additional temperature sensor in the server front.

3.4.2 External unit (inverter-controlled cooling unit)

The external unit is comprised of the following components:

- Housing of weather-proof, stove-enamelled sheet steel.
- Compressor for compressing and circulating the refrigerant from the low-pressure side (internal unit) to the high-pressure side (external unit). The motor is activated by an external inverter, which controls the speed of the compressor and therefore allows the cooling output to be precisely adapted to the actual cooling requirement.
- Full electronic control of all components and measurement devices on the external unit, including various sensors and pressure measuring devices.
- Condenser for condensing the compressed refrigerant so that it can be returned to the evaporator coil via the expansion valve in liquid form. The condenser is comprised of copper core pipes with aluminium mem-

3 Device description

EN

branes and a DC fan motor, which is speed-controlled to adjust the output.

- Electronic expansion valve to supply the evaporator coil with the required volume of refrigerant, so as to ensure the corresponding optimum thermal absorption capacity to suit the current output requirements. The expansion valve is electronically regulated via the pilot wire from the evaporator coil.

3.4.3 Refrigerant lines and electrical pilot wires

The medium connection lines between the internal unit and the external unit are comprised of the following components:

- Pair of refrigerant lines as a refrigerant suction line (return) and refrigerant liquid line (inlet), including condensate insulation. Refrigerator-quality copper pipes should be cleaned and dried (to DIN EN 12735-1/DIN 1786) and sealed before use.
- Electrical and pilot wire lines between the internal unit and the external unit in a UV-resistant design.

3.5 Proper and improper usage

The LCU DX is used to dissipate low to medium heat losses and for the effective cooling of devices built into a server enclosure/Micro Data Center. The unit is designed solely for static use in sealed rooms.

The unit is state of the art and built according to recognised safety regulations. Nevertheless, improper use can pose a threat to the life and limb of the user or third parties, or result in possible damage to the system and other property.

Consequently, the unit must only be used properly and in a technically sound condition!

Any malfunctions which impair safety should be rectified immediately.

Proper usage also includes following the operating instructions and fulfilling the inspection and maintenance conditions.

Inappropriate use can be dangerous. Examples of inappropriate use include:

- Use of another external unit
- Improper operation
- Use of a refrigerant other than R410A
- Use of a refrigerant fill volume other than that specified
- Installation of the external unit in an unsuitable position
- Improper rectification of malfunctions
- Use of replacement parts which are not authorised by Rittal GmbH & Co. KG
- Non-static use, e.g. on moving or vibrating machines

3.6 Scope of supply for the LCU DX

The supply of an LCU DX in the "single" variant includes the following:

Qty.	Parts
1	LCU DX, ready to connect, consisting of:
1	Internal unit
1	Remote control/operating unit
1	Holder for operating unit (482.6 mm (19") console, 3 U)
1	Temperature sensor, server front (sensor 1)
1	Condensate discharge hose with copper siphon
1	External unit
1	Set of accessories for mounting the internal unit and for the air block panel
1	Assembly and operating instructions

Tab. 1: Scope of supply of an LCU DX, "single" variant

The supply of an LCU DX in the "redundant" variant includes the following:

Qty.	Parts
1	LCU DX, ready to connect, consisting of:
1	Internal unit
2	Remote control/operating unit
1	Holder for operating unit (482.6 mm (19") console, 3 U)
2	Temperature sensor, server front (sensor 1)
1	Condensate discharge
2	External unit
1	Set of accessories for mounting the internal unit and for the air block panel
1	Assembly and operating instructions

Tab. 2: Scope of supply of an LCU DX, "redundant" variant

4 Transport and handling

4.1 Transport

The LCU DX is delivered shrink-wrapped on a pallet.



Caution!

Because of its height and narrow base, the LCU DX is liable to tip over. Risk of toppling, especially after the unit is removed from the pallet!



Caution!

**Transportation of the LCU DX without a pallet:
Use only suitable and technically sound lifting gear and load-bearing devices with sufficient load capacity.**

4.2 Unpacking

- Remove the packaging materials from the unit.



Note:

After unpacking, the packaging materials must be disposed of in an environmentally friendly way. They consist of the following materials:

Wood, polyethylene film (PE film), strap, edge protectors.

- Check the unit for any damage that may have occurred during transport.



Note:

Damage and other faults, e.g. incomplete delivery, should be reported immediately, in writing, to the shipping company and to Rittal GmbH & Co. KG.

- Place the unit in its intended location.

5 Assembly and siting

5 Assembly and siting

5.1 General

5.1.1 Siting location requirements

To ensure proper functioning of the LCU DX, the following conditions for the siting location of the device must be observed.

Climatic conditions

■ When choosing a siting location for the internal unit and external unit, please observe the values prescribed in section 11 "Technical specifications" for the ambient temperature, dewpoint and air purity.

According to ASHRAE Directive TC 9.9, a maximum room temperature of 30 °C at 50% relative humidity must be observed at the internal unit's siting location. This equates to a dew point of 19 °C. If these limits are exceeded, there is a risk of condensation forming on the air outlet of the internal unit.



Recommendation:

Where necessary, these values should be achieved by installing an additional room air-conditioning system.

Floor conditions

- The floor of the installation space should be rigid and level.
- Choose the location carefully so that the unit is not situated on a step or uneven surface, etc.

Minimum required thermal output in the enclosure

In order to achieve continuous operation of the LCU DX, a heat load of at least 1 kW (3 kW version) or 3 kW (6.5 kW version) respectively must be installed in the enclosure. Otherwise, intermittent operation of the system may occur.

5.1.2 Relative positioning of the internal unit to the external unit

The internal unit and the external unit must be connected with a suitable copper pipe connection to DIN EN 378-2. The entire system must then be filled with refrigerant (cf. section 6.2 "Notes on pipework").

The following distances and geodetic height differences must not be exceeded when installing the internal unit and external unit:

Position	Distance
Maximum equivalent pipeline length	LCU DX 3 kW: 30 m LCU DX 6.5 kW: 50 m
Of which maximum height difference	LCU DX 3 kW: 20 m LCU DX 6.5 kW: 25 m

Tab. 3: Distances and height differences

5.1.3 Supply connections required at the installation site

Power is usually supplied to the external unit.

LCU DX 3 kW

Connection type	Connection description
Electrical connection LCU DX 3 kW	230 V, 1~, N, PE, 50 Hz
Electrical fuse provided by the customer	16 A, miniature circuit-breaker with C characteristic
Refrigerant connection	Copper pipework

Tab. 4: Supply connections for the LCU DX 3 kW

LCU DX 6.5 kW

Connection type	Connection description
Electrical connection LCU DX 6.5 kW	230 V, 1~, N, PE, 50 Hz
Electrical fuse provided by the customer	20 A, miniature circuit-breaker with C characteristic
Refrigerant connection	Copper pipework

Tab. 5: Supply connections for the LCU DX 6.5 kW



Note:

Both the incoming line and the lines that connect the external and internal unit must be of a UV-resistant design.

5.1.4 Electromagnetic interference

- Interfering electrical installations (high frequency) are to be avoided.

5.2 Assembly procedure

5.2.1 Preparatory tasks



Note:

Installation in a Micro Data Center is described in the assembly instructions for the Micro Data Center. The assembly parts required for the internal unit are included with the supply of the Micro Data Center.

The internal unit may be mounted both on the right and on the left of the TS IT server enclosure.

Viewed from the operator side of the enclosure, if the LCU DX is fitted on the **right-hand** side of the enclosure, the refrigerant lines are routed out of the evaporator coil enclosure **at the top**. If the LCU DX is fitted on the **left-hand** side of the enclosure, the refrigerant lines are routed out of the evaporator coil enclosure **at the bottom**.

Before the internal unit of the LCU DX can be installed in a TS IT server enclosure, the following work should be carried out.

- Slide the 482.6 mm (19") mounting angles 50 mm away from you.



Note:

The LCU DX may only be operated in combination with 482.6 mm (19") mounting angles. Installation with a 482.6 mm (19") mounting frame is not possible.

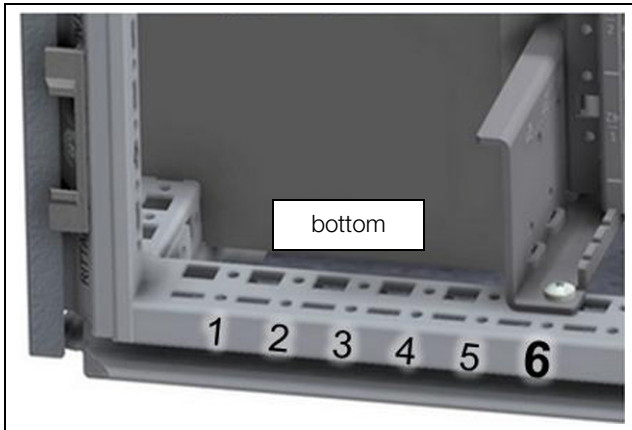

Fig. 2: Move the 482.6 mm (19") level sideways

- Ensure that the front distance from the 482.6 mm (19") mounting angle to the front edge of the TS frame is at least 100 mm.



Fig. 3: Move the 482.6 mm (19") level in the depth

- Position the punched section with mounting flange and attach it to the inner level of the TS frame (mounting side).
 - TS punched section with mounting flange 23 x 73 mm for enclosure depth 1000 mm: 8612.500, packs of 4
 - TS punched section with mounting flange 23 x 73 mm for enclosure depth 1200 mm: 8612.520, packs of 4

- Remember to maintain a distance of at least 15 cm between the roof plate and the top edge of the internal unit.
- Locate the two mounting devices supplied loose for installing the internal unit into the lower punched section with mounting flange.

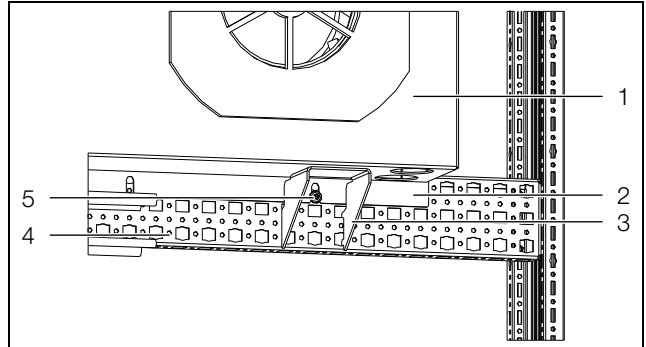

Fig. 4: Arrangement of the internal unit

Key

- 1 Internal unit
- 2 Rear wall of internal unit
- 3 Mounting device
- 4 Punched section with mounting flange
- 5 Assembly screw

5.2.2 Mounting the internal unit

- Position the internal unit on the mounting devices in such a way that the air outlet opening is on the operator side of the server enclosure, and the fans are in the rear section.

The end face of the internal unit must be flush with the front edge of the TS frame.

- Align the internal unit horizontally.
- In this position, screw the internal unit to the punched section with mounting flange using the attachment points provided (at the top and bottom of the rear panel).

5.2.3 Mounting the internal unit accessories

- Install the remote control (3 U trim panel) with the built-in operating units at the top of the 482.6 mm (19") level, on the maintenance side of the rack.

5 Assembly and siting

EN

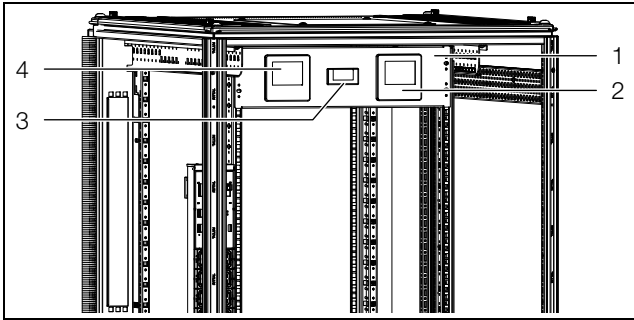

Fig. 5: Mounting the internal unit accessories

Key

- 1 Remote control (3 U trim panel)
- 2 Control and display device 1
- 3 Control and display device 2
- 4 Second control and display device 1 for "redundant" version

■ For the "single" version, fit the external temperature sensor included with the supply in a suitable position in front of the server installations.

We recommend positioning the temperature sensor in the middle, on the side opposite the outlet opening of the evaporator coil.

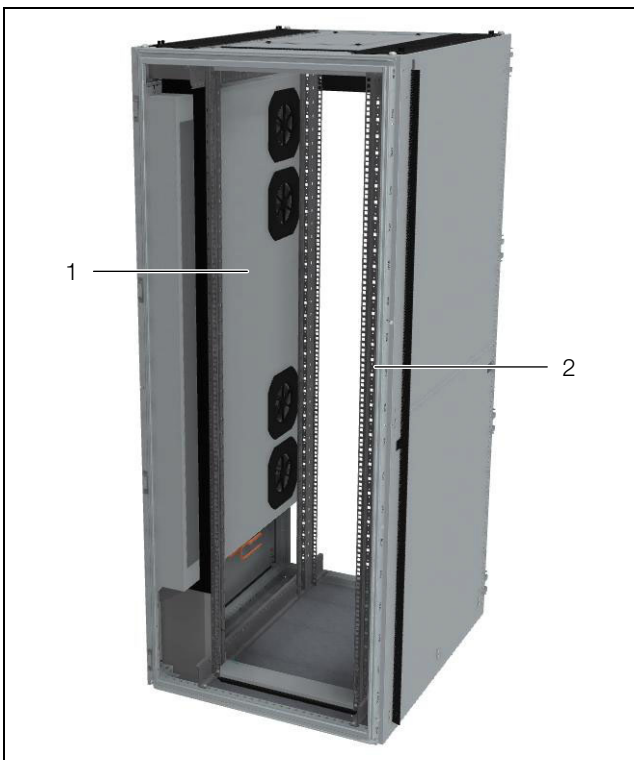

Fig. 6: Positioning of the external temperature sensor

Key

- 1 Evaporator coil
- 2 Central position on the opposite side

Depending on the components installed by the customer (thermal loads, outlet direction of hot air etc.), it may also be expedient to position it elsewhere according to the individual case.

■ For the "redundant" version, fit the second external temperature sensor included with the supply in the same position.

5.2.4 Mounting the external unit

The external unit may be secured to a solid wall or onto a flat roof or concrete surface using wall brackets (accessory, not included with the supply).

Please observe the following instructions regarding the installation site:

- The external unit is weather-resistant and may therefore be installed completely in the open air, with no need for a weather protection canopy etc.
- For continuous operation, the base surface must rise above the snow zone.
- It is also important to ensure that foreign bodies such as leaves cannot be drawn into the external unit.
- The external unit must not be exposed to extreme wind conditions, otherwise the heat exchanger could be excessively under-cooled, or the fan would need to work against the wind and be unable to move the required volume of air.
- If necessary, a wind break should be installed at a distance of 1 m from the device.
- If the unit is installed underneath a canopy, there must be a distance of at least 2 m between the floor and the canopy.

The following distances should be observed for maintenance purposes:

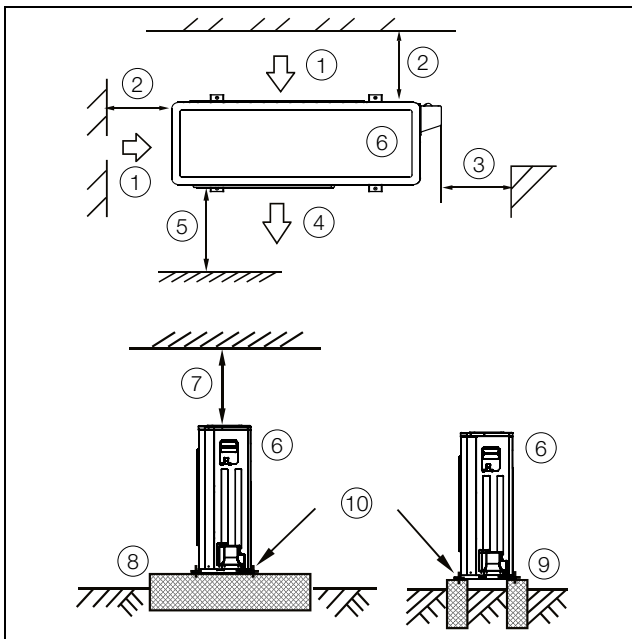

Fig. 7: Distances from external unit

Key

- 1 Air inlet
- 2 Distance > 300 mm
- 3 Clearance for maintenance: Distance > 600 mm
- 4 Air outlet
- 5 Distance > 200 mm
- 6 External unit
- 7 Distance > 600 mm
- 8 Roof area/foundations
- 9 Strip foundation
- 10 Assembly screws/vibration dampers

- The installation site of the external unit must be carefully selected to ensure an adequate supply and distribution of the airflow, even in unfavourable conditions.
- Install the external unit on brackets, remembering to observe the required minimum distance from the wall.
- Attach the external unit to the base plate to avoid the risk of tipping over.

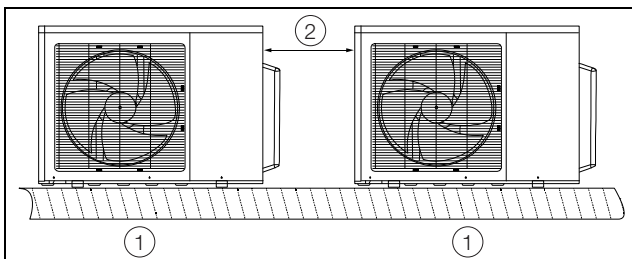

Fig. 8: Attachment points for external unit

Key

- 1 4 x M10 plugs per external unit
- 2 Distance > 600 mm

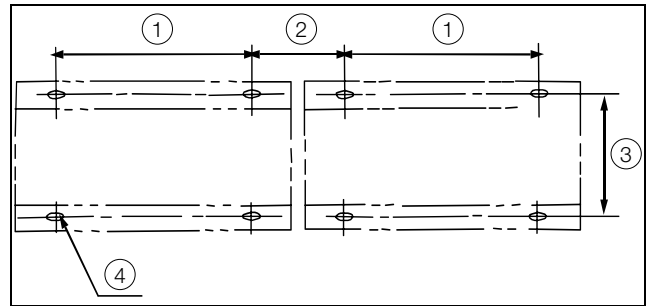

Fig. 9: Top view of attachment points

Key

- 1 For 3 kW unit: 514 mm
For 6.5 kW unit: 540 mm
- 2 Distance 1000 mm
- 3 For 3 kW unit: 340 mm
For 6.5 kW unit: 350 mm
- 4 12 x 20 mm elliptical drilled holes

6 Installation



Caution! Risk of malfunction or damage! Installation work, particularly the laying of the refrigerant pipework between the internal and external unit of the LCU DX, must only be carried out by trained, qualified and accredited cooling system specialists.

6.1 General information

The internal unit and the external unit must be connected with suitable copper pipework. With the TS IT server enclosure, this pipework can either be inserted into the enclosure from above or from below.

When using in a Micro Data Center, a cable duct is provided and this must be used for inserting the pipework into the safe.

In its delivered state, the internal unit is filled with 1.5 bar nitrogen. It is therefore crucial that the following steps are carried out in the order shown.



Note:

Installation of the pipework, creation of a vacuum and filling with refrigerant must only be carried out by qualified, accredited specialists in accordance with the valid technical regulations.

Furthermore, when carrying out the installation, it is important to observe all the pipework instructions in section 6.2.

6.2 Notes on pipework

The following basic rules should be observed when connecting the internal unit and external unit.

General information

1. The pipes may only be made from special copper piping that has been cleaned on the inside and sealed at both ends. The material of the copper pipework must comply with the specifications outlined in EN 12735-1 / EN 12735-2 and DIN 8964-3.
2. The external diameters of the copper pipes for the intake gas line from the internal unit to the external unit, as well as the liquid line from the external unit to the internal unit, must comply with the values given in section 11 "Technical specifications".

In order to ensure the correct spatial arrangement of the pipework, particular consideration should be given to the position of the individual pipes, the flow conditions (two-phase flow, oil transportation in part-load operation), condensation processes, thermal expansion, vibration, and good accessibility.



Note:

Routing and support of the pipework has a significant influence on a cooling system's operational reliability and service-friendliness.

As a general rule, pipelines should be laid in such a way as to prevent damage associated with routine activities. For safety reasons, and in order to protect the environment, the following aspects should be taken into account when laying pipework:

1. There must not be any threat to human safety, i.e. escape and emergency vehicle routes must not be obstructed or restricted in any way. No detachable connections or fittings must be positioned in publicly accessible areas.
2. Pipework should be protected from the thermal influence of hot lines and heat sources by means of spatial separation.
3. Refrigerant lines must be protected or covered if there is a risk of damage.
4. Flexible connecting parts such as connection lines between indoor and outdoor devices that could become displaced during regular work operations must be protected against mechanical damage.
5. The maximum distance between the supports of the copper pipes is 1 m for pipelines with 1/4" to 3/8", 1.25 m for pipelines with 1/2" to 5/8" and 2 m for pipelines with 3/4" to 7/8".

Laying the pipework

1. The equivalent length of the overall line between the internal unit and the external unit must not exceed the maximum length as set out in section 11 "Technical specifications". To calculate the equivalent length, in addition to the actual length of the pipeline, you should also make allowance for the equivalent length of curves and valves.
2. The number of curves should be kept to a bare minimum so as to avoid pressure losses. Where curves are unavoidable, the radius chosen should be as large as possible.
3. Generally speaking, the lines between the internal unit and external unit should take the shortest possible route. Exceptions are only admissible to avoid unnecessary bends or circumvent extreme heat sources.
4. Where possible, refrigerant lines should not be routed through rooms where people spend a lot of time, such as offices or meeting rooms.
5. The intake gas line must be laid with an incline of 1% in the direction of flow of the refrigerant.
6. When laying refrigerant lines, please ensure that there is no overarching of liquid lines and no dipping of gas lines (intake gas line). Oil could collect here, or in the case of the liquid line, gas bubbles could form.

- For intake gas lines laid vertically with the direction of flow pointing upwards (external unit is above the internal unit), an oil elevation arc should be provided at least every 3 m of line length. The pre-insulated pairs of lines may be laid with no distance between them.

Protecting the pipework

- Suitable precautions should be taken to prevent excessive vibrations or pulsations. In particular, care should be taken to prevent the direct transmission of noise or vibrations onto or through the supporting structure and the connected devices.



Note:

Vibrations and pulsations should be assessed with the system operational at maximum condensation temperature and when switching the system on and off, which has unfavourable impacts on the pipework.

- Safety devices, pipework and fittings should be protected from unfavourable environmental influences as far as possible. Due consideration should be given to unfavourable environmental influences, such as the risk of water collecting, relief lines freezing, or dirt and waste accumulating.
- With long pipelines, adequate precautions should be taken with regard to expansion and contraction.
- The pipelines of cooling systems should be designed and laid in such a way that the system cannot be damaged by liquid slugging (hydraulic shock).
- Pipelines with detachable connections must not be positioned in public thoroughfares, vestibules, stairwells, steps, entrances, exits or in ducts or shafts with unsecured openings to such areas, unless protected against disconnection.
- Pipelines without detachable connections, valves, control and regulatory devices that are protected against accidental damage may be positioned in public thoroughfares, stairwells or vestibules, provided they are situated at least 2.2 m above the ground.

Pipe supports

- Both horizontal and vertical lines must be laid with vibration-damping elements (such as rubber seals). These must be used at a spacing of at least 2 m.
- Take care to ensure that the first pipe support behind the internal unit and in front of the external unit does not exert any mechanical pressure (via the pipe) on the component. Pipe supports must not be located too close to bends, to give the lines space to expand.

Create the pipework system

- To create the refrigerant pipework system, open the ends of the lines on the internal unit. Upon opening, gas should flow out audibly (from the nitrogen filling provided in the factory) as an indication that there are no leaks in the cooling circuit.



Note:

The internal unit is pressurised (filled with protective gas)!

- Only cut pipes to length using a pipe cutter.
- Never saw pipes, as this could create swarf.
- Only solder pipes under nitrogen or helium! To this end, allow dry inert gas to flow into the pipe at one end of the pipeline which has already been created. Before starting, introduce a powerful current, reduce this to a minimum when you start soldering, and maintain this weak flow of protective gas throughout the entire soldering process.
- Before soldering the final connection, loosen the screw connection on the external unit, or leave it un-tightened throughout, so that overpressure cannot build up in the pipeline system. Immediately after soldering, tighten the screw connection.
- The pipelines may only be connected to the external unit with flares. However, flare connections should be restricted to soft pipes! After cutting the pipes to length, adjust to the correct internal diameter with light flaring. The flares must be tightened with the prescribed torque using a torque wrench.

Low-temperature insulation of the liquid line and intake gas line

- Both lines outside and inside the building should be equipped with low-temperature insulation to DIN 4140 made from UV-resistant HT/Armaflex or an equivalent material.
- We recommend a wall thickness of 9 mm

Leak test / conducting the leak test

The system must undergo leak testing as a complete system. A test should also be carried out on site once the installation is complete.

Multiple techniques may be used to test for leaks, depending on the manufacturing conditions, such as pressurisation with inert gas. In order to avoid emissions of hazardous substances, the pressure test may be carried out with inert gas such as nitrogen or helium. Oxy-acetylene and hydrocarbons must not be used for safety reasons. Air and gas mixtures are to be avoided, since certain mixtures may be hazardous.

The manufacturer must select a test method which allows suitable results to be achieved in accordance with the requirements outlined below.

Connections must be checked with a detector or using a technique with a detection sensitivity as described in

6 Installation

EN

EN 1779 with a bubble test (application of liquid) if the test pressure is 1 x PS.



Note:

Lower test pressures are admissible, provided there is an equivalent detection sensitivity.

The manufacturer must verify that the test method used complies with the aforementioned requirements.

EN 1779:1999 may be used as a basis for this test.

The detector must be calibrated at regular intervals as per the manufacturer's instructions.

Any leak detected must be repaired and subjected to a further leak test.

1. Systems with dry nitrogen should be tested at a maximum overpressure of 28 bar. When doing so, the shut-off valves on the external unit should remain closed. The external unit is pre-filled with refrigerant and this must not be allowed to escape.
2. Check the complete pipe network and the system parts for leaks. We recommend using Nekal spray to check every connection, including screw connections, for leak-proofness.

Evacuating

1. After checking for leaks, remove the air from the system. To do so, connect a vacuum pump and evacuate to a pressure of < 0.3 mbar (absolute pressure).
2. Break the vacuum at least twice, refill the system with nitrogen, and evacuate again. Where possible, implement double-sided evacuation of the suction side and the pressure side of the compressor, to which end a test/measurement connection must be made in the liquid line.

Filling with refrigerant

1. The external unit is prefilled in the factory, the fill volume is adequate for a 5 m line pair. For longer pipe lengths, additional refrigerant should be added in accordance with section 11 "Technical specifications".
2. The system must only be filled gravimetrically (i.e. by weight) using refrigerant as the liquid in the liquid line. Only liquid R410A should be added. Afterwards, switch on the device and whilst it is running, continue carefully restricted filling via the intake side of the external unit until the required fill volume has been added.
3. The set volume of refrigerant is determined by weighing the refrigerant bottle during the filling process.
4. The additional fill volume or the new total fill volume should be noted on the rating plate and operating manual.

6.3 Connecting the condensate discharge

Any condensate which may develop is collected in the condensate collecting tray of the internal unit. For universal use, the internal unit has two condensate collecting trays which may be fitted on the left or right of the enclosure, depending on the installation position.

- Connect the discharge hose supplied loose (internal diameter 12 mm) at the bottom connection (external diameter 12 mm).

The tray at the top is not used.

- Route the discharge hose to a drain with odour seal provided by the customer, so that any condensate can be discharged from the device.



Note:

In order to ensure safe condensate discharge, the following points should be observed:

- Lay the discharge hose so that it always runs downhill and without any kinks.
- Do not constrict the hose cross-section.

6.4 Electrical connection

6.4.1 General



Note:

Please keep the wiring plan readily available so that it is always on hand when needed. This is the only authoritative documentation for this unit.

The electrical connection can only be made on the external unit. The internal unit is supplied with power via the external unit. A 3-wire power cable should be used for this purpose. The corresponding pilot wires from the internal unit to the external unit should be laid with the refrigerant lines in accordance with section 11.7 "Circuit diagram".



Caution!

Work on electrical systems or equipment may only be carried out by an electrician or by trained personnel under the guidance and supervision of an electrician. All work must be carried out in accordance with electrical engineering regulations.

Contact with live electrical parts may result in fatal injury.

The unit may only be connected after the aforementioned personnel have read this information!

Use only insulated tools.

**Caution!**

Follow the connection regulations of the appropriate electrical power company.

The voltage specified in the wiring plan or on the rating plate must match the mains voltage.

The unit has a high discharge current. Before connecting to the supply circuit, therefore, it is essential to make a 6 mm² earth connection (see section 11.7 "Circuit diagram").

The pre-fuse specified in the wiring plan / rating plate should be provided to protect the cable and equipment from short-circuits. The unit must be individually fused.

The unit must be connected to the mains using an all-pole red/yellow isolating device as described in DIN EN 60335-2-40, which ensures at least 3 mm contact opening when switched off.

No additional control equipment may be connected upstream of the device at the supply end.

6.4.2 Connecting the external unit

Power is supplied to the external unit via a 3-wire connection cable (230–240 V, 1~, N, PE). As external units are generally sited outdoors, a UV-resistant cable should be used.

- Strip approximately 45 mm from the rubber sheathing of the connection cable.
- Trim the neutral conductor (N) and the phase conductor (L) to a length of approximately 35 mm. Leave the length of the PE conductor at approximately 45 mm.
- Remove approximately 9 mm from the insulation of all conductors with a suitable tool.

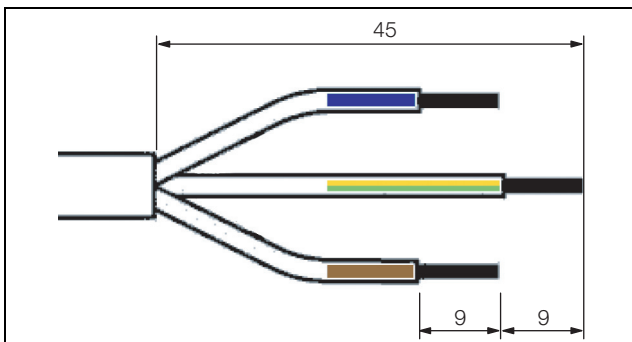

Fig. 10: Dimensions for removing the rubber sheathing and insulation

- Attach wire end ferrules without insulating collar to the ends of the cables, using a four-jaw pressing tool.
- Insert the cable into the connection box in the device from below.
- Attach the cooling unit to the strain relief provided.
- Connect the cable in the connection box as shown in the circuit diagram in section 11.7 "Circuit diagram" to the correspondingly labelled terminals (PE, L1, N).

**Danger!**

Take utmost care not to short-circuit the phase conductor with the zero conductor or the earth conductor. Otherwise, there is a risk of damage or injury.

- Connect the external units using an all-pole isolating device as described in DIN EN 60335-2-40. This disconnecter device must ensure at least 3 mm contact opening when switched off.
- The customer should provide a pre-fuse in the supply line to the external unit, as specified on the rating plate of the device.

6.4.3 Connecting the internal unit

Connecting the internal unit simply entails connecting the cables routed from the external unit, which comprise a data line and a 230 V pilot wire as described in section 11.7 "Circuit diagram".

The fault signals may be picked off at the internal unit (floating contacts).

- Should you wish to switch the internal unit on and off via a remote switch (e.g. for an external fire shutoff), connect a remote contact (normally open contact) in the electronic box to terminals L1 and 11 for the "single" version and terminals L1 and 11 as well as L2 and 23 ("remote" or "ON/OFF") for the "redundant" version (see section 11.7.2 "Connection internal unit – external unit, external interfaces"). In the closed state, the system is then deactivated.

If both terminals are jumpered, the status message "– –" will appear in the display.

6.5 Checking the entire system prior to commissioning

Before operating the cooling system, the entire system, including the complete cooling system, must be checked for conformity with the relevant diagrams, system flow charts and piping and instrumentation diagrams, and wiring plans.

Cooling systems must be checked by a trained plant inspector (as defined in EN 13313) and should include a review of the following points:

1. Inspect the documents.
2. Check the safety switchgear for pressure limiting to ensure that the safety switchgear for pressure limiting is operational and correctly installed.

6 Installation

EN

3. Check selected hard solder connections on pipe-work for compliance with EN 14276-2.
4. Check the refrigerant pipelines.
5. Inspect the report on the cooling system leak test.
6. Visually inspect the cooling system.
7. Check the labels.

This inspection must be documented; see EN 378-2, section 6.4.3. No cooling system may be operated without the correct documentation.

The installer must document the fact that the system was installed in accordance with the construction requirements and state the safety and control device settings, if adjustable, following commissioning. This documentation must be kept by the installer and presented upon request.

6.6 Installing the server

As a general rule, the cooling system is designed for "front to back" cooling – in other words, the devices installed in the enclosure must likewise follow this air routing. To this end, the area in front of the 482.6 mm (19") level is supplied completely with cold air. The servers draw the cooling air they require from this area, and expel the warm air downwards or sideways. The area at the rear may reach a high temperature. This is intentional, since it increases the transmission performance of the heat exchanger in the internal unit.

- Distribute the equipment you wish to install evenly across the 482.6 mm (19") level.
- Close any areas you do not require with 482.6 mm (19") blanking plates.
- Cover the side opposite the internal unit in the enclosure with an air baffle plate (see section 13 "Accessories").

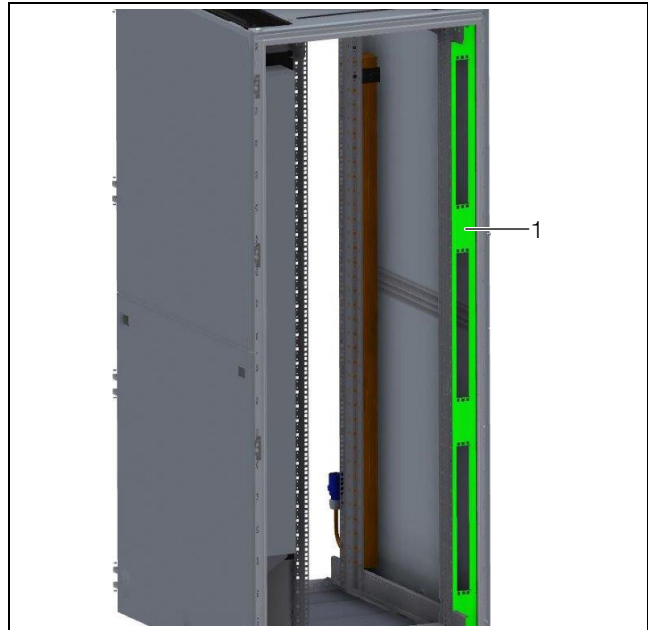

Fig. 11: Air baffle plate on the side opposite the LCU internal unit

Key

- 1 Air baffle plate

- Exchange the brush strip of the standard air baffle plate in the TS IT server enclosure for the brush strip with shorter brushes included with the supply of the LCU DX.
The brush strip is included with the supply in two parts.
- Remove the top corner of the air baffle plate near the TS frame using an angle grinder or other suitable tool.

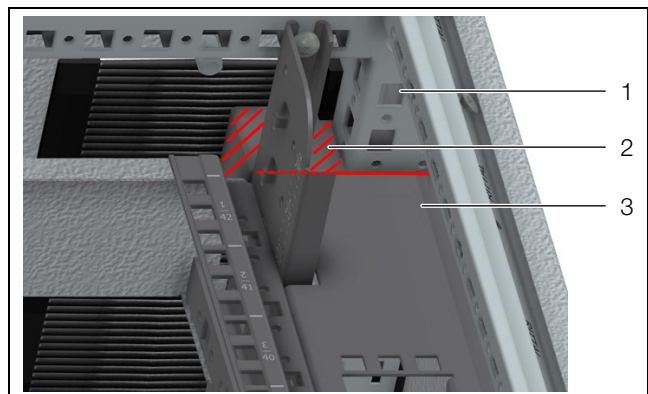

Fig. 12: Cut-out in the air baffle plate

Key

- 1 TS frame
2 Cut-out for TS frame
3 Air baffle plate

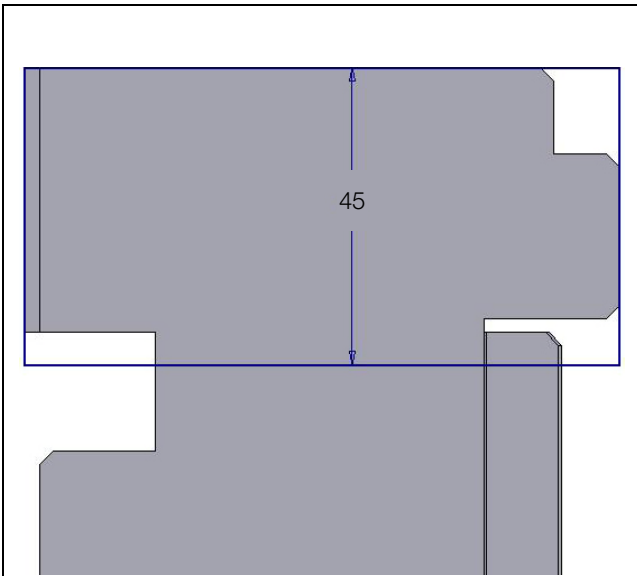

Fig. 13: Dimensions of the cut-out

- Partition the remaining gap between the 482.6 mm (19") level and the internal unit, as well as above and below the internal unit, using the foamed plastic supplied loose with the LCU DX.
- Cut the foamed plastic to the required size.

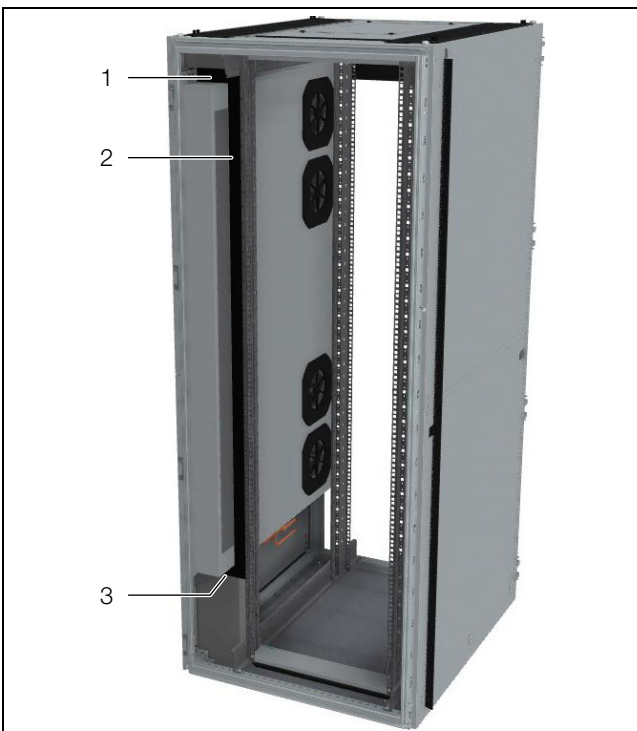

Fig. 14: Partitioning with foamed plastic pieces on the side of the LCU internal unit

Key

- 1 Partitioning above
- 2 Partitioning inside
- 3 Partitioning below

7 Operation

EN

7 Operation

This section describes operation of the LCU DX using the control and display devices.

7.1 Control and display devices

Control and display device 1 is located in the 3 U trim panel on the maintenance side of the rack. In the "single" version, there is one such display device installed, and in the "redundant" version there are two.

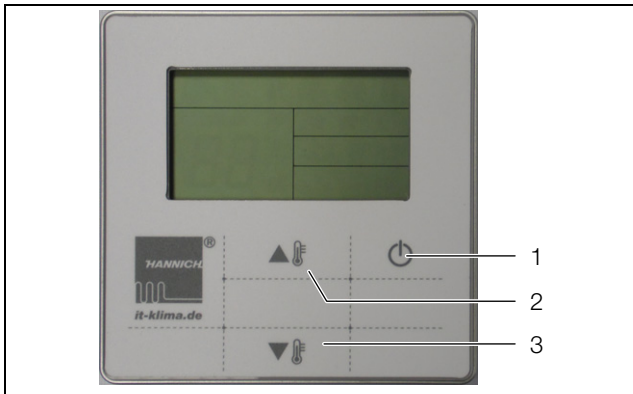

Fig. 15: Control and display device 1

Key

- 1 ON/OFF button
- 2 "Up" button (temperature)
- 3 "Down" button (temperature)

Pressing the arrow keys 2 and 3 simultaneously for 3 seconds activates the key lock of the control and display device. To deactivate the key lock, the two keys must be pressed simultaneously again.

Following an interruption to the power supply, the key lock will be reset automatically and will need to be reactivated.

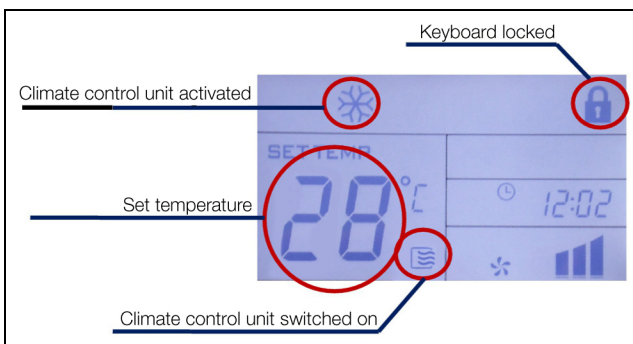

Fig. 16: Description of the display

Control and display device 2 is likewise located in the 3 U trim panel on the maintenance side of the rack. In both the "single" version and in the "redundant" version, there is only one control device of this type installed.

In addition to control and display device 1, control and display device 2 regulates the start-up response following a power failure or if the minimum cooling load is undercut.

The temperature sensor on control and display device 2 (Dixell controller – sensor 3) is positioned inside the evaporator coil on the outlet grille, and measures the evaporator coil outlet temperature and the server inlet temperature (fig. 6). It controls the magnetic valve (see section 11.6 "RI flow chart LCU DX"). If the evaporator coil outlet temperature drops 0.1 °C below the set value, the magnetic valve will be closed. The refrigerant in the pipeline is extracted, and in the evaporator coil of the internal LCU DX unit, evaporation ceases after a short time. The evaporator coil package is heated by the server outlet air. As soon as the temperature of the evaporator coil outlet air exceeds the setpoint, the Dixell controller will open the magnetic valve again. This process limits the lowest temperature of the air expelled from the LCU DX.



Fig. 17: Control and display device 2

Key

- 1 "Up" button (temperature)
- 2 "Down" button (temperature)
- 3 ON/OFF button (deactivated)
- 4 Set button
- 5 Defrost switch (deactivated)
- 6 Light (deactivated)



Fig. 18: Sample display

A "frost star" appears in the top left of the control and display unit if the magnetic valve for protection against undercooling is open (the outlet temperature is within the required range). The "fan" display has no function.

Control and display device 3 is located on the end face of the internal unit. In the "single" version, there is one such control and display device installed, and in the "redundant" version there are two.

The operating status can be read from control and display device 3 on the internal unit. In addition to the control lights for operation, malfunction and defrost, the set temperature or a fault code can be read from the two-digit LCD display.

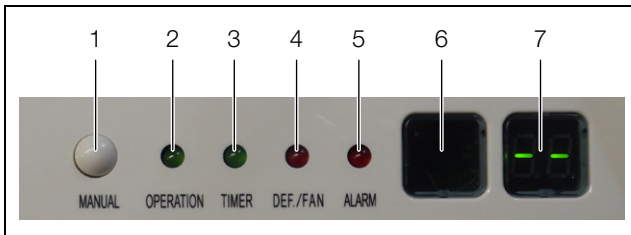

Fig. 19: Control and display device 3

Key

- 1 Manual (to request operating statuses)
- 2 Operation (permanently illuminated during operation, flashes when the system is being booted up)
- 3 Timer (no function)
- 4 DEF/FAN (no function)
- 5 External unit alarm
- 6 No function
- 7 LCD display (displays a fault code in case of an alarm)

7.2 Switching the LCU DX on and off

7.2.1 Switching on the internal and external units

Once both the internal unit and the external unit are electrically connected, carry out the following two steps:

- Switch on the on-site power supply to the external unit.
The internal unit is supplied with power via the external unit.
- Switch on the LCU DX on control and display device 1 using the "ON/OFF button".

7.2.2 Switching off the internal and external units

To switch off the LCU DX and the condenser, proceed as follows:

- Switch off the LCU DX on control and display device 1 using the "ON/OFF button".
- Switch off the on-site power supply to the external unit.

7.2.3 Switching off in an emergency

To switch off the LCU DX in an emergency, proceed as follows:

- Switch off the on-site power supply to the external unit.

7.3 Setting the setpoint temperature

The setpoint temperature (outlet temperature of the internal unit or server air intake temperature) is set on control and display devices 1 and 2 using the arrow keys. It is essential that both values are set identically.

Observe the manufacturer's information on temperature settings for the components built into the server enclosure. We recommend a setting within the range 22 °C–25 °C. Because the LCU DX cannot actively regulate hu-

midity, where necessary the set temperature should be adjusted in line with the ambient conditions.

- First set the required setpoint temperature on control and display device 1.
- For the "redundant" version, also set the same setpoint temperature on control and display device 2.
- On control and display device 2, keep the Set button held down for 3 seconds.
Your setting is displayed.
- Using the arrow keys, set the same setting as previously set on control and display device 1.
- Confirm this value by pressing the Set button again.
The setpoint is displayed on control and display unit 2.
- As a general rule, the setpoints on all control components should be set to the same value.

8 Troubleshooting

8.1 General

If there is a malfunction or alarm on the device, a corresponding error message will be displayed on control and display device 3 and the alarm relay will switch (collective fault signal). The corresponding fault code may be read from the 2-digit LCD display.



Note:

For technical queries, or if servicing is required, please contact Rittal using the addresses shown in section 15 "Customer service addresses".

8.2 List of error messages

8.2.1 Control and display device 3

The following error messages can be read from control and display device 3 (on the face of the internal unit).

Malfunction code in display	Description of malfunction
E1	Communication malfunction between internal and external unit
E2	Temperature sensor for server air intake (sensor 1) defective or missing
E4	Register temperature sensors T2 (sensor 5), T2B (sensor 6) or T2C (sensor 7) defective or missing
E7	EEPROM defective
Ed	Error in external unit*

* Error code must be read by a service technician on the external unit.

8.2.2 Control and display device 2

The following error message can be read from control and display device 2 (Dixell controller).

Malfunction code in display	Description of malfunction
P1	Temperature sensor error (sensor 3)

9 Inspection and maintenance

The following maintenance work should be carried out on the LCU DX:

- The condensate discharge device should be checked regularly for correct functioning.
- Regularly check the refrigerant circuit and all main components for correct functioning (at least once a year according to DIN EN 378).
- Regularly check for leaks using a suitable device (annually) as required by the F-gas regulation (see section 2.3.3 "F-gas regulation" and section 2.3.4 "Chemicals – Climate Protection Ordinance").



Note:

At an ambient temperature of 40 °C, the nominal service life of the built-in fan is 40,000 operating hours.

10 Storage and disposal

EN

10 Storage and disposal



Caution! Risk of damage!

The LCU DX must not be subjected to temperatures above +50 °C during storage.

During storage, both the internal as well as the external unit must stand upright.

Disposal can be performed at the Rittal plant.

Please contact us for advice.



Caution! Risk of environmental contamination!

Never allow refrigerant from the cooling circuit or oil from the compressor to escape into the environment.

Refrigerant and oil must be properly disposed of in accordance with the valid national legislation and regulations.

11 Technical specifications

11.1 LCU DX 3 kW

Technical specifications	Internal unit	External unit
Description/Model No.	3311490: LCU DX 3 kW "single" version	
Description/Model No.	3311491: LCU DX 3 kW "redundant" version	
Dimensions and weight		
Dimensions (width x height x depth) [mm]	105 x 1550 x 820	800 x 554 x 333
Weight, max. [kg]	48	38
Electrical connection		
Type of electrical connection	Connection clamp	
Rated voltage [V, Hz]	1~/N/PE 230, 50	
Rated current [A]	7	
Start-up current [A]	4.9	
Pre-fuse T [A]	–	16
Max. power consumption [kW]	1.6	
Duty cycle [%]	100	100
Cooling output		
Nominal cooling output [kW]	L22* L35 3.5 (* server inlet air temperature)	
Power consumption at nominal cooling output [kW]	L22* L35 1.35 (* server inlet air temperature)	
Energy Efficiency Ratio (EER) L22 L35	2.6	
Air throughput, max. [m ³ /h]	2,500	
Cooling circuit		
Refrigerant / filled weight [kg]	R410A/1.78 (Fluid Group 2)	
Additional refrigerant from the 5th metre [g/m]	15 (max. fill volume: 2155 g)	
Max. permissible pressure [bar]	PS HP: 42	
	PS LP: 28	
Pipe cross-section, intake gas line	1/2"	
Pipe cross-section, liquid line	1/4"	
Compressor oil		VG 74
Other information		
Storage temperatures [°C]	-20...+50	
Temperature range [°C]	+15...+35	-20...+45
IP protection category IEC 60529	IP 20	IP X4
Noise level [dB (A)]	65 (distance 1 m)	40 (Open air above reflective flooring, distance 10 m)
Colour	RAL 7035	White

Tab. 6: Technical specifications for the LCU DX 3 kW

11 Technical specifications

EN

11.2 LCU DX 6.5kW

Technical specifications	Internal unit	External unit
Description/Model No.	3311492: LCU DX 6.5 kW "single" version	
Description/Model No.	3311493: LCU DX 6.5 kW "redundant" version	
Dimensions and weight		
Dimensions (width x height x depth) [mm]	105 x 1550 x 820	845 x 702 x 363
Weight, max. [kg]	48	48
Electrical connection		
Type of electrical connection	Connection clamp	
Rated voltage [V, Hz]	1~/N/PE 230, 50	
Rated current [A]	15.9	
Start-up current [A]	5.4	
Pre-fuse T [A]	–	20
Max. power consumption [kW]	3.6	
Duty cycle [%]	100	100
Cooling output		
Nominal cooling output [kW]	L22* L35 6.2 kW (* server inlet air temperature)	
Power consumption at nominal cooling output [kW]	L22* L35 3.14 kW (* server inlet air temperature)	
Energy Efficiency Ratio (EER) L22 L35	1.97	
Air throughput, max. [m ³ /h]	4,800	
Cooling circuit		
Refrigerant / filled weight [kg]	R410A/1.95 (Fluid Group 2)	
Additional refrigerant from the 5th metre [g/m]	30 (max. fill volume: 3300 g)	
Max. permissible pressure [bar]	PS HP: 42	
	PS LP: 28	
Pipe cross-section, intake gas line	5/8"	
Pipe cross-section, liquid line	3/8"	
Compressor oil	VG 74	
Other information		
Storage temperatures [°C]	-20...+50	
Temperature range [°C]	+15...+35	-20...+45
IP protection category IEC 60529	IP 20	IP X4
Noise level [dB (A)]	66 (distance 1 m)	40 (Open air above reflective flooring, distance 10 m)
Colour	RAL 7035	White

Tab. 7: Technical specifications for the LCU DX 6.5 kW

11.3 Information about the refrigerant



Caution!

The LCU DX may only be operated with refrigerant R410A. Use of any other refrigerant will invalidate the guarantee.



Caution! Risk of malfunction or damage! Installation, and in particular laying of the refrigerant pipework between the internal and external unit of the LCU DX, must only be carried out by trained, qualified and accredited cooling system specialists.

To avoid damage to the device, Rittal prescribes the use of refrigerant R410A.

R410A is virtually azeotropic and is comprised of equal parts of R32 and R125. The basic properties of R410A are:

- No ozone depletion potential
- Clear
- Liquefied gas smelling of ether
- Non-combustible
- Low toxicity

Property	Value
Composition	50%: R32 (CH ₂ F ₂) 50%: R125 (C ₂ HF ₅)
Molar mass [g/mol]	72.585
Boiling point [°C]	-52.7
Vapour pressure [bar]	12.46 at 15 °C
Relative density	1.11 at 15 °C

Tab. 8: Material data for R410A



Note:

Safety data sheets are available for downloading at www.rittal.com.

11.4 Cooling output

Due to the device configuration comprising two sub-units, and the partially linear operation of the components (fan, inverter-controlled cooling unit), the cooling output of the device is dependent on various factors:

- External temperature at the installation site of the external unit
- Thermal output from the server enclosure
- Inlet temperature of hot air into the internal unit
- Settings
- Position of the sensor on the front of the server

Due to the control response, the temperature directly at the air outlet of the internal unit may fluctuate between -3 K and +4 K. A fluctuation period lasts one to two minutes. On average, the temperatures at the air outlet of the internal unit are within the tolerance of ±2 K.

11 Technical specifications

EN

11.4.1 LCU DX 3 kW

Exterior temperature [°C]	-18					
Setpoint [°C] ± 2 K	22		25		28	
Cooling output [kW] min./max.	1.00	3.00	1.00	3.00	1.00	3.00
Power consumption [kW]	0.41	0.64	0.46	0.65	0.45	0.68

Tab. 9: Exterior temperature -18 °C

Exterior temperature [°C]	-5					
Setpoint [°C] ± 2 K	22		25		28	
Cooling output [kW] min./max.	1.00	3.00	1.00	3.20	1.00	3.50
Power consumption [kW]	0.46	0.57	0.46	0.66	0.46	0.68

Tab. 10: Exterior temperature -5 °C

Exterior temperature [°C]	10					
Setpoint [°C] ± 2 K	22		25		28	
Cooling output [kW] min./max.	1.00	3.50	1.00	3.50	1.00	3.50
Power consumption [kW]	0.43	0.62	0.45	0.69	0.48	0.68

Tab. 11: Exterior temperature 10 °C

Exterior temperature [°C]	20					
Setpoint [°C] ± 2 K	22		25		28	
Cooling output [kW] min./max.	1.00	3.50	1.00	3.50	1.00	3.50
Power consumption [kW]	0.49	0.99	0.46	1.05	0.49	0.68

Tab. 12: Exterior temperature 20 °C

Exterior temperature [°C]	35					
Setpoint [°C] ± 2 K	22		25		28	
Cooling output [kW] min./max.	1.00	3.50	1.00	3.50	1.00	3.50
Power consumption [kW]	1.00	1.35	0.62	1.43	0.62	0.68

Tab. 13: Exterior temperature 35 °C

Exterior temperature [°C]	44					
Setpoint [°C] ± 2 K	22		25		28	
Cooling output [kW] min./max.	1.00	3.50	1.00	3.50	1.00	3.50
Power consumption [kW]	1.02	1.45	0.97	1.52	0.97	0.68

Tab. 14: Exterior temperature 44 °C

11.4.2 LCU DX 6.5 kW

Exterior temperature [°C]	-18					
Setpoint [°C] ± 2 K	22		25		28	
Cooling output [kW] min./max.	3.00	6.50	3.00	6.50	3.00	6.50
Power consumption [kW]	1.45	2.03	1.66	2.10	1.52	2.10

Tab. 15: Exterior temperature -18 °C

Exterior temperature [°C]	-5					
Setpoint [°C] ± 2 K	22		25		28	
Cooling output [kW] min./max.	3.00	6.50	3.00	6.50	3.00	6.50
Power consumption [kW]	1.65	2.10	1.48	2.10	1.60	2.10

Tab. 16: Exterior temperature -5 °C

Exterior temperature [°C]	10					
Setpoint [°C] ± 2 K	22		25		28	
Cooling output [kW] min./max.	3.00	6.50	3.00	6.50	3.00	6.50
Power consumption [kW]	1.57	2.06	1.53	2.18	1.66	2.18

Tab. 17: Exterior temperature 10 °C

Exterior temperature [°C]	20					
Setpoint [°C] ± 2 K	22		25		28	
Cooling output [kW] min./max.	3.00	6.50	3.00	6.50	3.00	6.50
Power consumption [kW]	1.80	2.63	1.86	2.67	1.89	2.67

Tab. 18: Exterior temperature 20 °C

Exterior temperature [°C]	35					
Setpoint [°C] ± 2 K	22		25		28	
Cooling output [kW] min./max.	3.00	6.20	3.00	6.50	3.00	6.50
Power consumption [kW]	2.18	3.14	2.27	3.20	2.27	3.12

Tab. 19: Exterior temperature 35 °C

Exterior temperature [°C]	44					
Setpoint [°C] ± 2 K	22		25		28	
Cooling output [kW] min./max.	3.00	4.00	3.00	4.00	3.00	5.00
Power consumption [kW]	1.66	1.80	1.72	1.96	1.80	2.25

Tab. 20: Exterior temperature 44 °C

11 Technical specifications

EN

11.5 Overview drawings

11.5.1 Internal unit LCU DX 3 kW and 6.5 kW

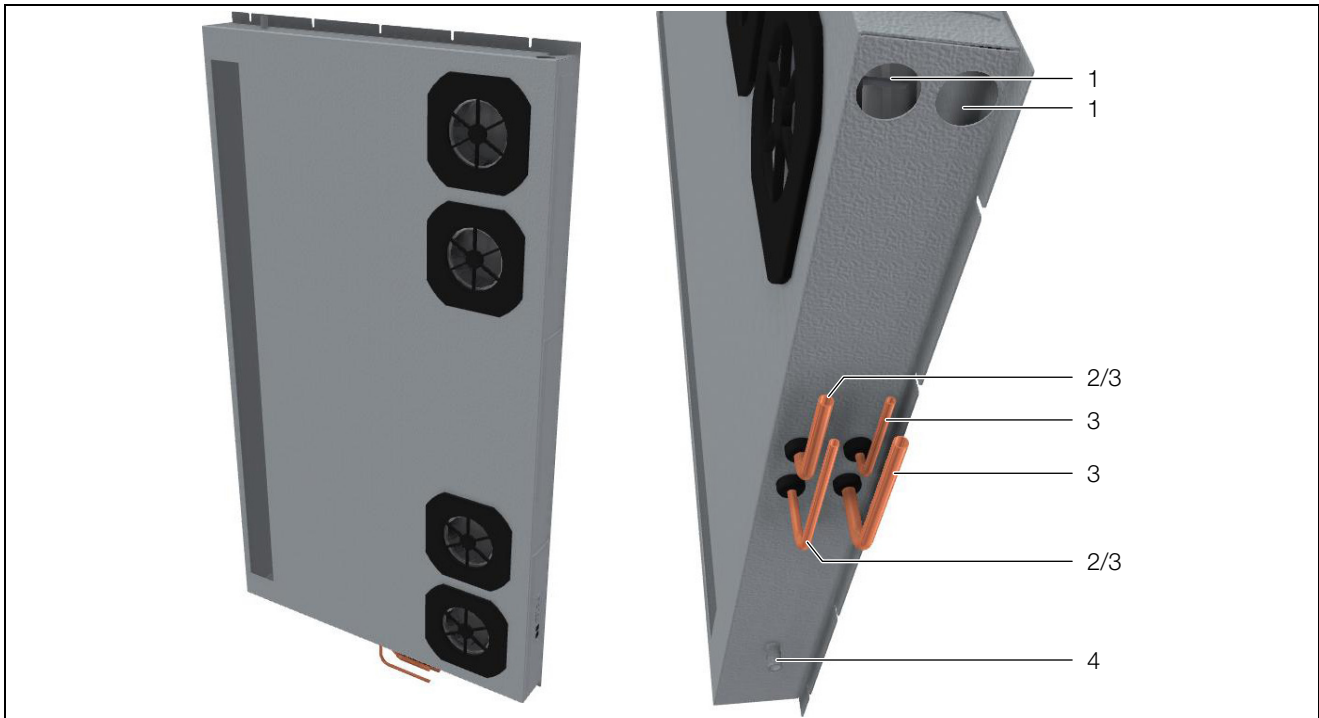

Fig. 20: Overview drawing of internal unit LCU DX 3 kW and 6.5 kW ("redundant" version)

Key

- 1 Insert for data and supply cables
- 2 Refrigerant line for "single" version (1 pair)
- 3 Refrigerant line for "redundant" version (2 pairs)
- 4 Condensate discharge

11.5.2 Dimensions of internal unit LCU DX 3 kW and 6.5 kW

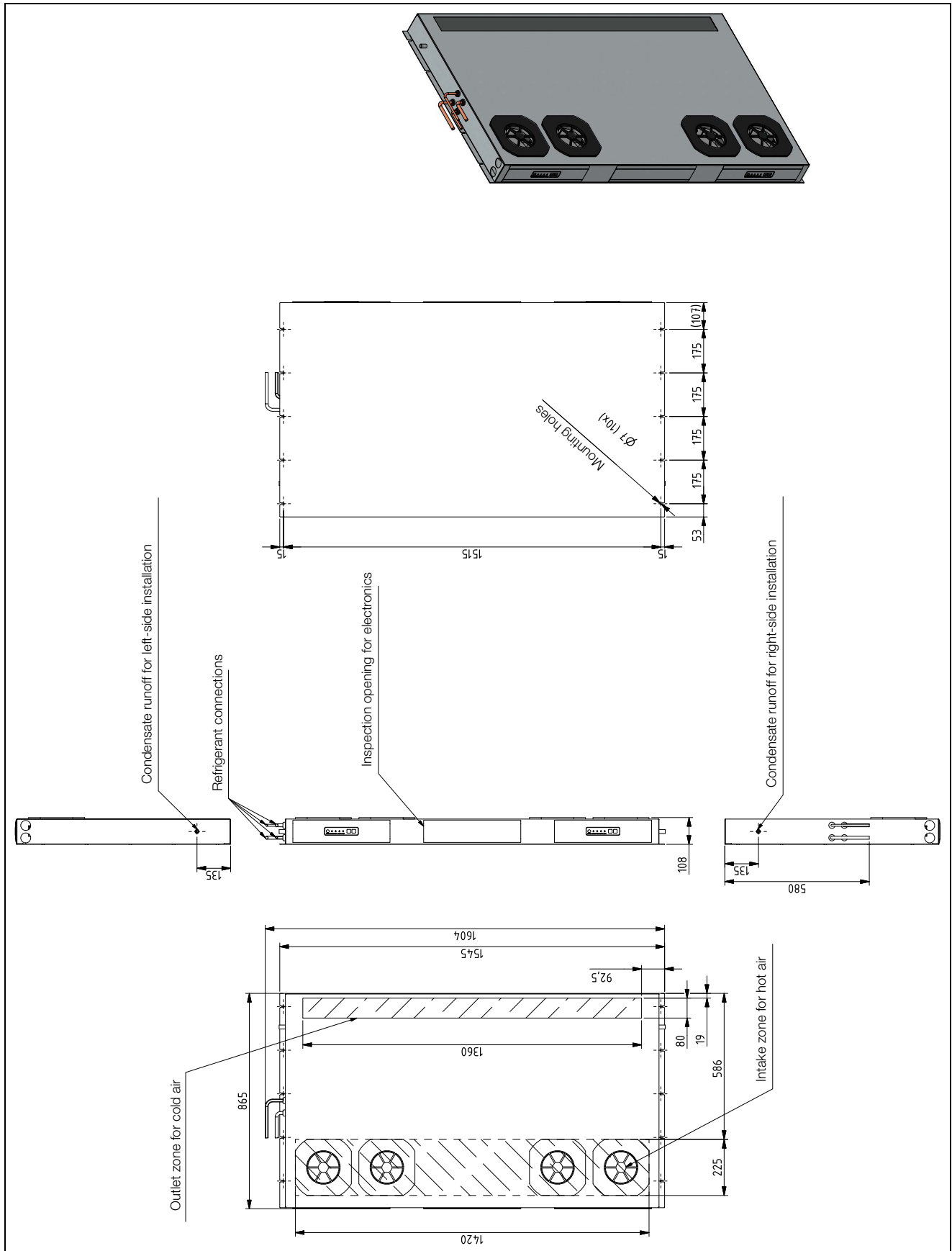

Fig. 21: Dimensions of internal unit LCU DX 3 kW and 6.5 kW

11 Technical specifications

EN

11.6 RI flow chart LCU DX

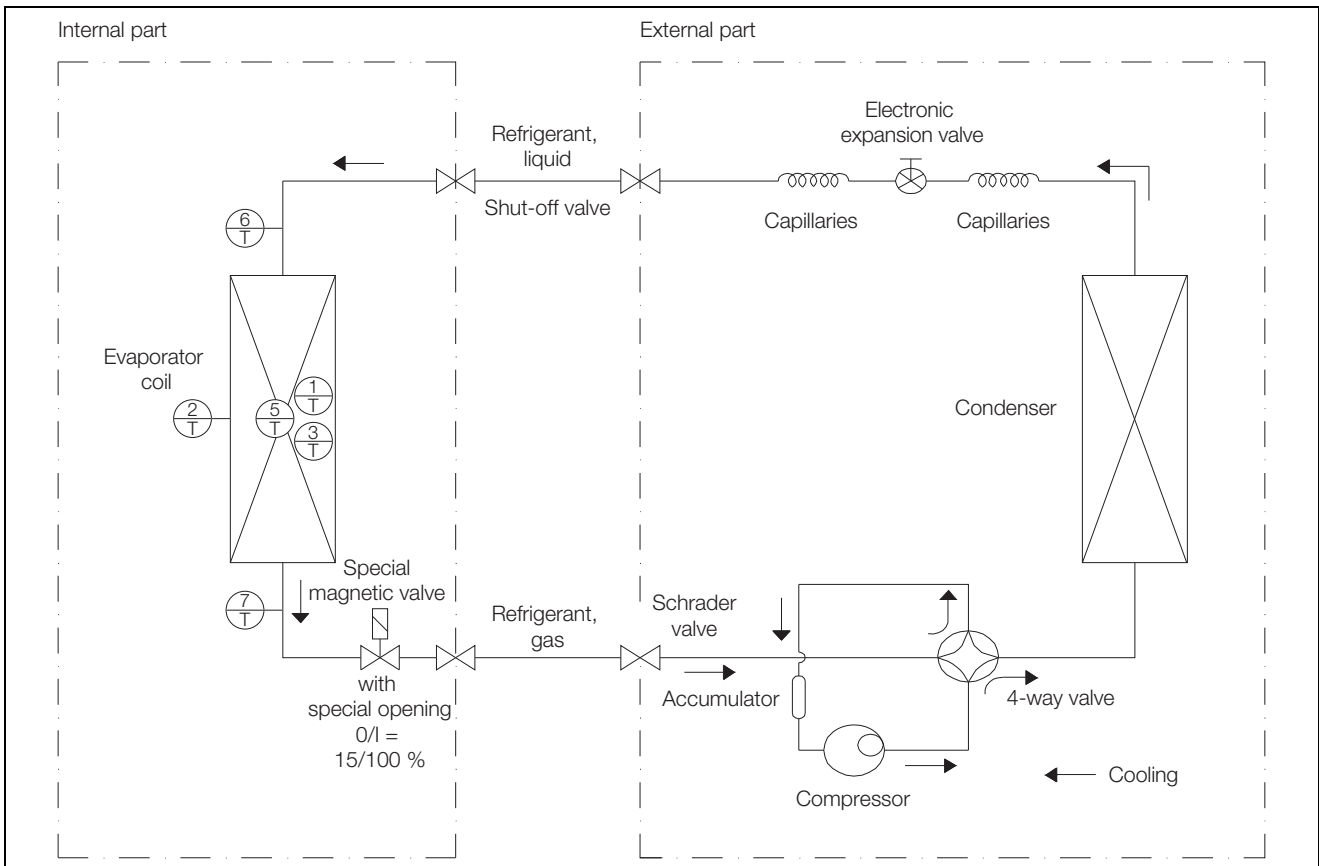

Fig. 22: RI flow chart

11.7 Circuit diagram

11.7.1 Functional diagram, internal unit

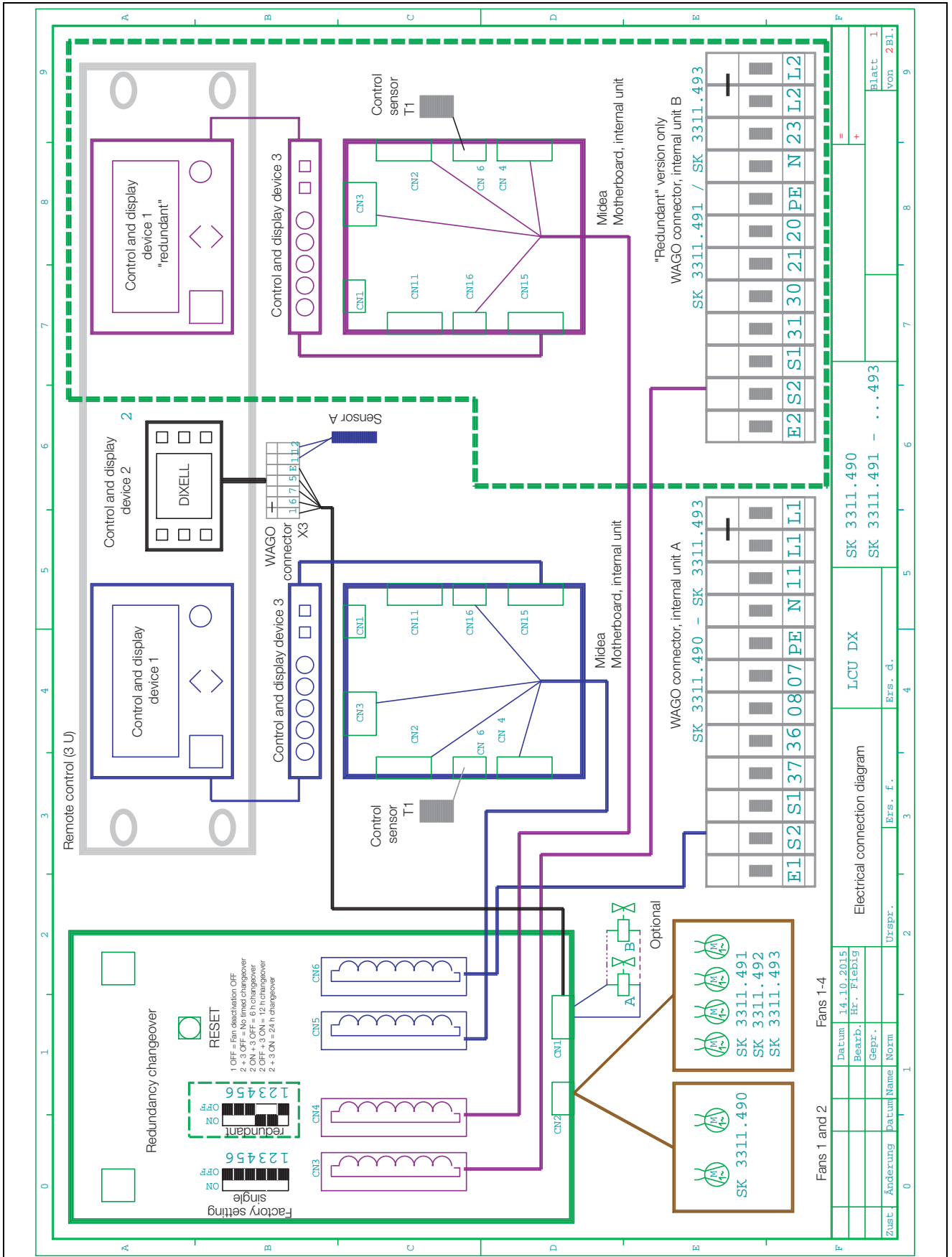

Fig. 23: Functional diagram, internal unit

11.7.3 Circuit diagram, external unit SK 3311.490 and SK 3311.491

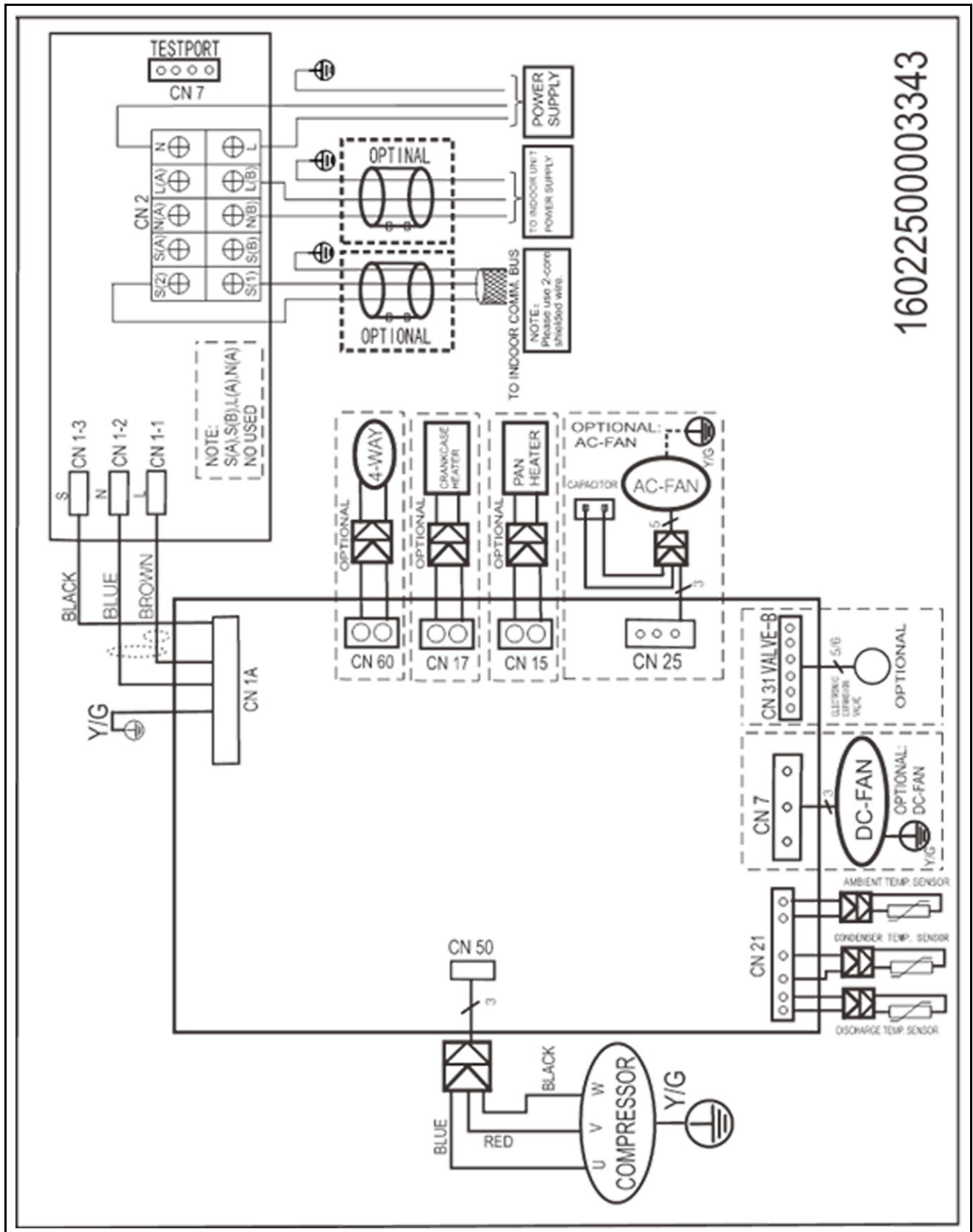

Fig. 25: Circuit diagram, external unit SK 3311.490 and SK 3311.491

11 Technical specifications

11.7.4 Circuit diagram, external unit SK 3311.492 and SK 3311.493

EN

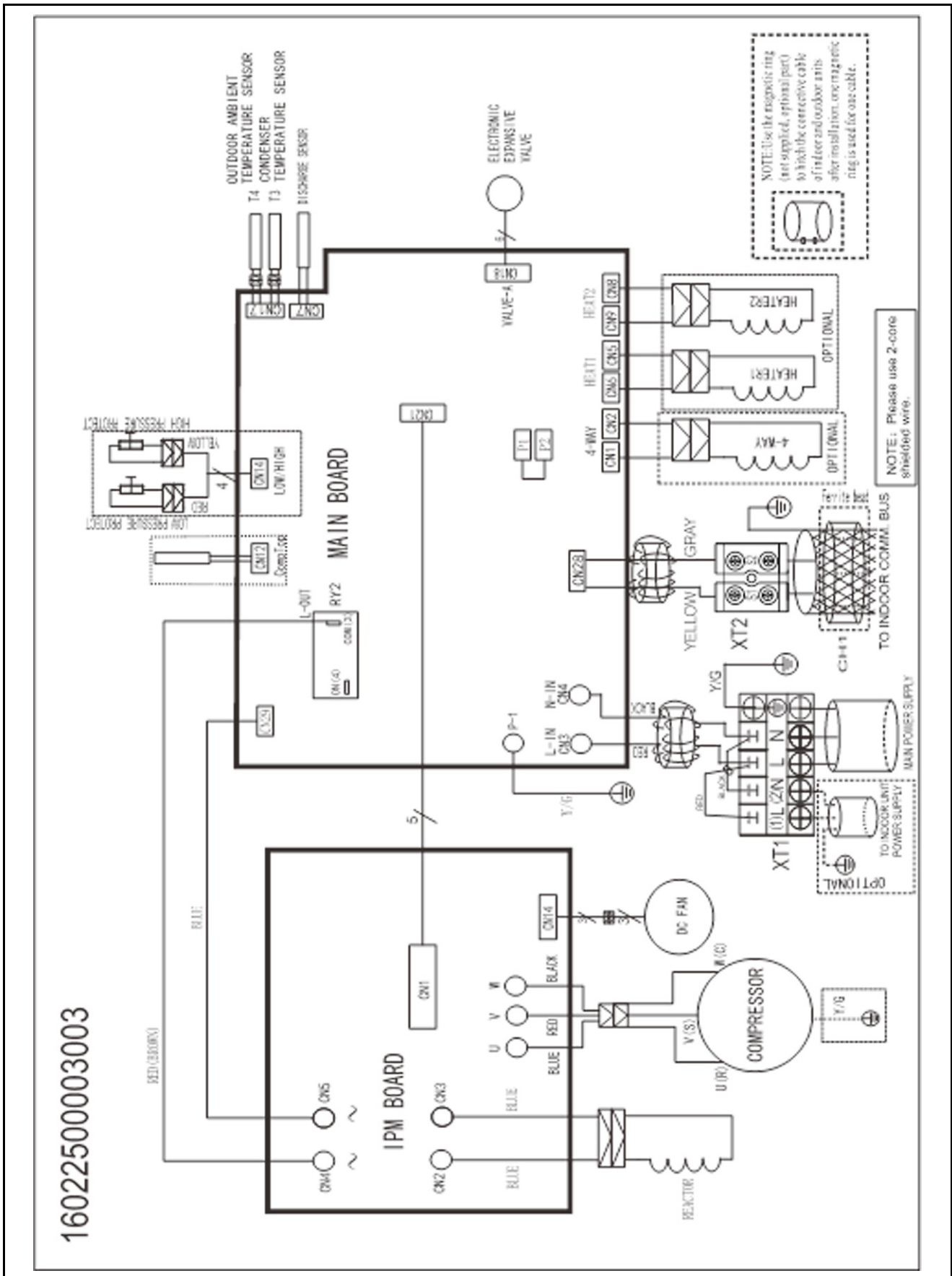

Fig. 26: Circuit diagram, external unit SK 3311.492 and SK 3311.493

11.8 Functional description of sensors

On the following page you will find an overview diagram showing the sensor positions (fig. 27).

11.8.1 HaRed sensor (sensor 1)

The HaRed sensor measures the temperature at the air outlet of the LCU DX internal unit.

In redundantly designed LCU DX units (3311.490 and 3311.493), in the event of an overtemperature, the sensor activates the unit in stand-by mode (see section 3.3 "Fault and operating hours changeover": Activate the stand-by unit at >28 °C).

11.8.2 EBM sensor to control the fan speed (sensor 2)

The EBM sensor is positioned in the internal unit of the LCU DX between the evaporator coil and the electrical connection compartment.

With a 2–10 V control signal, the sensor regulates the speed of all available EBM EC fans in the internal unit.

11.8.3 Temperature sensor in the Dixell controller (sensor 3)

The temperature sensor on control and display device 2 (Dixell controller) is positioned inside the evaporator coil on the outlet grille, and measures the evaporator coil outlet air temperature and the server inlet air temperature.

The Dixell controller regulates the start-up response following a power failure or if the minimum cooling load is undercut.

It controls the magnetic valve (see section 11.6 "RI flow chart LCU DX"). If the evaporator coil outlet temperature drops 0.1 °C below the set value, the magnetic valve will be closed. The refrigerant in the pipeline is extracted, and in the evaporator coil of the internal LCU DX unit, evaporation ceases after a short time. The evaporator coil package is heated by the server outlet air. As soon as the temperature of the evaporator coil outlet air exceeds the setpoint, the Dixell controller will open the magnetic valve again. This process limits the lowest temperature of the air expelled from the LCU DX. At an outlet temperature of ≤ 2 K below the setpoint, the compressor will shut out.

11.8.4 Temperature sensor T1 (sensor 4)

Temperature sensor T1 is positioned outside of the internal LCU DX unit in the server rack.

The recommended position is opposite the outlet opening of the internal LCU DX unit in the cooling zone, at mid-height (fig. 6).

It can be fastened to the 482.6 mm (19") mounting angle or to the frame of the TS IT server enclosure.

This sensor is responsible for controlling the server inlet air temperature.

11.8.5 Temperature sensors T2-T2C (sensors 5, 6 and 7)

Temperature sensors T2-T2C are control sensors that allow the internal board to regulate the cooling output.

12 Spare parts

Item	Qty. / Packs of
Evaporator coil control board	1
Display	1
Compressor	1
Inverter motherboard	1
Electronic expansion valve	1
Evaporator coil fan	1
Dixell (evaporator coil)	1
Temperature sensor hot/cold air	1
Refrigerant filter	2

Tab. 21: List of spare parts – LCU DX

13 Accessories

EN

13 Accessories

Item	Model No.	Qty. / Packs of	Remarks
Refrigerant pipe kit		1	
Refrigerant pipe kit 20 m, insulated, for LCU DX 3 kW	3311.495	1	
Refrigerant pipe kit 20 m, insulated, for LCU DX 6.5 kW	3311.496	1	

Tab. 22: List of accessories – LCU DX

14 Glossary

1 U server:

1 U servers are very flat and deep, modern high performance servers, whose height corresponds to one height unit (1 U = 44.54 mm, the smallest standard height division). Typical dimensions are (W x D x H) 482.6 mm (19") x 800 mm x 1 U.

These systems normally include 2 CPUs, many GB RAM and hard drives, so that they require up to 100 m³/h cooling air at a maximum of 32 °C.

482.6 mm (19") level:

The front sides of the devices built into the server enclosure form the 482.6 mm (19") level.

Blade server:

By orienting dual CPU systems vertically and placing up to 14 units on a common backplane to provide for signal routing and power supply, a blade server is created.

Blade servers can "generate" up to 4.5 kW heat loss per 7 U and 700 mm depth.

"Front to back" cooling principle:

The devices built into the server enclosure are normally cooled according to the "front to back" cooling principle.

Under this cooling principle, cold air supplied by external air conditioning is blown to the front of the server enclosure. The fans in the devices built into the server enclosure direct this air horizontally through the server enclosure. The air is warmed through this process and is exhausted out of the rear of the enclosure.

Hot spot:

A hot spot is the concentration of thermal energy in a small area.

Hot spots normally lead to local overheating and can cause system malfunctions.

Switch:

Multiple servers normally communicate with one another and in the network using switches.

Because as many inputs as possible are located on the front side of switches, they frequently have an airflow from the side, not "front to back" cooling.

15 Customer service addresses

EN

15 Customer service addresses

For technical queries, please contact:

Tel.: +49(0)2772 505-9052

E-mail: info@rittal.de

Homepage: www.rittal.com

For complaints or service requests, please contact:

Tel.: +49(0)2772 505-1855

E-mail: service@rittal.de

Rittal GmbH & Co. KG

Auf dem Stützelberg

35745 Herborn

Germany

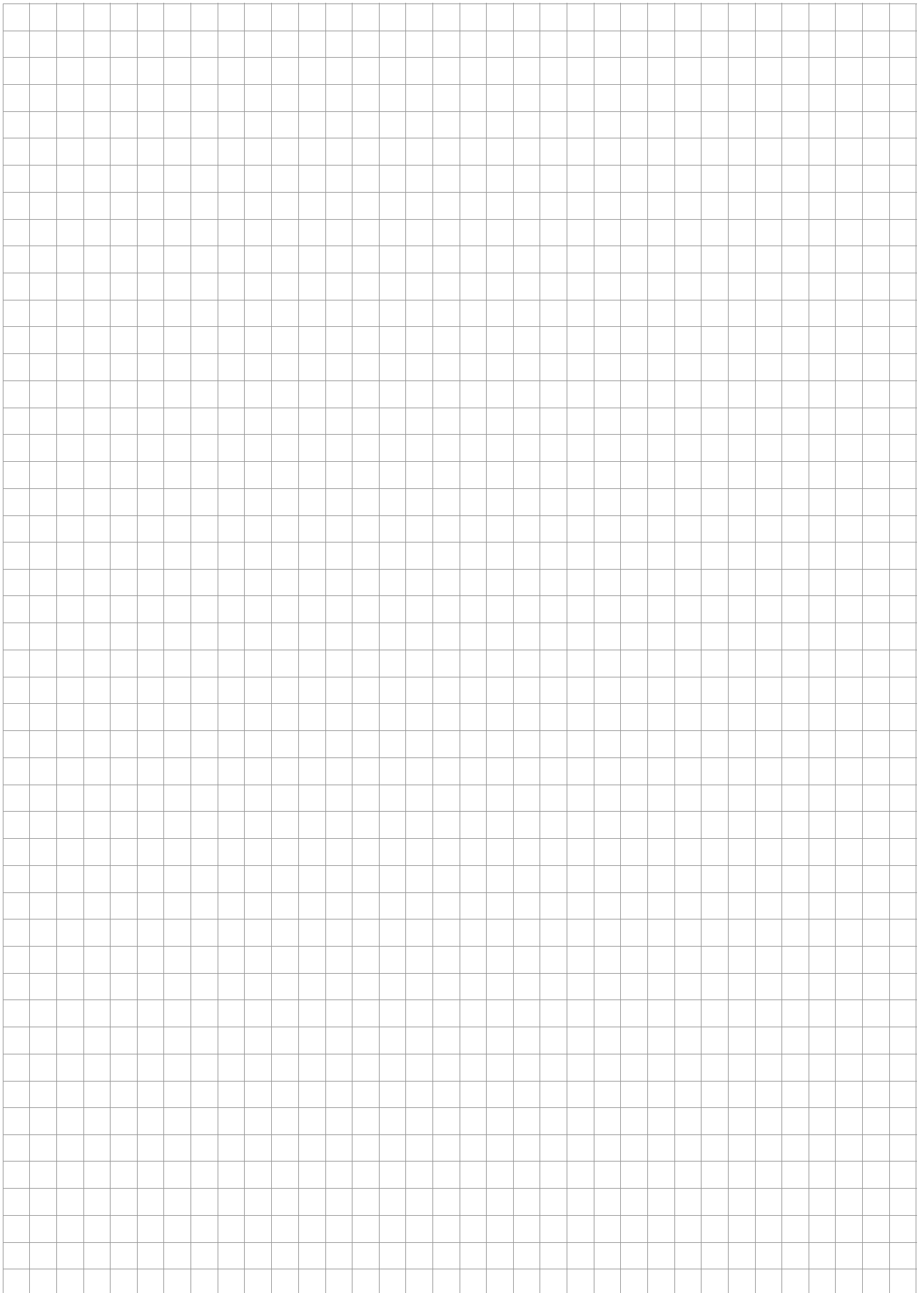

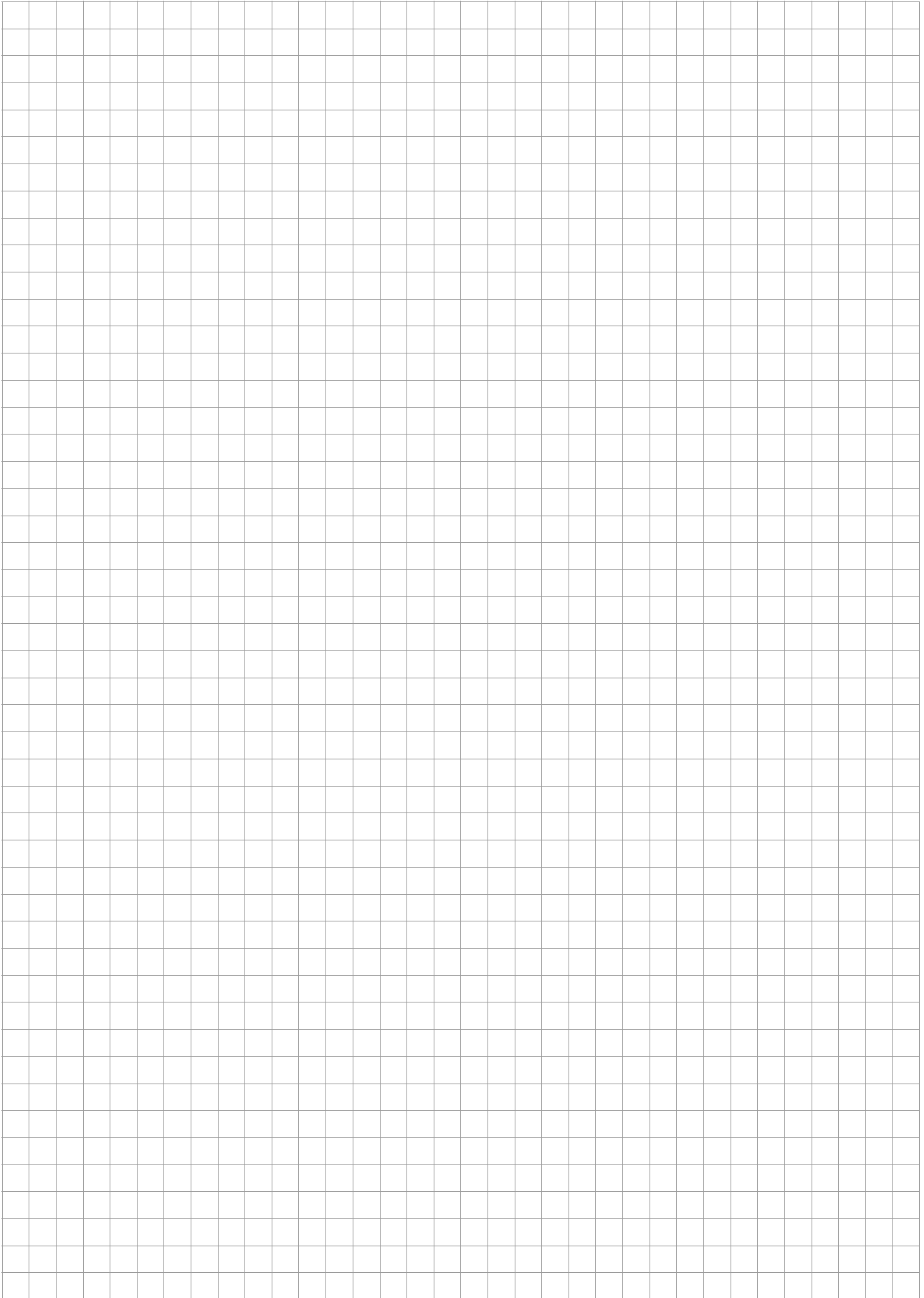

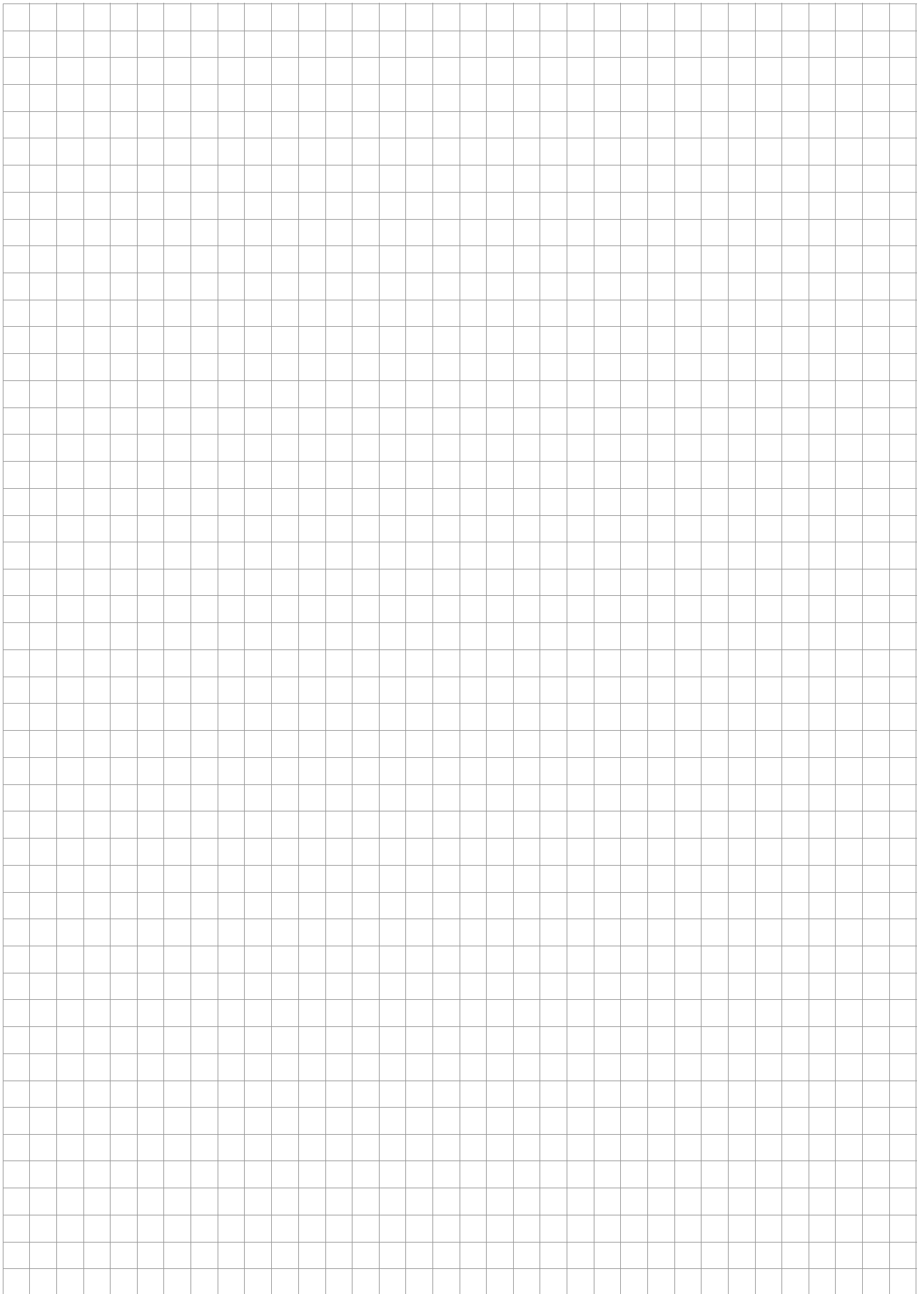

Rittal – The System.

Faster – better – everywhere.

- Enclosures
- Power Distribution
- Climate Control
- IT Infrastructure
- Software & Services

You can find the contact details of all Rittal companies throughout the world here.



www.rittal.com/contact

RITTAL GmbH & Co. KG
Auf dem Stuetzelberg · 35745 Herborn · Germany
Phone +49 2772 505-0
E-mail: info@rittal.de · www.rittal.com

01.2020

ENCLOSURES

POWER DISTRIBUTION

CLIMATE CONTROL

IT INFRASTRUCTURE

SOFTWARE & SERVICES

FRIEDHELM LOH GROUP

