

Enclosures

Enclosure systems

Baying enclosure system VX25

Distribution enclosure

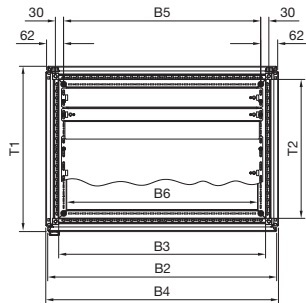
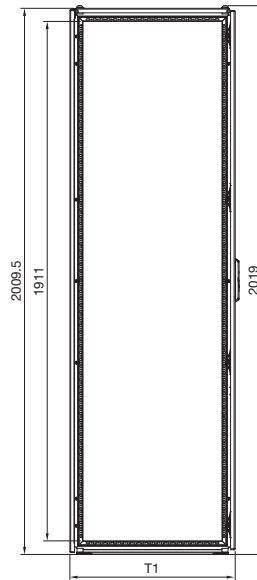
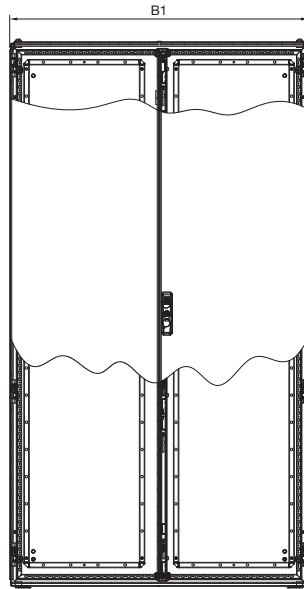
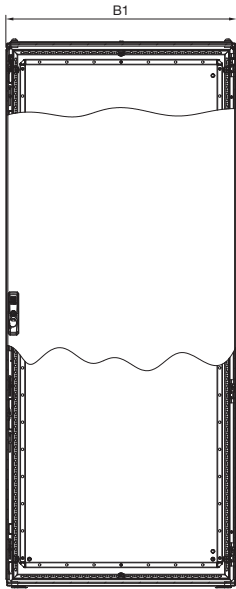

Profile

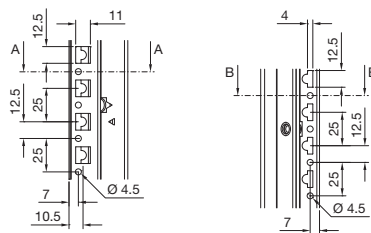

Section A - A

Section B - B

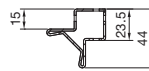
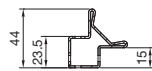

- B1 = Overall width
- B2 = Width of rear panel
- B3 = Clearance of enclosure frame
- B4 = Width with side panels
- B5 = Hole distance, base/plinth attachment
- B6 = Clearance opening, base
- T1 = Overall depth with rear and side panel
- T2 = Clearance of enclosure frame

Model No.	Width dimensions mm						Depth dimensions mm	
	B1	B2	B3	B4	B5	B6	T1	T2
9666.916	849	842	761	856	725	702	608	511
9666.926	1099	1092	1011	1106	975	952	608	511
9666.956	849	842	761	856	725	702	408	311
9666.966	1099	1092	1011	1106	975	952	408	311