

# Skabe

## Skabssystemer

### Rækkeskabssystem VX25

Fordelingstavler

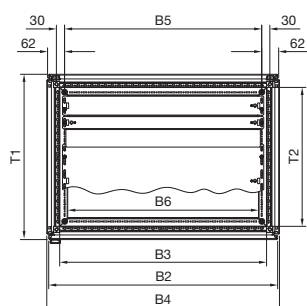
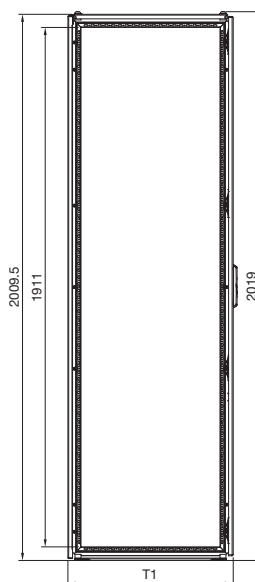
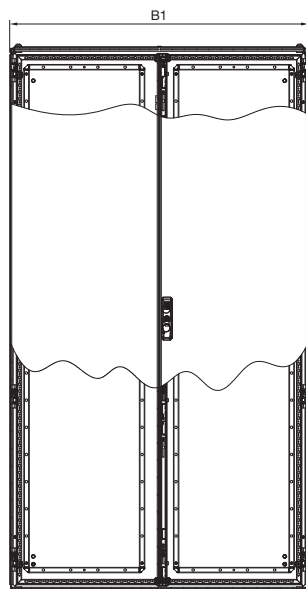
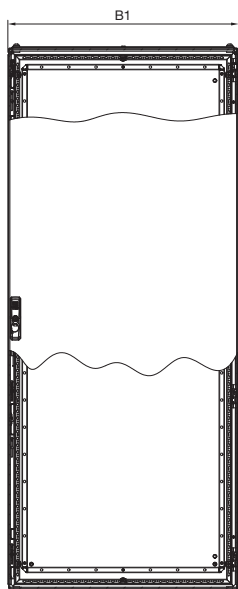

Profil

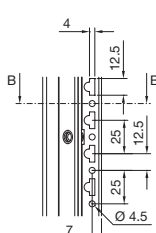
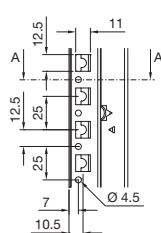

Sektion A - A

Sektion B - B

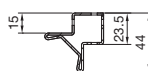
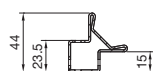

- B1= Totalbredde
- B2= Bredde af bagplade
- B3= Indvendig frihøjde for ramme
- B4= Bredde af sideplader
- B5= Hulafstand bund-/sokkelmontage
- B6= Indvendig frihøjde for åbning i bund
- T1= Totaldybde med bag- og sideplade
- T2= Indvendig frihøjde for ramme

Produkt nr.	Breddemål mm						Dybdemål mm	
	B1	B2	B3	B4	B5	B6	T1	T2
9666.916	849	842	761	856	725	702	608	511
9666.926	1099	1092	1011	1106	975	952	608	511
9666.956	849	842	761	856	725	702	408	311
9666.966	1099	1092	1011	1106	975	952	408	311