

# Armarios de distribución

## Sistemas de armarios

### Sistema de armarios ensamblables VX25

Armario para distribución

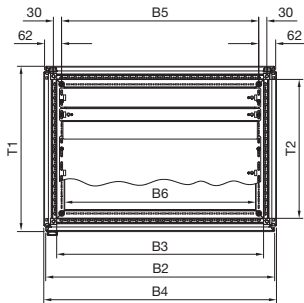
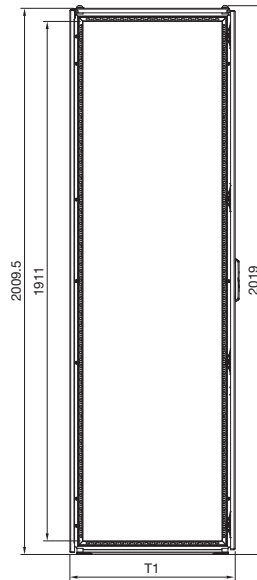
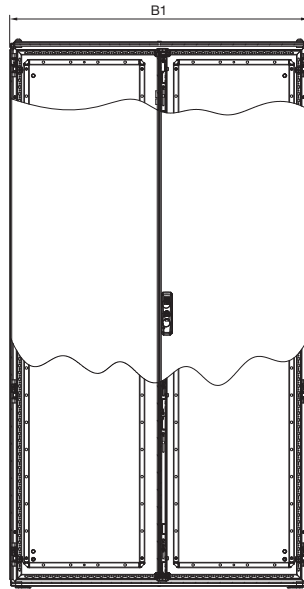
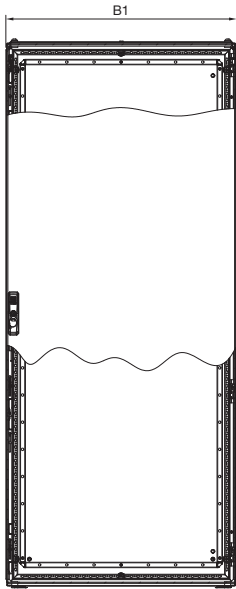

Perfil

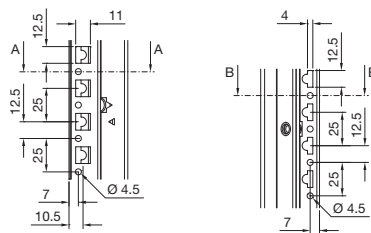

Sección A - A

Sección B - B

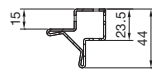
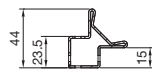

- B1 = Anchura total
- B2 = Anchura del dorsal
- B3 = Medida interior bastidor
- B4 = Anchura con laterales
- B5 = Distancia perforación de fijación suelo/zócalo
- B6 = Medida interior de la abertura del suelo
- T1 = Profundidad total con dorsal y lateral
- T2 = Medida interior bastidor

Referencia	Medidas de anchura mm						Medidas de profundidad mm	
	B1	B2	B3	B4	B5	B6	T1	T2
9666.916	849	842	761	856	725	702	608	511
9666.926	1099	1092	1011	1106	975	952	608	511
9666.956	849	842	761	856	725	702	408	311
9666.966	1099	1092	1011	1106	975	952	408	311