

# Kytkäkaapit

## Kaappijärjestelmät

### Rivikaappijärjestelmä VX25

Jakokaapit

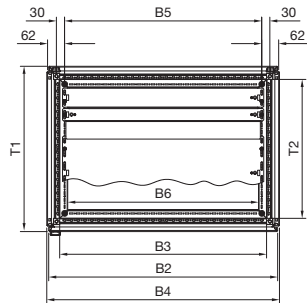
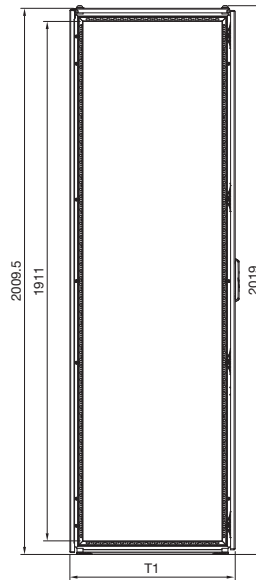
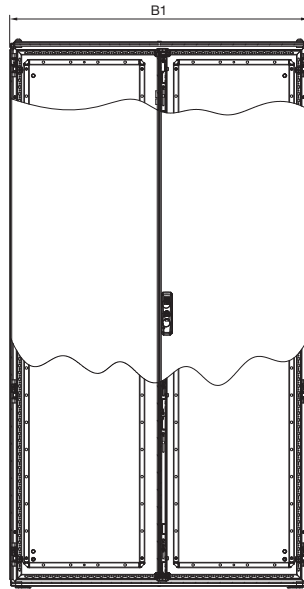
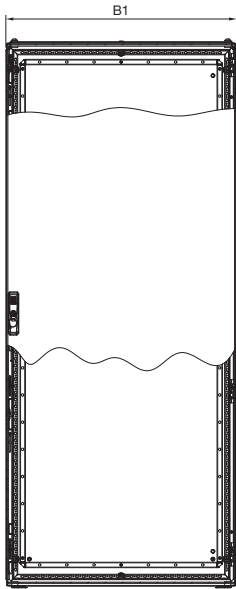

Profiili

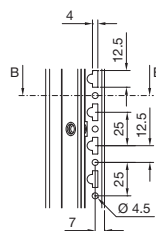
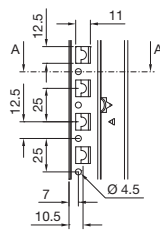

Leikkaus A - A

Leikkaus B - B

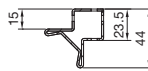
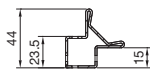

- B1 = kokonaisleveys
- B2 = takaseinän leveys
- B3 = rungon vapaa sisämitta
- B4 = leveys sivuseiniin
- B5 = lattia-/jalustakiinnityksen reikien väli
- B6 = lattia-aukon vapaa sisämitta
- T1 = kokonaissyvyys taka- ja sivuseiniin
- T2 = rungon vapaa sisämitta

Til.nro	Leveysmitta mm						Syvyysmitta mm	
	B1	B2	B3	B4	B5	B6	T1	T2
9666.916	849	842	761	856	725	702	608	511
9666.926	1099	1092	1011	1106	975	952	608	511
9666.956	849	842	761	856	725	702	408	311
9666.966	1099	1092	1011	1106	975	952	408	311