

Caixas e armários

Sistemas de armários

Sistema de armários modulares VX25

Armário para distribuição

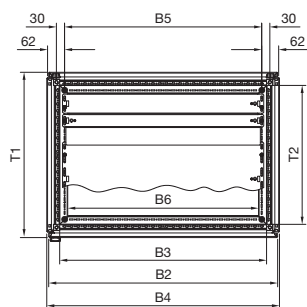
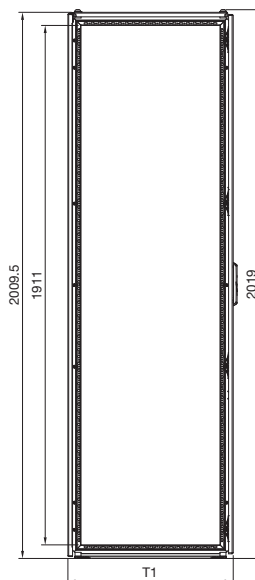
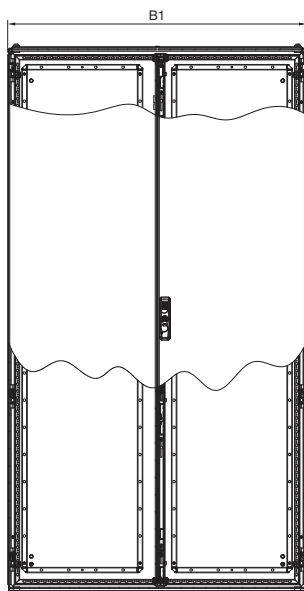
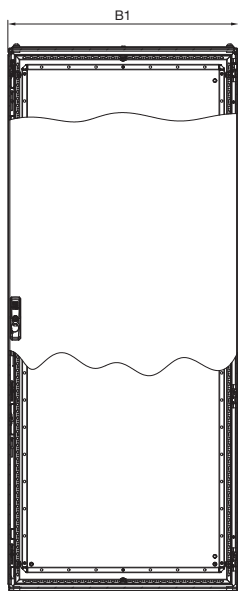

Perfil

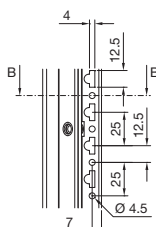
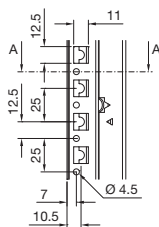

Corte A - A

Corte B - B

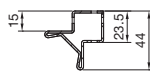
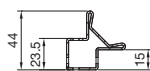

- B1 = Largura total
- B2 = Largura do painel traseiro
- B3 = Medida interna do quadro
- B4 = Largura com laterais
- B5 = Distância entre os furos para fixação da base na soleira
- B6 = Medida interna da abertura da base
- T1 = Profundidade total com painel traseiro e lateral
- T2 = Medida interna do quadro

Cód. Ref.	Medidas da largura mm						Medidas da profundidade mm	
	B1	B2	B3	B4	B5	B6	T1	T2
9666.916	849	842	761	856	725	702	608	511
9666.926	1099	1092	1011	1106	975	952	608	511
9666.956	849	842	761	856	725	702	408	311
9666.966	1099	1092	1011	1106	975	952	408	311