

Rittal – The System.

Faster – better – everywhere.



Crimping machine RC

AS 4050.456

Operating instructions

ENCLOSURES

POWER DISTRIBUTION

CLIMATE CONTROL

IT INFRASTRUCTURE

SOFTWARE & SERVICES

FRIEDHELM LOH GROUP



Contents

1	About this documentation.....	4
2	General safety notes.....	5
2.1	Intended use.....	5
2.2	Material that can be processed and crimping shape.....	5
2.3	Safety equipment.....	5
2.4	Personnel.....	6
3	Device description.....	7
3.1	Technical data.....	9
3.2	Type plate.....	10
4	Transporting and setting up the machine.....	11
4.1	Installation location.....	11
4.2	Transporting the machine.....	11
4.3	Unpacking the delivery.....	11
4.4	Scope of delivery.....	11
4.5	Establishing connections.....	12
5	Setting up the machine.....	12
5.1	Adjust reel holder.....	13
5.2	Inserting wire end ferrules.....	13
5.3	Changing the wire end ferrule reel.....	14
5.4	Setting the stripping length.....	15
5.5	Performing a stripping test.....	17
5.6	Setting the cutting depth.....	17
6	Operating the machine.....	18
6.1	Normal operation.....	18
6.2	Inserting the wire.....	18
6.3	Touch display and operating menus.....	18
6.4	Select cross section.....	19
6.5	Resetting the day's piece quantity.....	20
6.6	Changing operating mode.....	20
6.7	Displaying counters and processing times.....	20
6.8	Set language.....	21
6.9	Service display.....	21
6.10	Switching off the machine.....	21
7	Cleaning and maintaining the machine.....	22
7.1	Cleaning the machine externally.....	22
7.2	Machine maintenance.....	22
7.3	Maintenance schedule.....	22
7.4	Emptying waste container.....	24
7.5	Servicing the wire-holding tongs.....	24
7.6	Servicing the stranded wire fixing unit.....	25
7.7	Servicing the stripping unit.....	25
7.8	Servicing the crimping tool.....	26
7.9	Cleaning the interior.....	27
7.10	Servicing the tool slide.....	27
7.11	Servicing the transport unit.....	27
7.12	Servicing the compressed air maintenance unit.....	28
8	Troubleshooting.....	28
8.1	Fault table.....	29
8.2	Wearing parts.....	29
8.3	Replacing the stripping blade.....	29

8.4	Replacing fuses	31
9	Taking the machine out of operation and disposing of it	31
9.1	Taking the machine out of operation.....	31
9.2	Disposing of the machine.....	31

1 About this documentation

The warnings in this documentation are structured differently depending on the severity of danger.



Warning!

Possible risk of fatality!

Notices with the signal word "warning" warn you about situations which could lead to fatal or serious injuries if you do not pay attention to the notices specified.



Caution!

Risk of injury!







Notices with the signal word "caution" warn you about situations which could lead to injury if you do not pay attention to the notices specified.

Attention!

Property damage!

Notices with the signal word "attention" warn you about dangers which could result in damage to property.

Situation-related warnings may contain the following warning symbols:

Symbol	Meaning
	Warning: dangerous electrical voltage
	Warning: injury to hands due to sharp blades
	Warning: hand injuries (crushing)
	Work may only be performed by an electrical specialist
	Only perform work with personal protective equipment
	Notes on the documentation

Additional formatting is used in the rest of the text which has the following meaning:



Note:

This constitutes information which is not related to safety, but which provides important information regarding correct and effective work.

- This symbol indicates an "action point" and shows that you should perform an operation or procedure.

- Bullet points are indicated with dashes.

Operating instructions in other languages can be found on our website:



Click here!

2 General safety notes

2.1 Intended use

The machine is intended for the stripping and crimping of flexible wires in one work process.

Only the material described in section 2.2 may be processed using the machine. Process-safe processing can only be guaranteed for Rittal wire end ferrules. The processing of other makes may lead to faults and damage to the machine.

The machine must only be used within the technical limits described (see section 3.1 "Technical data" and 3.2 "Type plate"). Modifications to and reconstructions of the machine must not be performed. Notices may not be removed.

Intended use also includes paying attention to the complete documentation.

All other uses are considered improper. An improper use is not known to the manufacturer.

Failure to comply with these instructions will not guarantee safe operation and will exclude liability of the manufacturer.

2.2 Material that can be processed and crimping shape

Wires

Flexible PVC cable H05V-K and H07V-K with a cross section of 0.5–2.5 mm²

Wire end ferrules (WEF)

Rittal belted wire end ferrules: www.rittal.com

Crimp form

Trapezium (standard)

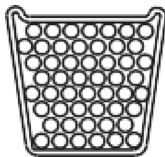

2.3 Safety equipment

The machine is equipped with the following safety devices:

- Safety switch inside on the front plate
- Main valve
- Mains adaptor

These items of safety equipment must not be rendered ineffective. They must be checked once per year by a service technician.

In case of malfunction, the machine must not be operated.

2.4 Personnel

Only trained personnel may operate the machine and perform maintenance activities. Training also includes having fully read the operating instructions.



Repairs may only be performed following consultation with Rittal Service and only by an electrical specialist.



Keep the operating instructions stored so that they can be inspected by operating personnel at any time.

3 Device description

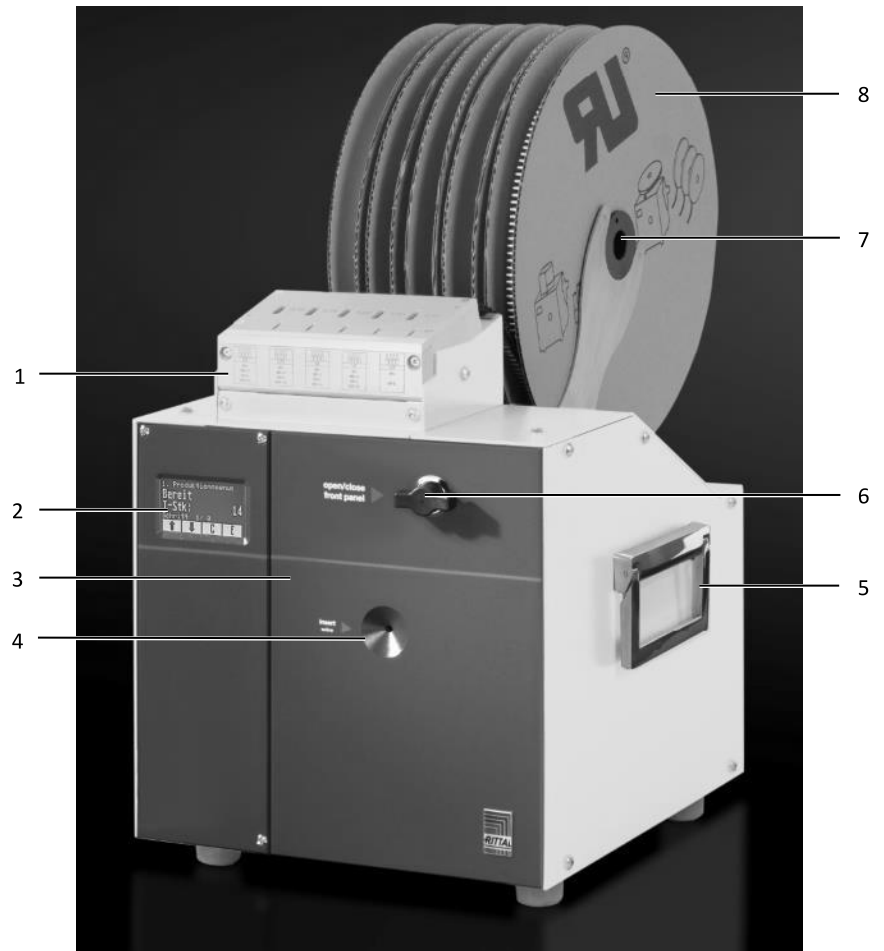

Fig. 1: Front view

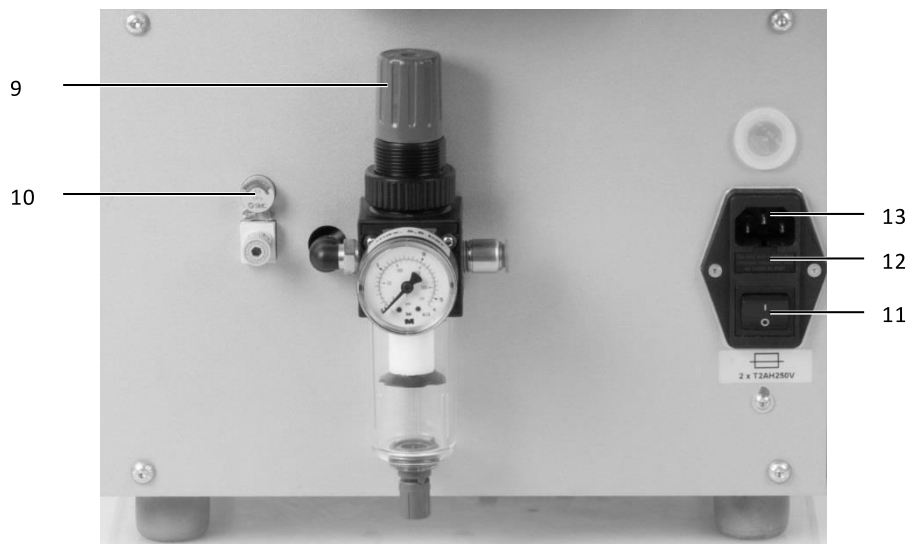

Fig. 2: Rear view

3 Device description

EN

Key

- 1 Transport unit
- 2 Touch display
- 3 Front plate
- 4 Wire insertion funnel
- 5 Carrying handle (both sides)
- 6 Front plate lock
- 7 Reel holder
- 8 Wire end ferrule reel
- 9 Compressed air maintenance unit
- 10 Holding tongs pressure regulator
- 11 On/Off switch
- 12 Fuse compartment
- 13 Mains connection socket

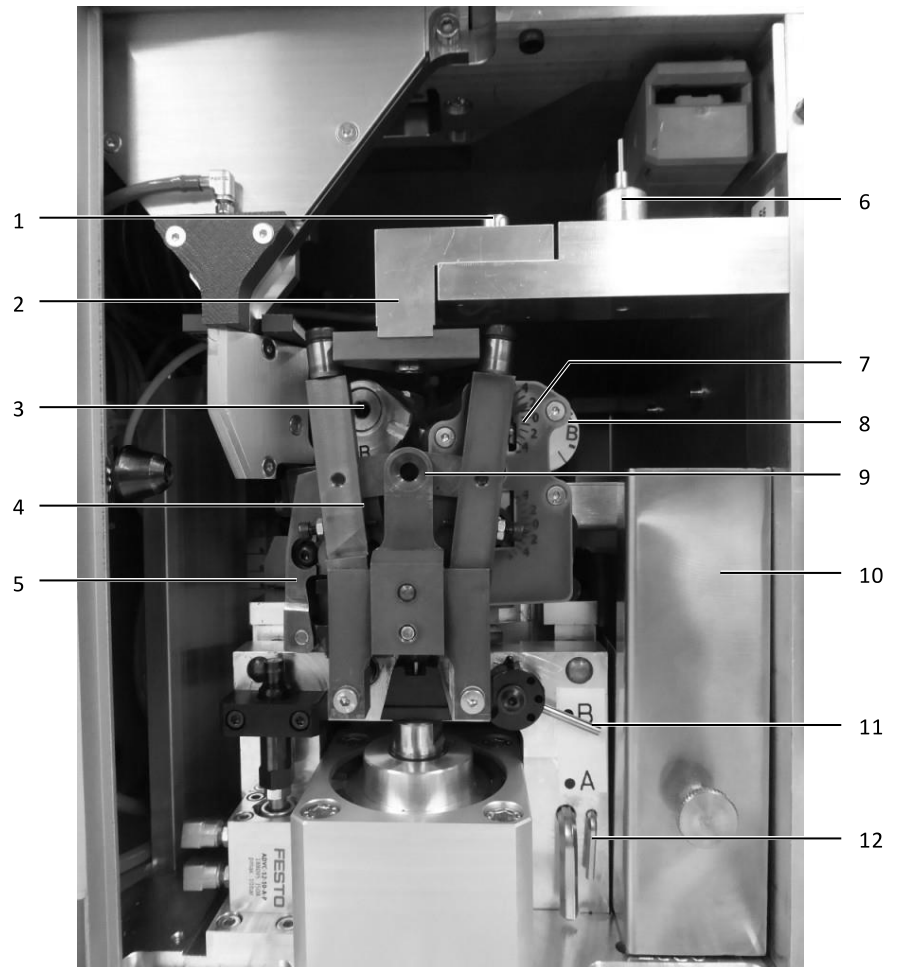

Fig. 3: Internal view

Key

- 1 Opening wedge adjustment
- 2 Opening wedge
- 3 Ferrule stop adjustment
- 4 Crimping unit
- 5 Ferrule-holding unit
- 6 Fixing pin
- 7 Stripping unit
- 8 Release device adjustment
- 9 Wire fixing unit
- 10 Waste container
- 11 Wire fixing unit adjustment
- 12 Allen key 2.5 mm and 5 mm

3.1 Technical data



	Crimping machine RC
Drive	electropneumatic
Supply voltage	1~, 100–240 V AC; 50/60 Hz
Power consumption	16 VA
Fuse (mains filter module)	2 x T2AH250V
Maximum short-circuit current (SCCR)	1.5 kA
Protection type	IP20

3 Device description



EN

	Crimping machine RC
Protection class	I / protective earth conductor
Operating pressure	5.5 bar
Air consumption	approx. 0.9 nl/stop
Cable insertion length	27 mm (1.06") + crimping length
Crimping length	8 mm (0.31") / 10 mm (0.39")
Wire end ferrule	0.5–2.5 mm ² (AWG 20–14)
Crimp form	trapezoid
Cycle time	< 2.0 s
Ambient temperature	
Operation	+5 °C to 40 °C (41 °F to 104 °F)
Storage/transport	-25 °C to +55 °C (brief +70 °C) -13 °F to +131 °F (brief +158 °F)
Environmental conditions	
Operating environment	Operation in closed and dry rooms/workshops
Internal temperature in operation	max. 45 °C (max. 113 °F)
Max. operating altitude	2,000 m above sea level
Humidity	50% at +40 °C (104 °F) (without condensation), 90% at +20 °C (68 °F) (without condensation)
Contamination level	2
Continuous sound pressure level	< 70 dB(A)
Dimensions (W x D x H)	340 x 460 x 560 mm (13.39" x 18.11" x 22.05")
Colour	RAL 9003/RAL 7016
Weight	22 kg (48.50 lbs)

3.2 Type plate

Symbol	Meaning	
	Operate machine only in dry and closed rooms/workshops.	IEC 60417
	Reference to the information enclosed or attached to the product. Directive 2003/15/EU	European Union
	CE identification	European Economic Area (EEA)

4 Transporting and setting up the machine

Symbol	Meaning	
	Number of years that the product can be used as intended. SJ/T 11363-2006 (China RoHS)	China
	Labelled product must not be disposed of with household waste.	WEEE Directive

4 Transporting and setting up the machine

4.1 Installation location

The installation location must meet the following requirements:

- Stable foundation with level, even surface (for machine weight, see section 3.1 "Technical data").
- Keep 30 cm workarea free on both sides and in front of the machine.
- Electricity and compressed air ports easily accessible close by.
- Following the ergonomic principles as a standing or sitting workplace.
- The workplace lighting should be 500-1000 lux.



Note:

Optimum operating pressure is 5.5 bar (± 0.5 bar). When operating pressure is less than 5 bar, you will not achieve satisfactory crimping results.

Operating pressures greater than 6 bar will lead to increased wear on the machine.

4.2 Transporting the machine



Caution!

- Always wear work shoes with foot protection when transporting the machine.

- Empty the waste container prior to each transport.
- Note the weight of the machine (see section 3.1). Use a transport aid if necessary.
- To move the machine, always use the side carrying handles.
- To prepare the machine for shipping (e.g. in the event of servicing), use the transport packaging.

4.3 Unpacking the delivery

- Check the delivery for completeness (for scope of delivery, see section 4.4 "Scope of delivery").
- Store away the transport packaging.
- Ensure that the operating instructions are accessible to the user at all times.

4.4 Scope of delivery

- Stripping and crimping machine
- Mains connection cable (10 A, 250 V)
- Compressed air hose
- Allen key 2.5 mm and 5 mm
- Operating instructions
- Fixing pin

4.5 Establishing connections

- Set up the machine in the intended location.

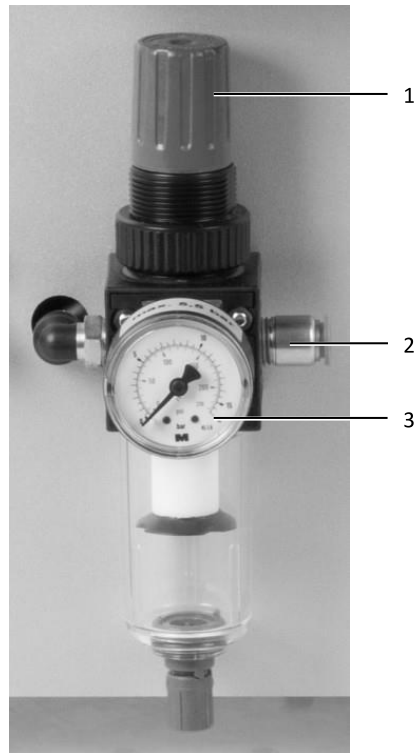

Fig. 4: Establishing connections

- First connect the compressed air hose to the compressed air maintenance unit of the machine (fig. 4, item 2).
- Only then connect the compressed air hose with the compressed air source.
- Check the manometer display (fig. 4, item 3).
The operating pressure must be between 5 and 5.5 bar.
- If necessary readjust the operating temperature. To do this, pull the adjusting screw (fig. 4, item 1) upwards and turn it carefully:
 - To increase the pressure, turn in a clockwise direction
 - To reduce the pressure, turn in an anti-clockwise direction
- Insert the power cable into the mains connection socket of the machine and connect it to the power supply.

5 Setting up the machine

The machine has to be set up in the following situations:

- If a different type of wire end ferrule has to be processed
- Every time the machine is put into operation

During set-up, the following settings must be checked and adjusted if necessary:

- Wire end ferrule reel
- Ferrule cross section
- Ferrule length at four positions (see section 5.4 "Setting the stripping length")
- Reel holder

You can find how to use the crimping machine on our YouTube channel:



Click here!



Note:

The machine must be switched off for setting up.

5.1 Adjust reel holder

If wire end ferrules of length 10 HL or 10S-HL are to be processed, the respective reel holder must be widened.

- If a wire end ferrule reel is mounted, remove it (see section 5.3 "Changing the wire end ferrule reel").
- Remove both fastening screws on the right part of the reel holder (Allen key 2.5 mm).
- Move this part of the reel holder evenly about 2 mm to the right.
- Tighten both fixing screws again.
- Inserting wire end ferrules (see section 5.2 "Inserting wire end ferrules").



Fig. 5: Reel holder (length 8 mm: left, length 10 mm: right)

If wire end ferrules of length 8 mm are to be processed, the respective reel holder must be returned to its original position

5.2 Inserting wire end ferrules

- Arrange the wire end ferrule reels as specified on the transport unit.
- Set up the wire end ferrule reel (fig. 6, item 1) so that an unrolling from bottom to front is ensured.

5 Setting up the machine

EN

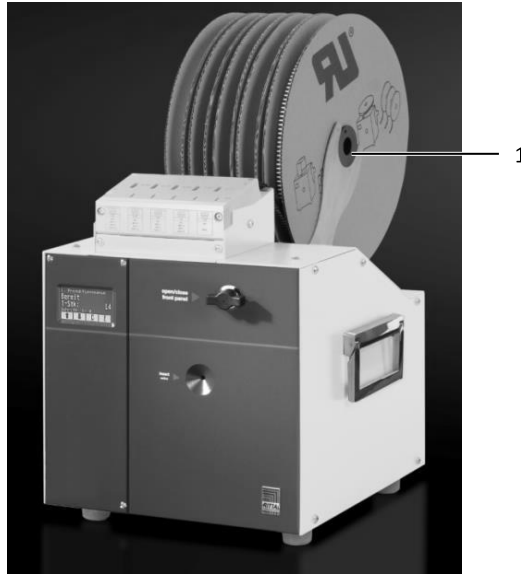

Fig. 6: Position of wire end ferrule reel

- Insert the fixing pin with the small diameter in the front into the lower opening (fig. 7, item 2) of the transport unit.



Fig. 7: Fixing pin bottom

- Insert the wire end ferrule belt into the transport unit until the bottom ferrule snaps into place.
- Check for firm fitting by pulling the wire end ferrule belt carefully.
- Roll up the loose wire end ferrule belt.
- Remove the fixing pin.

5.3 Changing the wire end ferrule reel

- Open the front door to depressurise the machine.
- Insert the fixing pin with the large diameter in the front into the upper opening (fig. 8, item 1) of the transport unit.



Fig. 8: Fixing pin top

- Push the fixing pin all the way up.
- Pull the wire end ferrule belt out of the transport unit.
- Inserting wire end ferrules: see section 5.2 "Inserting wire end ferrules".

5.4 Setting the stripping length

A letter is assigned to each wire end ferrule:

- 10 mm = A
- 8 mm = B

- Check whether the applicable letter (A or B) is set to the following four components:
 - Ferrule stop (fig. 3, item 3)
 - Release device (fig. 3, item 8)
 - Wire insertion unit (fig. 3, item 9)
 - Opening wedge (fig. 3, item 1)

Configuring the ferrule stop

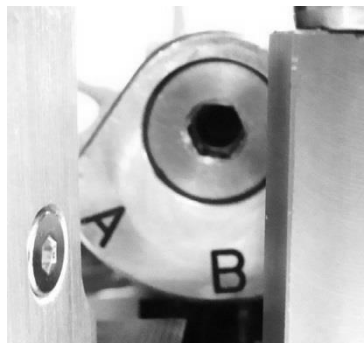

Fig. 9: Ferrule stop configuration

- Swing the tool unit to the right.
- Turn the adjusting wheel with the Allen key (5 mm) so that the required value is underneath.

Adjusting the stripping length on the release device

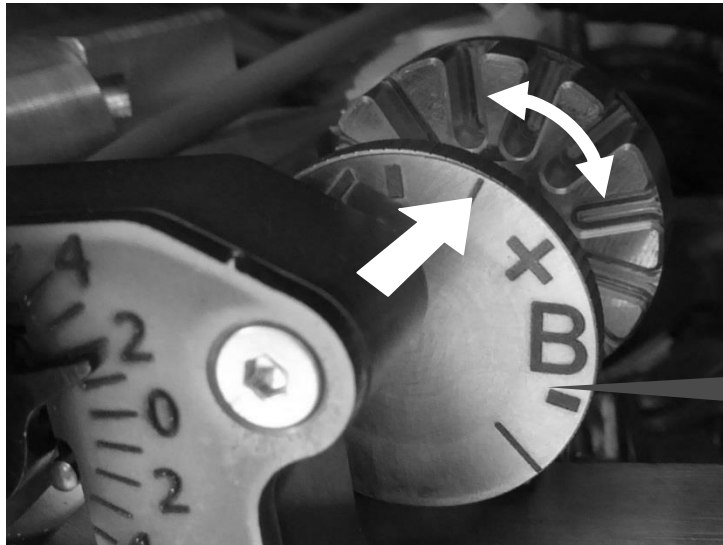

Fig. 10: Release device adjustment (set: B)

You can vary the stripping length using the setting.

- Press the adjusting wheel backwards and turn it so that the required value is at the marked position.
- Release the adjusting wheel so that it latches in.

You can perform fine adjustments within the selected configuration range (A or B):

- To increase the stripping length, turn toward "+"; to reduce the stripping length, turn toward "-".

Configuring the wire insertion unit



Fig. 11: Wire insertion unit configuration (set: B)

- Pull the stranded wire fixing unit (fig. 3, item 9) forwards and set the lever to the required value.

Adjusting the opening wedge



Note:

The opening wedge is only adjustable if the stranded wire fixing unit is in the operating position (see section 7.6 "Servicing the stranded wire fixing unit").

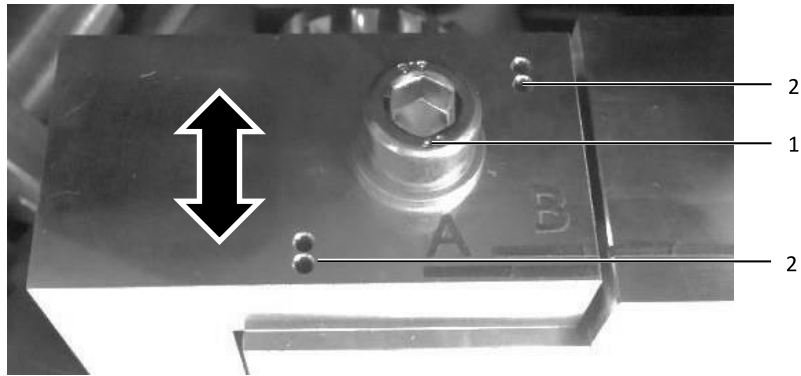

Fig. 12: Adjusting the opening wedge (set: B)

- Release the fixing screw (fig. 12, item 1) until the adjustment plate can be lifted slightly above the catch pins.
- Bring the adjustment plate into the required position. In this process, one of the catch pins must fit into the corresponding openings (fig. 12, item 2).
- Tighten the locking screw (fig. 12, item 1).

5.5 Performing a stripping test

Each time the material to be processed has been changed, a stripping test must be conducted.

- Switch on the mains switch.
- Switch to "Stripping mode" operating mode on the touch display (see section 6.6 "Changing operating mode").
- Insert a wire for stripping.
- Check the result:
 - Is all the stranded wire undamaged?
 - Has stripping been performed straight and evenly?
- Check with an uncrimped wire end ferrule whether the stripping length fits.

5.6 Setting the cutting depth

Depending on hardness and thickness, adjusting the cutting depth for the stripping may be required.

To do this, the blade distance must be modified by shifting the two eccentrics.

- To get to both eccentrics, press the tool unit backwards and swing it to the right.

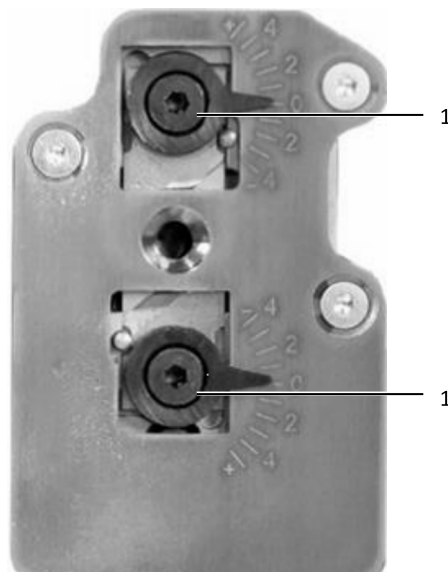

Fig. 13: Stripping unit

- Release both eccentrics screws (fig. 13, item 1) (Allen key 2.5 mm).

- To reduce the cutting depth, move both eccentrics towards "+" (larger blade spacing).
- To increase the cutting depth, move both eccentrics towards "-" (shorter blade spacing).
- Re-apply both eccentrics screws.



Note:

The configuration of both eccentrics must match one another.

6 Operating the machine

6.1 Normal operation

- Insert the wire end ferrule reel.



Note:

- Things to check prior to each activation:

- Is the machine without recognisable defects and damages?
- Is the power cable in fault-free condition?
- Is the compressed air hose in fault-free condition?
- Is the required operating pressure of 5.5 bar present?
- Is the front plate closed?

If one of these defects is present, the machine must not be operated.

- Check whether the defect can be remedied by maintenance. Otherwise, contact your Rittal service.

- Switch on the machine.

The valves audibly start up and a reference run is executed. The touch display shows readiness for operation.

6.2 Inserting the wire



Note:

- Only process wires that are cut cleanly. All stranded wire must finish with the insulation, no stranded wire may be shortened or protrude.
- Ensure that the end of the wire is inserted evenly.



Fig. 14: Insert the wire correctly

- Insert a wire into the insertion funnel.
The material is drawn in slightly and processed automatically. Valve noises are audible during this process.
- Once the processing is complete (no more noises), pull the processed wire(s) out.

6.3 Touch display and operating menus

The touch display indicates the current operating condition. The lower part of the display is touch-sensitive.

You can navigate through the program using the four control buttons.



Fig. 15: Touch display, selection menu

Button	Functions
↑	Select menu (move forwards) or increase value
↓	Select menu (move backwards) or reduce value
C	Exit menu (back to menu 1)
E	Activate selected menu or set value

- To select an operating menu, press the **arrow keys**.
- To switch to the selected menu, press **E**.
- Move to the desired point inside a menu using the **arrow keys**.
- To activate a selected point, press **E**.
- To exit the menu, press **C**.

Only menus 1 to 3 and 10 are relevant for operation.

Here you can:

- Menu 1: Select cross section
- Menu 2: Reset the day's piece quantity
- Menu 3: Change operating mode (standard: crimping and stripping)
- Menu 10: Set language

The remaining menus are only intended for servicing.

6.4 Select cross section

When switching on, the selection menu appears.

The complete display is touch-sensitive in this menu.

0.50 AWG20	0.75	1.00 AWG18	
1.50 AWG16	2.50 AWG14	Ready 8	Status: Ready / Stripping / Crimping day's piece quantity
↑	↓	C	E

- To select the cross section, press the corresponding field.
The selected field is highlighted.
- To reset the day's piece quantity, press **C** for at least 5 seconds.

6 Operating the machine



EN

The day's piece quantity is reset to zero.

- To change to the production menu, press **↑**.

6.5 Resetting the day's piece quantity

- Select Menu 2, if it is not already displayed.



2. Production menu		
Ready		Device ready for operation
DPQ	5	Day's piece quantity: Quantity of processed pieces since the last reset
Step	1/0	
  C E		

- To reset the day's piece quantity, press **C** for at least 5 seconds.
The day's piece quantity is reset to zero.

6.6 Changing operating mode

- Select Menu 3.



The current operating mode is displayed.

3. Stripping menu		
Stripping:	0	0 = Stripping and crimping 1 = Only stripping
  C E		

- To switch operating mode, press **E**.
The selected operating mode is immediately active.
- To return to the selection menu, press **C**, or choose another menu with the **arrow keys**.

6.7 Displaying counters and processing times

- Select Menu 4.

4. Operating data menu		
Tcounter:	400002	Total counter: Number of completed work cycles
Pr.Time:	1.946 s	Processing time: Work cycle duration (stripping and crimping)
Service:	– 1	Prefix sign and service counter
  C E		



The total counter counts the work cycles during the entire lifetime of the machine. The service interval of the machine is 400,000 work cycles. The service counter counts down instead of up; starting at 400,000. Once 400,000 work cycles have been completed, the service counter stands at 0. When the machine is next start-

ed, the service notification is displayed (see section 6.9 "Service display"). The service counter counts up again. The negative prefix sign indicates that a counting cycle has been completed. The service technician sets the service counter to 400,000.

6.8 Set language



- Select Menu 10.
- To activate the menu, press E.

10. Language

  C E

- Press  until the desired language is displayed. The selected language is adopted immediately.
- To return to the selection menu, press C, or choose another menu with the arrow keys.

6.9 Service display

2. Production menu	
Ready	Device is ready for operation
——— Service ———	Service display appears after every 400,000 work cycles.
Step: 2/0	
  C E	

When the machine is switched on, the service display flashes three times. After that the machine is ready for operation.



Note:

- To maintain the machine's performance capability for as long as possible, you should keep to the service intervals specified.
- Interim service after 400,000 work cycles
 - Full service after 800,000 work cycles
- Refer to the Rittal representative responsible for your country.

6.10 Switching off the machine

- Switch the machine off. The valves are audibly relieved. The display goes out.



Note:

When you finish the work, you should empty the waste container and put it back into the machine (see section 7.4 "Emptying waste container").

7 Cleaning and maintaining the machine

7.1 Cleaning the machine externally

The machine should be freed of dust on a regular basis. It must be cleaned externally as and when required.



Note:

Cleaning the inside is part of maintenance which must only be carried out by trained personnel.

- Make sure that the machine is switched off.

Attention!

The display can be damaged!

Using unsuitable cleaning agents may scratch or damage the display.

- Clean the display carefully, either using a special cleaning cloth for display surfaces, or with a soft cloth and some display cleaner.

- Clean the surface of the machine with a damp cloth. If necessary, use soap-based cleaning agents. Do not use any abrasive cleaners or solvents.

7.2 Machine maintenance

In order to ensure fault-free operation, the described maintenance tasks (see section 7.3 "Maintenance schedule") must be performed at the specified intervals.



Warning!

Potential risk of fatality due to electric shock!

When working on the inside of the machine, non-insulated parts may be touched.

- Switch the machine off.
- First remove the compressed air hose from the compressed air source, then from the maintenance unit.
- Pull the power plug.
- Open the front plate and place it down carefully.



Note:

In order to be able to access all the areas inside the machine easily, you should remove the waste container when starting maintenance work. Remember to put it back in once work is complete.



Note:

Keep the following ready for maintenance work:

- Allen key set
- Brush and cleaning cloth
- Lubricant
 - PTFE oil
 - Lubricating grease (suitable for rolling bearings)

7.3 Maintenance schedule

Maintenance item	Interval / maintenance activity	See section
------------------	---------------------------------	-------------

7 Cleaning and maintaining the machine

EN

Maintenance item	Interval / maintenance activity	See section
	Daily	
1	Emptying waste container	7.4
	Weekly	
2	Cleaning wire-holding tongs	7.5
3	Stranded wire fixing unit: Cleaning insertion funnel	7.6
4	Cleaning stripping unit, checking stripping blades	7.7
6	Cleaning the interior	7.9
	Monthly	
2	Wire-holding tongs: Oil pivot point and contact areas	7.5
3	Stranded wire fixing unit: Oil pivot point and rollers	7.6
5	Crimp tool: Rollers and ferrule-holding tongs	7.8
	Quarterly	
7	Tool slide	7.10
8	Servicing the transport unit	7.11
	As required	
9	Compressed air maintenance unit: Draining condensate; cleaning/changing filters	7.12

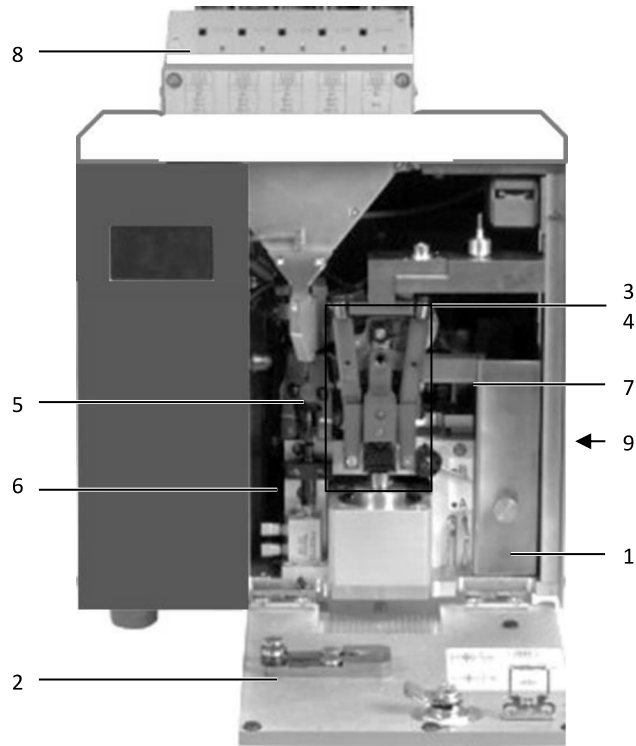

Fig. 16: Maintenance item overview

7.4 Emptying waste container

Depending on the thickness of the stripped material, the waste container should be emptied after every 2,000 to 6,000 cycles. The waste container must also be emptied before each instance of transport or shipping.

- Pull out the waste container and empty it.
- Re-insert the waste container.

7.5 Servicing the wire-holding tongs

- Clean the wire-holding tongs with a brush.

Additional monthly maintenance:

- Oil the wire-holding tongs at the rotation points (fig. 17, item 1) and at the contact areas (fig. 17, item 2) of the rollers.

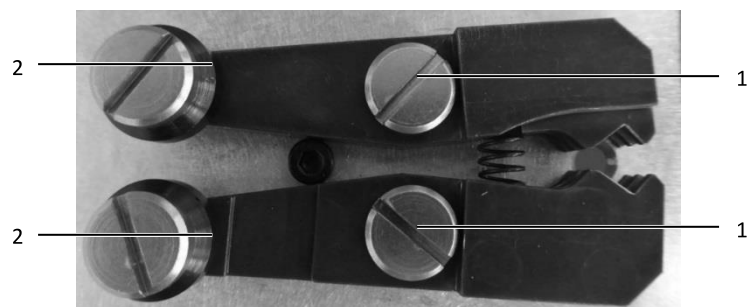

Fig. 17: Wire-holding tongs

7.6 Servicing the stranded wire fixing unit

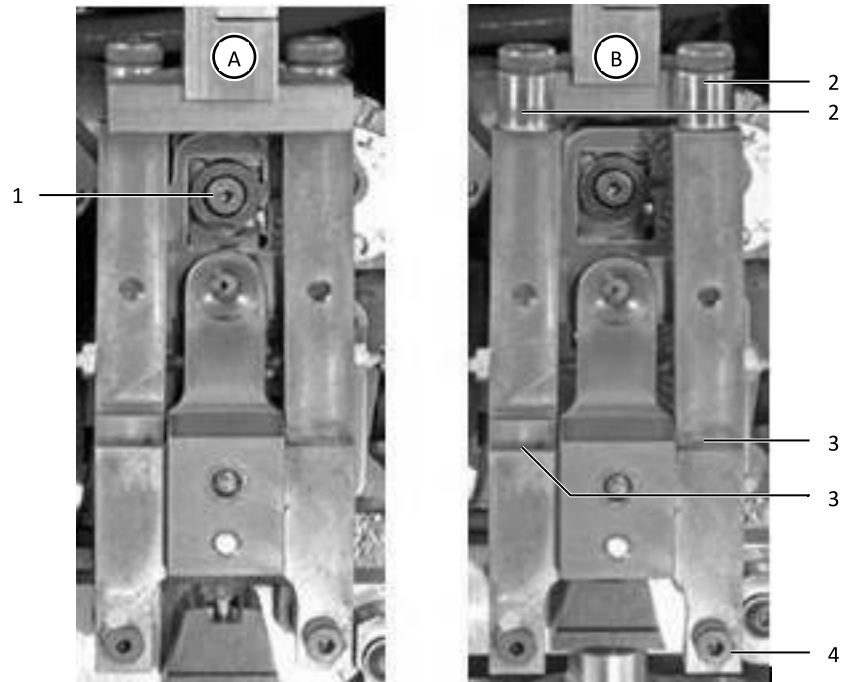

Fig. 18: Stranded wire fixing unit in operating position (A) and pulled forward (B)

- Clean the insertion funnel (fig. 18, item 1) with a brush.
- If necessary, use a soft cloth and some spirit.

Additional monthly maintenance:

- Pull the stranded wire fixing unit forwards (fig. 18, item B).
- Check whether the rollers (fig. 18, item 2) are able to move freely.
If necessary, lubricate the rotation points of the rollers.
- Oil the rotation points (fig. 18, item 3) of the stranded wire fixing unit.

7.7 Servicing the stripping unit

- Make sure that the stranded wire fixing unit is in the front position.
- Press the tool unit backwards and swing it to the right.

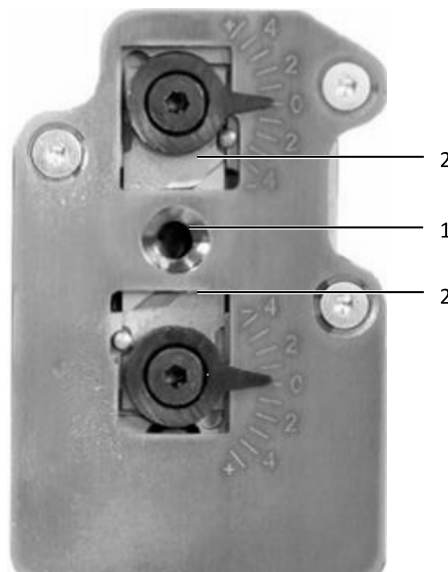

Fig. 19: Stripping unit

- Clean the area around the hole (fig. 19, item 1) with a brush.

- If necessary, use a soft cloth and some spirit.
- Check the blade (fig. 19, item 2). If necessary, replace the blades (see section 8.3 "Replacing the stripping blade").

7.8 Servicing the crimping tool

To reach the crimping tool, you must dismantle the stranded wire fixing unit.

- Ensure that the stranded wire fixing unit is located in the front position (fig. 18, item B).
- Remove the bottom right screw of the stranded wire fixing unit (fig. 18, item 4).
- Carefully pull out forwards the stranded wire fixing unit.
- Tilt the stranded wire fixing unit to the side and place it down carefully.



Fig. 20: Detached stranded wire fixing unit

Additional monthly maintenance:

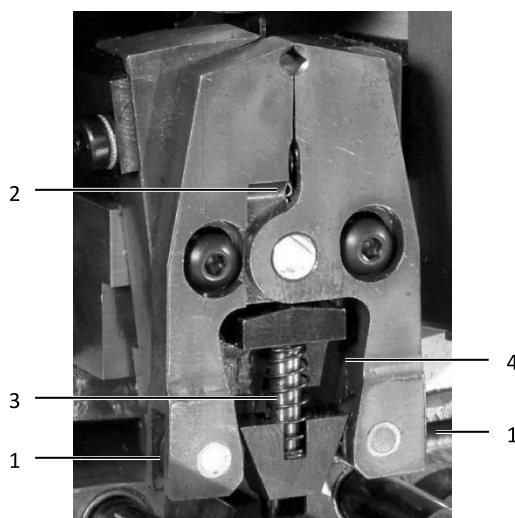

Fig. 21: Crimp tool

- Check whether the rollers (fig. 21, item 1) on the crimp tool can move freely.
- Check whether the rollers (fig. 21, item 2) on the ferrule-holding tongs can move freely.
- If necessary, oil both points.

- Oil the guide pin (fig. 21, item 3) of the ferrule-holding unit.
- Oil the lateral running surfaces (fig. 21, item 4) of the ferrule-holding unit.
- Re-insert the stranded wire fixing unit and tighten it.

7.9 Cleaning the interior

- Remove the waste container.
- Clean the inside of the machine with a brush and, if necessary, with a vacuum cleaner.



Note:

- Never use compressed air for cleaning the inside, because otherwise small particles (e.g. stripping residues) become inaccessible on the inside of the machine. This may result in malfunctions and operational stoppages.

7.10 Servicing the tool slide

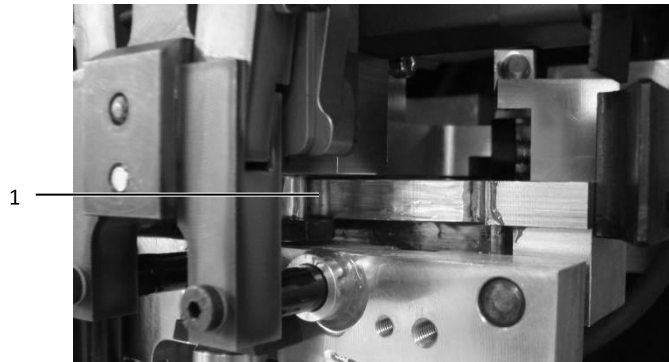

Fig. 22: Tool slide

Quarterly:

- Pull the stranded wire fixing unit forwards.
- Lubricate the contact surface (fig. 22, item 1).
- Bring the stranded wire fixing unit back into position.

7.11 Servicing the transport unit

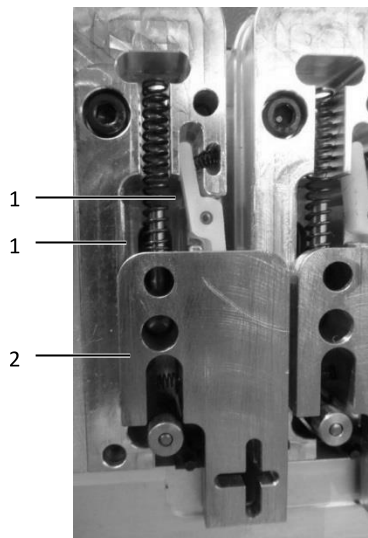

Fig. 23: Transport unit

- Remove the wire end ferrule reel (see section 5.1 "Adjust reel holder").
- Release the screws and remove the cover (fig. 16, item 8)

- Apply very little oil to the aluminum on both sides (fig. 23, item 1) of the guide groove.
- Move up and down with the brass slide (fig. 23, item 2) to distribute the oil.
- Fasten the cover again.

7.12 Servicing the compressed air maintenance unit



Caution!

Risk of injury posed by electric shock!

- Make sure that the machine is switched off and the mains plug has been pulled.



Caution!

Risk of injury posed by compressed air hoseswinging around!

- Make sure that the compressed air hose is disconnected from the compressed air source.

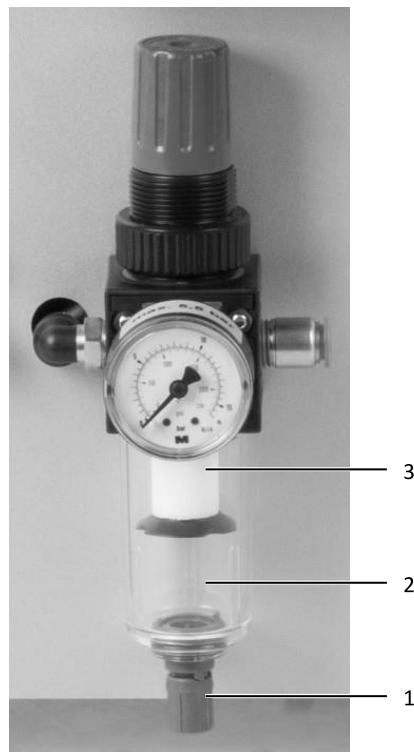

Fig. 24: Compressed air maintenance unit

As required:

- To drain the condensate press the drain plug (fig. 24, item 1) upwards.
- To change the filter, unscrew the condensate tank (fig. 24, item 2) and screw off the filter (fig. 24, item 3).
- Insert a new filter and screw the condensate tank back on tightly.

8 Troubleshooting



Note:

If a fault cannot be resolved by means of the actions described here, please refer to Rittal Service.

8.1 Fault table

Fault	Possible cause	Recommended action
Machine cannot be switched on.	No power supply	<ul style="list-style-type: none"> ■ Check the power cable and the mains connections. ■ Check fuses.
Cannot start if wire is inserted.	Start sensor (S1) is blocked by stripping leftovers.	<ul style="list-style-type: none"> ■ Open the front plate. ■ Swing the tool unit to the right. ■ Pull the stranded wire fixing unit forwards. ■ Remove the leftovers from the stripping unit. ■ Bring all components back into their original positions.
	Wire has been inserted incorrectly.	<ul style="list-style-type: none"> ■ Insert the wire straight.
The wire is only stripped and not crimped.	"Only stripping" operating mode is set.	<ul style="list-style-type: none"> ■ Change the operating mode to "Standard" (setting "0" in Menu 3).
	Settings on the machine do not match the ferrule used.	<ul style="list-style-type: none"> ■ Check whether the settings for the ferrule cross section and crimp length match the used ferrule.
	No wire end ferrule reel inserted	<ul style="list-style-type: none"> ■ Insert a wire end ferrule reel.
Increased scrap	Waste container is full	<ul style="list-style-type: none"> ■ Empty the waste container (see section 7.4 "Emptying waste container").
	Stripping blades damaged or incorrectly installed	<ul style="list-style-type: none"> ■ Check the seating of the stripping blades (see section 7.7 "Servicing the stripping unit"). ■ Correct the seating of the stripping blades or replace them (see section 8.3 "Replacing the stripping blade").
	Stripping leftovers between tool unit and right stop	<ul style="list-style-type: none"> ■ Remove the stripping leftovers.
	A second ferrule is located in the ferrule-holding unit	<ul style="list-style-type: none"> ■ Remove the ferrule.

8.2 Wearing parts

Product	Order no.
Titanium stripping blades	4050.466

8.3 Replacing the stripping blade

**Warning!****Potential risk of fatality due to electric shock!**

When working on the inside of the machine, non-insulated parts may be touched.

- Switch the machine off.
- Remove the compressed air hose from the compressed air source.
- Pull the power plug.
- Open the front plate and place it down carefully.

8 Troubleshooting

EN



Caution!

Risk of injury posed by sharp blades!

- Use forceps to change the blades.
- Dispose of the removed blades in a separate container.



Note:

All present blades must be replaced each time the knife is changed.

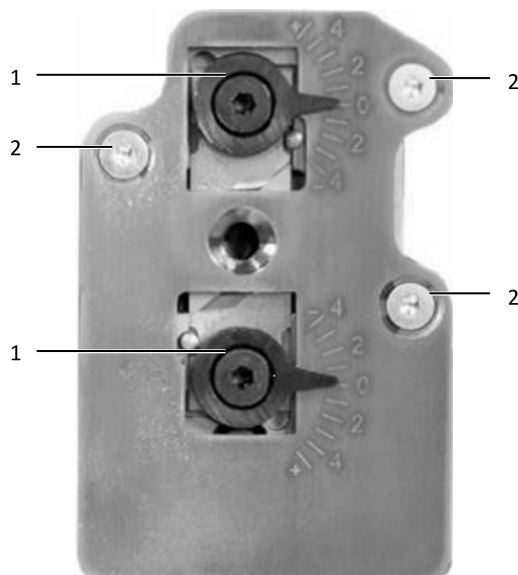

Fig. 25: Stripping unit

- Remove both eccentrics (fig. 25, item 1) (Allen key 2.5 mm).
- Release the fixing screws (fig. 25, item 2) (Allen key 2.0 mm) and remove the cover.
- Replace all present blades with new ones.

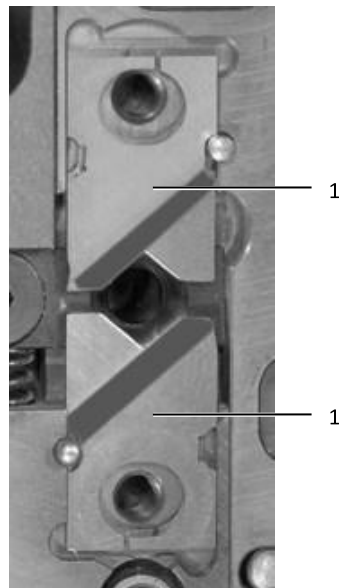

Fig. 26: Insert blades

- Assemble each blade pair so that the bevelled edges point outwards (marked red in fig. 26).
- Place both blade pairs in the holder.
- Fix the cover back on.
- Fix both eccentrics so that they are in position "0".
- Conduct a stripping test (see section 5.4 "Setting the stripping length").

8.4 Replacing fuses

- Make sure that the machine is switched off.
- Remove the power plug.

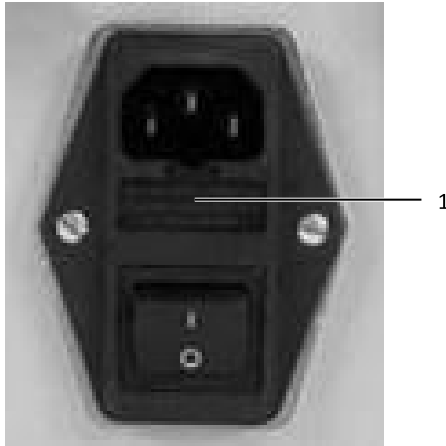

Fig. 27: Opening the fuse compartment

- Lever the fuse compartment (fig. 27, item 1) out of the mains filter unit using a slotted screwdriver.
- Replace both fuses with new ones (2 x T2AH250V).
- Put the fuse compartment back into the mains filter unit.

9 Taking the machine out of operation and disposing of it

9.1 Taking the machine out of operation

- Switch the machine off.
- Pull the power plug.
- Remove the compressed air hose from the compressed air source.
- Remove the compressed air hose from the compressed air maintenance unit.
- Open the front plate.
- Remove the wire end ferrule belt from the transport unit.
- Turn the wire end ferrule reel counterclockwise until the wire end ferrule belt is completely removed from the machine.
- Remove the wire end ferrule reel.
- Empty the waste container and put it back in the machine.
- Close the front plate.
- Pack the machine in the original packaging.

The machine is now ready for transport and, if necessary, disposal.

9.2 Disposing of the machine

- Take the machine out of operation as described in section 9.1 "Taking the machine out of operation".
- Make sure that the machine is disposed of in accordance with national and local regulations.

9 Taking the machine out of operation and disposing of it

EN



The machine must not be disposed of as domestic waste.
The machine must be disposed of in an environmentally-friendly and professional manner.



Note:
You can send the machine to Rittal for disposal. Refer to the representative responsible for your country.

Rittal – The System.

Faster – better – everywhere.

- Enclosures
- Power Distribution
- Climate Control
- IT Infrastructure
- Software & Services

You can find the contact details of all Rittal companies throughout the world here.



www.rittal.com/contact

RITTAL GmbH & Co. KG
Postfach 1662 · D-35726 Herborn
Phone +49(0)2772 505-0 · Fax +49(0)2772 505-2319
E-mail: info@rittal.de · www.rittal.com

07.2021 / D-0100-00000018-02-EN

ENCLOSURES

POWER DISTRIBUTION

CLIMATE CONTROL

IT INFRASTRUCTURE

SOFTWARE & SERVICES

FRIEDHELM LOH GROUP

