

Rittal – The System.

Faster – better – everywhere.

Compact enclosures AX Small enclosures KX

Technical documentation

PE conductor connection, current carrying capacity



ENCLOSURES

POWER DISTRIBUTION

CLIMATE CONTROL

IT INFRASTRUCTURE

SOFTWARE & SERVICES



FRIEDHELM LOH GROUP

Compact enclosures AX/Small enclosures KX

Contents

Contents

1. General remarks

1.1 Introduction	3
1.2 Notes on the design of the earthing system	3
1.3 Regulations/standards	3

2. Earthing connection points

2.1 Compact enclosure AX, enclosure	4
2.2 Compact enclosure AX, mounting plate	4
2.3 Compact enclosure AX, door/perforated door strip	5
2.4 Small enclosure KX, enclosure	6
2.5 Small enclosure KX, cover/door	7
2.6 Small enclosure KX, mounting plate	7

3. Automatic contacting

3.1 Compact enclosure AX, gland plate	8
3.2 Compact enclosure AX, mounting plate	8
3.3 Terminal box KX, gland plate	8

4. Permissible symmetrical short-circuit current of earthing straps

4.1 Earthing straps, PVC insulated	9
4.2 Earthing straps, bare conductors	9

5. Test methods and evaluation

5.1 Test methods	10
5.2 Notes of evaluation	10

Note:

The following values are based on a standard spray finish. Where special paints are used, contact conditions may vary.

1. General remarks

1.1 Introduction

Even careful design of switchgear and expert advanced planning cannot always prevent unwanted short-circuits when operating these systems. Appropriate safety measures must be taken to prevent damage to personnel, property and electrical equipment which includes enclosures. These must therefore be equipped with appropriate short-circuit provisions.

They must be able to conduct any short-circuit currents occurring for the fault duration without impairing safety.

This document deals specifically with earthing connections via built-in mechanical components within AX compact enclosures and KX small enclosures.

The short-circuit resistance of a switchgear combination is a measurement of its resistance to the dynamic and thermal stresses. Thermal stress is of particular interest when observing the behaviour of enclosures or parts of enclosures.

When assessing permissible thermal stress, the decisive factor is the root mean square of the short-circuit current throughout its duration.

The connection points and elements through which the short-circuit current flows generate heat due to their electrical resistance. This heat must be withstood by the connection points. They must not be destroyed to such an extent that they are no longer able to fulfil their safety function.

Short-circuit stress is essentially influenced by the following factors:

- The duration of the short-circuit
Limitation by quick-breaking safety devices such as fuses, modern power switches with zero-current cut-off or current limitation etc.
- Impedance of the system short-circuit loop
This depends on the distance from the transformer and the capacity of the supplying system.
- Construction and design of the earthing connection point
This is usually prescribed or suggested by the manufacturer of the operating equipment.

The aim of this document is to provide the planning engineer with data to enable fast, reliable implementation of the required adjustments at the project planning stage. Details of the test methods used and the conversion for existing values can be found in the appendix.

The measurements quoted in this document are the results of a single test and are therefore subject to fluctuations which may depend upon both the test layout and the specimen (short-circuit current cycle). The manufacturer of the switching system should therefore include corresponding safety allowances in the design. In particular, the mounting technology must comply with our specifications.

1.2 Notes on the design of the earthing system

DIN EN 62 208, point 8.5, requires the creation of electrical continuity for the PE conductor circuit, either via the conductive parts of the enclosure, or via a separate PE conductor, or both.

In enclosure series AX/KX, automatic contacting between the enclosure and the mounting plate / gland plates has been incorporated into the design. The designer must determine whether or not the automatic contacting is sufficient for the earthing system. To incorporate the door and/or cover into the safety measure "protection from indirect contact via automatic deactivation", you will need to connect a separate PE conductor. This should be dimensioned to ensure the correct functioning of the safety measure at all times, whilst complying with all relevant standards. Suitable connection options are provided on the covers and doors and are documented in this brochure. If equipment is secured to the door, cover or other similar parts, the cross-section of the PE conductor should be dimensioned to match the largest cross-section of the supply lead to that equipment.

1.3 Regulations/standards

The following standards must be observed:

- DIN VDE 0100 – 200 (2006-06)
Low-voltage installations
– General terminology
- DIN VDE 0100 – 410 (2018-10)
Low-voltage installations
– Part 4-41: Protection for safety
- DIN VDE 0100 – 540 (2012-06)
Low-voltage installations
– Selection and erection of electrical equipment –
Earthing arrangements and protective conductors
- DIN EN 60 865-1 (VDE 0103 : 2012-09)
Short-circuit currents – Calculation of effects
– Part 1: Definitions and calculation methods
- DIN EN 60 204-1 (VDE 0113-1 : 2014-10)
Electrical equipment of machines
- DIN EN 61439-1 (VDE 0660-600-1 : 2012-06)
Low-voltage switchgear and controlgear assemblies;
– Part 1: General rules
- DIN EN 62 208 (VDE 0660-511 : 2012-06)
Empty enclosures for low-voltage switchgear and controlgear assemblies;
– General requirements

¹⁾ Contact with an active conductor of a defined cross-section

Compact enclosures AX

PE conductor connection

2. Earthing connection points

2.1 Enclosure

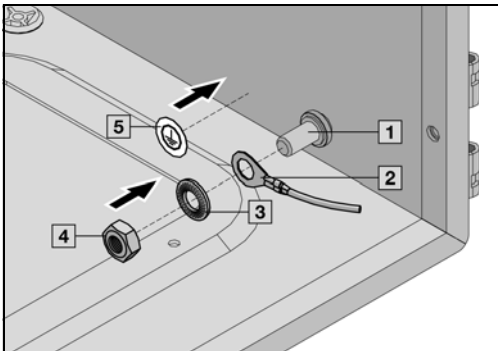

Sheet steel

- 1 Welded stud with disc M8
- 2 Ring terminal with PE conductor
- 3 Contact washer type S 8.2
- 4 Hex nut M8
- 5 PE conductor sticker

Rated surge current resistance	$I_p = 40.4 \text{ kA}$
Thermal equivalent short-time current (at $T_k = 50 \text{ ms}$)	$I_{th} = 21.4 \text{ kA}$
Joule heat value	$I^2t \text{ value} = 23.3 \cdot 10^6 \text{ A}^2\text{s}$
Recommended tightening torque	$M_A = 10 \text{ Nm}$

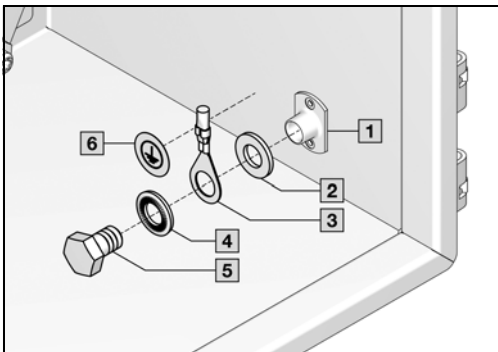

Stainless steel

- 1 Welded nut
- 2 Washer
- 3 Ring terminal with PE conductor
- 4 Contact washer type S 8.2
- 5 Hex screw M8
- 6 PE conductor sticker

Rated surge current resistance	$I_p = 13.0 \text{ kA}$
Thermal equivalent short-time current (at $T_k = 48 \text{ ms}$)	$I_{th} = 8.0 \text{ kA}$
Joule heat value	$I^2t \text{ value} = 3.1 \cdot 10^6 \text{ A}^2\text{s}$
Recommended tightening torque	$M_A = 10 \text{ Nm}$

2.2 Mounting plate

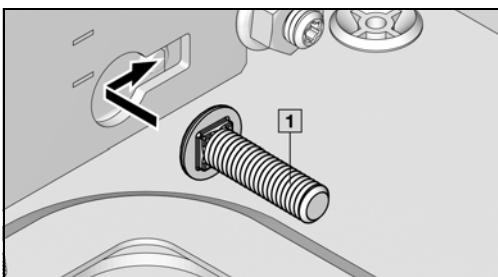

Sheet steel/stainless steel

- 1 Lock bolt M8
- 2 Hex nut with flange M8
- 3 Ring terminal with PE conductor
- 4 Contact washer type S 8.2
- 5 Hex nut M8

Rated surge current resistance	$I_p = 37.4 \text{ kA}$
Thermal equivalent short-time current (at $T_k = 51 \text{ ms}$)	$I_{th} = 20.0 \text{ kA}$
Joule heat value	$I^2t \text{ value} = 20.6 \cdot 10^6 \text{ A}^2\text{s}$
Recommended tightening torque	$M_A = 10 \text{ Nm}$

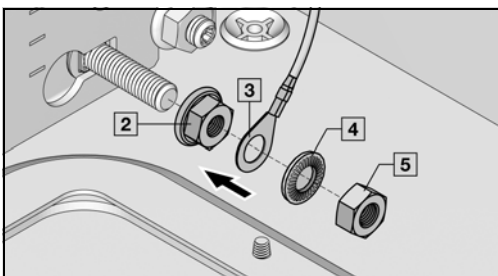

2. Earthing connection points

2.3 Door/perforated door strip

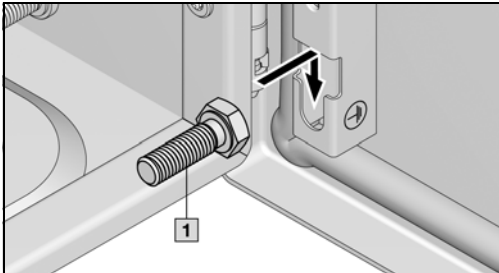

Sheet steel

- 1 Hex screw M8 x 25
- 2 Contact washer type K 8.2
- 3 Hex nut M8
- 4 Ring terminal with PE conductor
- 5 Contact washer type S 8.2

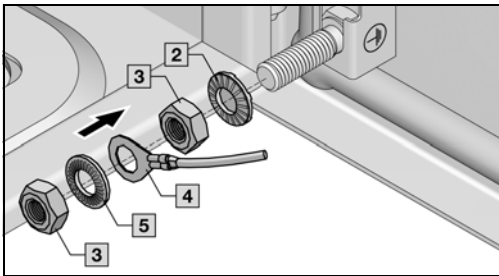

Rated surge current resistance	$I_p = 3.5 \text{ kA}$
Thermal equivalent short-time current (at $T_k = 47 \text{ ms}$)	$I_{th} = 2.2 \text{ kA}$
Joule heat value	$I^2t \text{ value} = 0.2 \cdot 10^6 \text{ A}^2\text{s}$
Recommended tightening torque	$M_A = 10 \text{ Nm}$

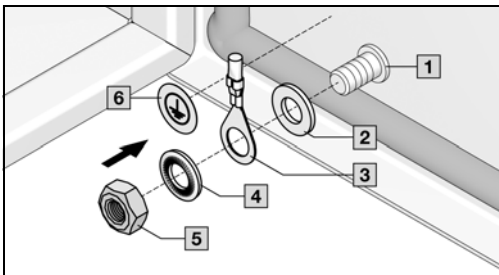

Stainless steel

- 1 Welded stud with M8
- 2 Washer 8.4
- 3 Ring terminal with PE conductor
- 4 Contact washer type S 8.2
- 5 Hex nut M8

Rated surge current resistance	$I_p = 20.2 \text{ kA}$
Thermal equivalent short-time current (at $T_k = 51 \text{ ms}$)	$I_{th} = 12.5 \text{ kA}$
Joule heat value	$I^2t \text{ value} = 8.0 \cdot 10^6 \text{ A}^2\text{s}$
Recommended tightening torque	$M_A = 10 \text{ Nm}$

Small enclosures KX

PE conductor connection

2. Earthing connection points

2.4 Enclosure

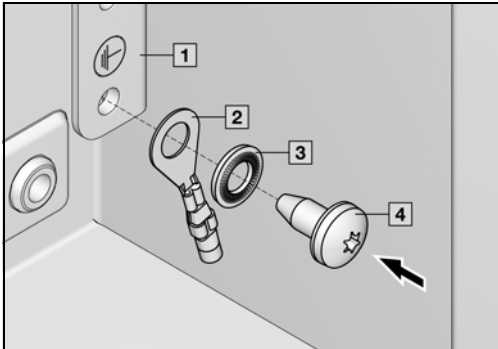

Sheet steel

- 1 Perforated mounting strip
- 2 Ring terminal with PE conductor
- 3 Contact washer type S 6.2
- 4 Screw 6 x 13

Rated surge current resistance	$I_p = 6.1 \text{ kA}$
Thermal equivalent short-time current (at $T_k = 50 \text{ ms}$)	$I_{th} = 3.8 \text{ kA}$
Joule heat value	$I^2t \text{ value} = 0.7 \cdot 10^6 \text{ A}^2\text{s}$
Recommended tightening torque	$M_A = 5 \text{ Nm}$

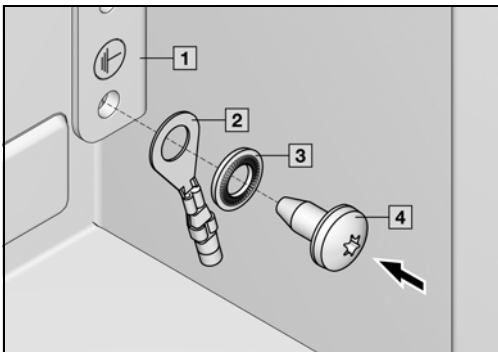

Stainless steel

- 1 Perforated mounting strip
- 2 Ring terminal with PE conductor
- 3 Contact washer type S 6.2
- 4 Screw 6 x 13

Rated surge current resistance	$I_p = 15.0 \text{ kA}$
Thermal equivalent short-time current (at $T_k = 51 \text{ ms}$)	$I_{th} = 9.4 \text{ kA}$
Joule heat value	$I^2t \text{ value} = 4.5 \cdot 10^6 \text{ A}^2\text{s}$
Recommended tightening torque	$M_A = 5 \text{ Nm}$

2. Earthing connection points

2.5 Cover/door

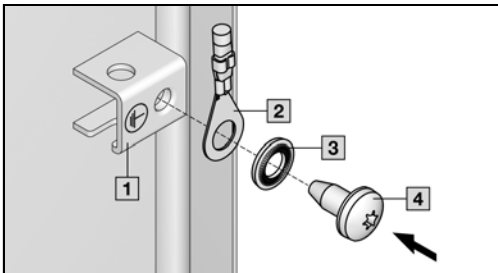

Sheet steel

- 1 PE conductor connection
- 2 Ring terminal with PE conductor
- 3 Contact washer type S 6.2
- 4 Screw 6 x 13

Rated surge current resistance	$I_p = 6.1 \text{ kA}$
Thermal equivalent short-time current (at $T_k = 50 \text{ ms}$)	$I_{th} = 3.8 \text{ kA}$
Joule heat value	$I^2t \text{ value} = 0.7 \cdot 10^6 \text{ A}^2\text{s}$
Recommended tightening torque	$M_A = 5 \text{ Nm}$

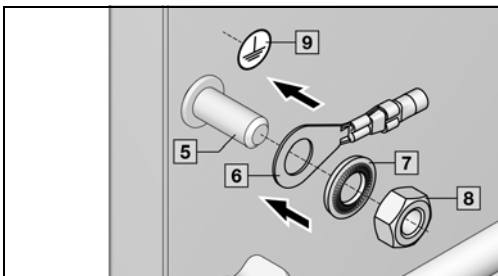

Stainless steel

- 5 Welded stud with disc M6
- 6 Ring terminal with PE conductor
- 7 Contact washer type S 6.2
- 8 Hex nut M6
- 9 PE conductor sticker

Rated surge current resistance	$I_p = 15.3 \text{ kA}$
Thermal equivalent short-time current (at $T_k = 50 \text{ ms}$)	$I_{th} = 9.6 \text{ kA}$
Joule heat value	$I^2t \text{ value} = 4.6 \cdot 10^6 \text{ A}^2\text{s}$
Recommended tightening torque	$M_A = 5 \text{ Nm}$

2.6 Mounting plate

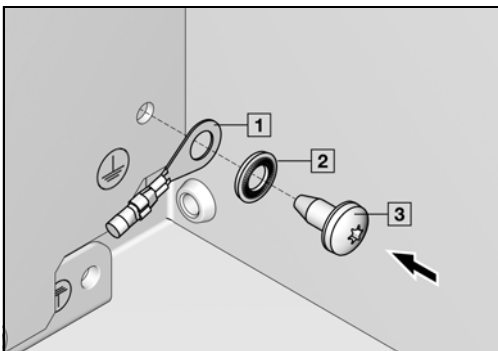

Sheet steel/stainless steel

- 1 Ring terminal with PE conductor
- 2 Contact washer type S 6.2
- 3 Screw 6 x 13

Rated surge current resistance	$I_p = 20.0 \text{ kA}$
Thermal equivalent short-time current (at $T_k = 51 \text{ ms}$)	$I_{th} = 12.2 \text{ kA}$
Joule heat value	$I^2t \text{ value} = 7.7 \cdot 10^6 \text{ A}^2\text{s}$
Recommended tightening torque	$M_A = 5 \text{ Nm}$

Compact enclosures AX/Small enclosures KX

Automatic contacting

3. Automatic contacting

3.1 Compact enclosure AX, gland plate

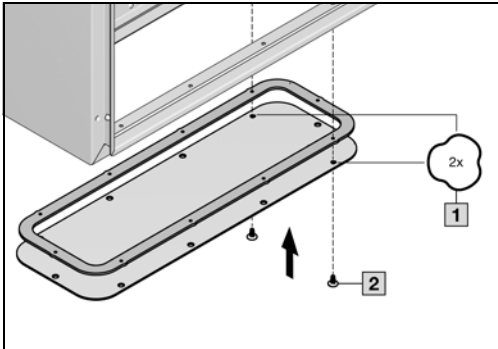

Sheet steel

- 1 Gland plate hole with special geometry
- 2 Assembly screw 5 x 10

Rated surge current resistance	$I_p = 1.0 \text{ kA}$
Thermal equivalent short-time current (at $T_k = 48 \text{ ms}$)	$I_{th} = 0.7 \text{ kA}$
Joule heat value	$I^2t \text{ value} = 0.023 \cdot 10^6 \text{ A}^2\text{s}$
Recommended tightening torque	$M_A = 2.5 \text{ Nm}$

3.2 Compact enclosure AX, mounting plate

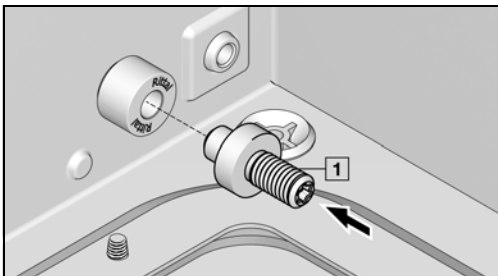

Sheet steel/stainless steel

- 1 Threaded bolt with collar
- 2 Hex nut with flange M8

Rated surge current resistance	$I_p = 10.1 \text{ kA}$
Thermal equivalent short-time current (at $T_k = 50 \text{ ms}$)	$I_{th} = 6.2 \text{ kA}$
Joule heat value	$I^2t \text{ value} = 1.9 \cdot 10^6 \text{ A}^2\text{s}$
Recommended tightening torque	$M_A = 8 \text{ Nm}$

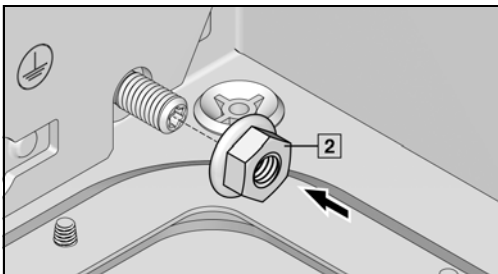

3.3 Terminal box KX, gland plate

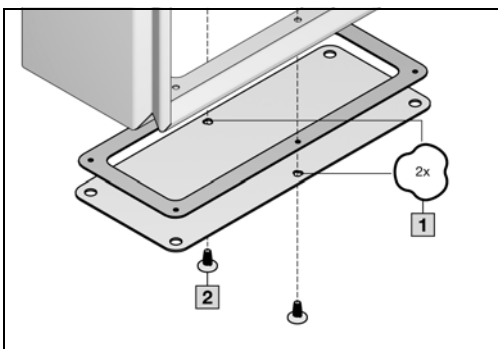

Sheet steel

- 1 Gland plate hole with special geometry
- 2 Assembly screw 5 x 10

Rated surge current resistance	$I_p = 1.0 \text{ kA}$
Thermal equivalent short-time current (at $T_k = 48 \text{ ms}$)	$I_{th} = 0.7 \text{ kA}$
Joule heat value	$I^2t \text{ value} = 0.023 \cdot 10^6 \text{ A}^2\text{s}$
Recommended tightening torque	$M_A = 2.5 \text{ Nm}$

4. Permissible symmetrical short-circuit current of earthing straps

4.1 Earthing straps, PVC insulated

Permissible symmetrical short-circuit current of earthing straps (PE conductors) Cu (PVC insulated) in relation to a short-circuit duration of 0.04 s; 0.2 s; 0.5 s; 1 s and 5 s.

Permissible symmetrical short-circuit current

Break time of protective device	Cross-section of PE conductor (PVC insulation)				
	4 mm ² (Cu)	10 mm ² (Cu)	16 mm ² (Cu)	25 mm ² (Cu)	35 mm ² (Cu)
0.04 s	2.86 kA	7.15 kA	11.44 kA	17.88 kA	25.03 kA
0.2 s	1.28 kA	3.20 kA	5.12 kA	8.00 kA	11.20 kA
0.5 s	0.81 kA	2.02 kA	3.23 kA	5.05 kA	7.07 kA
1.0 s	0.57 kA	1.43 kA	2.29 kA	3.58 kA	5.01 kA
5.0 s	0.26 kA	0.64 kA	1.02 kA	1.60 kA	2.24 kA

Basis of calculation EN 61 439-1, appendix B (VDE 0660, part 600-1)

$$Sp = \frac{\sqrt{I^2 \cdot t}}{k} \quad I = Sp \cdot k \cdot \sqrt{1/t}$$

I = permissible symmetrical short-circuit current in A

where:

Cross-section of conductor SP = 4, 10, 16, 25, 35 mm²

Break time t = 0.04; 0.2; 0.5; 1; 5 s

Material coefficient k = **143 A** · √s/mm²

4.2 Earthing straps, bare conductors

Permissible symmetrical short-circuit current of earthing straps (PE conductors) Cu (bare conductors) in relation to a short-circuit duration of 0.04 s; 0.2 s; 0.5 s; 1 s and 5 s.

Permissible symmetrical short-circuit current

Break time of protective device	Cross-section of PE conductor (bare)				
	4 mm ² (Cu)	10 mm ² (Cu)	16 mm ² (Cu)	25 mm ² (Cu)	35 mm ² (Cu)
0.04 s	3.52 kA	8.79 kA	14.07 kA	21.99 kA	30.79 kA
0.2 s	1.57 kA	3.93 kA	6.30 kA	9.84 kA	13.78 kA
0.5 s	1.00 kA	2.48 kA	3.97 kA	6.21 kA	8.70 kA
1.0 s	0.70 kA	1.76 kA	2.82 kA	4.40 kA	6.16 kA
5.0 s	0.32 kA	0.79 kA	1.25 kA	1.97 kA	2.76 kA

Basis of calculation EN 61 439-1, appendix B (VDE 0660, part 600-1)

$$Sp = \frac{\sqrt{I^2 \cdot t}}{k} \quad I = Sp \cdot k \cdot \sqrt{1/t}$$

I = permissible symmetrical short-circuit current in A

where:

Cross-section of conductor SP = 4, 10, 16, 25, 35 mm²

Break time t = 0.04; 0.2; 0.5; 1; 5 s

Material coefficient k = **176 A** · √s/mm²

Compact enclosures AX/Small enclosures KX

Test methods and evaluation

5. Test methods and evaluation

Rittal has commissioned one of the largest German test institutes – I²PS in Bonn – to perform an elaborate series of experiments to test the earthing connections of AX compact enclosures and KX small enclosures. These experiments were to investigate both connections between the housing elements and earth conductor terminal points with regard to their proper electrical continuity (in accordance with IEC/DIN EN 62 208) and thermal short-circuit resistance (following IEC/DIN EN 61 439-1). The objective of the tests was to confirm the continuity between the individual housing elements and to obtain values for the short-circuit resistance. Both the surge current resistance and the Joule heat value (I²t value) were determined and documented.

5.1 Test methods

- The test specimens were connected to a heavy current generator via a power transformer and subjected to a short-circuit current over a defined period of time.
- Before and after the short-circuit, the contact resistance was measured using the ammeter-voltmeter method and recorded.
- The surge current was gradually increased until the connection was destroyed or until the permissible contact resistance was exceeded.
- The curve patterns of the current and the voltage were recorded, and the surge current, the symmetrical short-circuit current (r.m.s. value), the short-circuit duration and the Joule integral (I²t value) were determined.
- The condition of the connections before and after the individual phases of the experiment were recorded as photographs.

5.2 Notes of evaluation

The tests were evaluated in that the electrical connection was examined visually and through measurement of the resistance. It must be mentioned that a certain level of crackle remains permissible, provided the electrical connection is not adversely affected and neighbouring inflammable components are not ignited (in accordance with IEC/DIN EN 61 439-1, item 10.11.5.6.2 note 1). It is thus recommended to carry out appropriate individual testing, depending on the specific configuration.

The tests provide a value for the Joule heat (I²t value), which can be converted by the designer to take into account the possible loads arising at the actual point of installation (see IEC/DIN EN 61 439-1). It follows herefrom that the Joule heat I²t is practically constant across the whole range of short durations. This means that the product of the known break time T_k and the permissible thermal short-time current I_{th} must not exceed the specified current carrying capacity (I²t value).

$$I^2 \cdot t = I_{th}^2 \cdot T_k = \text{const.}$$

It should be noted further, that the given values refer only to the tested structural elements and connections.

With regard to the dynamic short-circuit resistance, in particular, it is not possible to specify generally applicable values. When applying the specified values for rated surge current resistance, it must be noted that the layout of the connecting cables and the installations of the enclosure are decisive factors determining the arising current forces.

A large grid of graph paper, consisting of 20 columns and 30 rows of small squares, intended for taking notes.

Rittal – The System.

Faster – better – everywhere.

- Enclosures
- Power Distribution
- Climate Control
- IT Infrastructure
- Software & Services

You can find the contact details of all Rittal companies throughout the world here.



www.rittal.com/contact

XWWW00210EN2308

ENCLOSURES

POWER DISTRIBUTION

CLIMATE CONTROL

IT INFRASTRUCTURE

SOFTWARE & SERVICES



FRIEDHELM LOH GROUP