

Rittal – The System.

Faster – better – everywhere.



White paper – RiMatrix S A strategy for designing standardised data centres



ENCLOSURES

POWER DISTRIBUTION

CLIMATE CONTROL

IT INFRASTRUCTURE

SOFTWARE & SERVICES

FRIEDHELM LOH GROUP



Contents

- List of figures 3
- List of tables 3
- Executive summary 4
- Introduction 5
- Service commitment 7
- Discussion document 9
- Modular system 10
 - Mechanics 12
 - Power backup 13
 - Climate control 14
 - Monitoring 16
 - Safety 17
 - Protective shell 17
- Certification 19
 - Permits for the different components 19
 - Requirements for the physical protective shell 19
 - RiMatrix S (part) certification **Fehler! Textmarke nicht definiert.**
- Process flows 22
 - Consultancy 23
 - Investment costs 23
 - Operating costs 23
 - Personnel costs 24
 - Engineering 24
 - Installation & commissioning 24
 - Service 25
- List of abbreviations 26

List of figures

Figure 1: Customised vs. standardised data centre construction 5
Figure 2: Climate control in the data centre 7
Figure 3: Modular system – schematic diagram 10
Figure 4: Example of a server module 11
Figure 5: Configuration of a server module..... 12
Figure 6: Combining server modules: Double6, Double9..... 13
Figure 7: Climate control for the server module 14
Figure 8: Server module performance diagram 15
Figure 9: Sensor network and monitoring technology 16
Figure 10: An example of the RiMatrix S protective shell..... 17
Figure 11: Process flows 22

List of tables

Table 1: Discussion document..... 9
Table 2: Physical requirements for the “Basic shell – existing asset” solution..... 19
Table 3: Physical requirements for the “Container” solution..... 20
Table 4: Physical requirements for the “Security room” solution 20
Table 5: Cost comparison..... 23

Executive summary

The idea of a modular, standardised data centre is in line with the growing trend towards simple, scalable data centre infrastructures, uniform interfaces and complete automation.

The main trends are:

- Cloud computing
- Mobile data usage
- Global networking
- Big data
- Internet 3.0
- Greater need for security
- Energy efficiency

In order to be able to meet clients' needs for flexible solutions for new business models, complete standardisation is indispensable when designing a data centre.

In this context, the main objectives are:

- Simple planning
- Low investment and operating costs
- Calculable, guaranteed PUE
- Ease of expansion
- Short delivery time
- Future-proofing

This delivers significant benefits over a traditional design. The basis of the modular, standardised data centre is an intelligent system of separate data centre modules with defined parameters and interfaces.

Another key issue is the client interface, which covers everything from top-class consultation, engineering, logistics and installation to service.

This will ensure that clients can be provided with a coordinated, turnkey solution.

Introduction

Data centre operators are faced with a range of requirements, including some with contradictory aspects. This applies both to existing data centres and new ones. These requirements are:

- Performance characteristics and functions
- Security and availability
- Investment, operating and personnel costs
- Efficiency and sustainability
- Modularity, scalability and future-proofing

The focus here is on the end user, i.e. the user who will use the services provided by the data centre. These services are guaranteed by a Service Level Agreement (SLA). It is becoming apparent that the skills required to safeguard the SLAs are overlapping more and more:

- Services and applications
- Virtualisation and appliances
- Servers, storage and switches
- Power supply, power backup and data centre climate control
- Monitoring, control and automation

The convergence of the different skill sets requires a high level of standardisation in every area as well as clearly defined interfaces. Complete modularisation and standardisation will open up new opportunities to achieve efficiencies and generate major simplification in any data centre implementation.

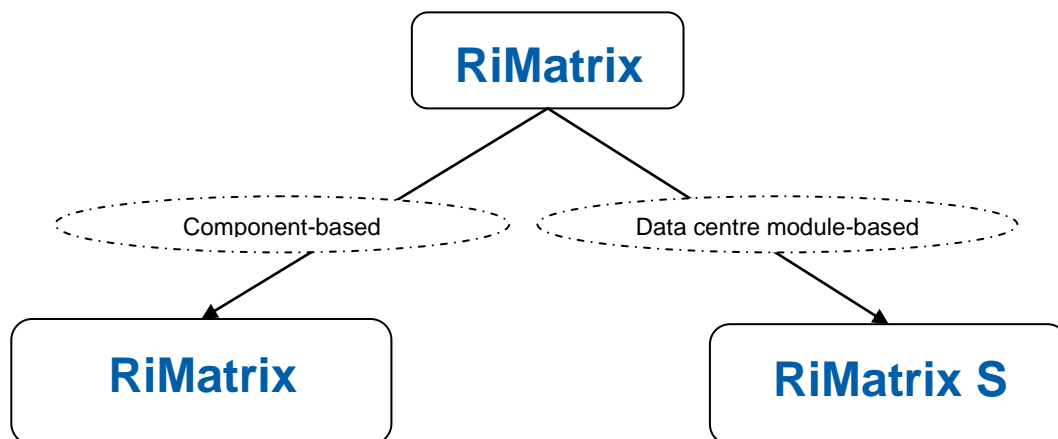

Figure 1: Customised vs. standardised data centre construction

In this context, **RiMatrix** focuses on customised data centre designs:

- Customised data centre
- Tailored data centre solutions
- Continuous development of products

RiMatrix S focuses on standardised data centre designs:

- S = standardised data centre
- Standardised data centre solutions
- Pre-defined data centre modules
- Service commitment linked to client benefits

The technical implementation of this type of solution has to be accompanied by a well-thought-out process chain which is based on the client's expectations. This involves looking very closely at issues such as:

- Advice and consulting
- Drawing up quotations and (ROI) calculations
- Order processing
- Logistics, delivery and commissioning
- Complete documentation
- Acceptance and certification
- Administration
- Add-ons and modifications (MACs)
- Maintenance and replacement parts
- Service and hotline

For end clients, a functioning, coordinated process chain is a crucial requirement if the solution is to be a success.

Service commitment

We shall now describe the benefits of standardising data centre infrastructures. In this context, data centre infrastructures are all of the (sub-) works that are required to ensure that servers, switches and storage systems run smoothly. Two supply channels are critical – power and climate control.

The power supply channel, for instance, comprises these separate components: infeed, mains backup system, automatic transfer switches (ATS), main and sub-distribution, power protection (UPS), sub-distribution to enclosure suites (PDRs) and distribution to the enclosures via socket strips (PDUs). As well as the functional interfaces which ensure the flow of power, the monitoring interfaces that pass the readings and alarm messages to a central management console (DCIM) must also be considered.

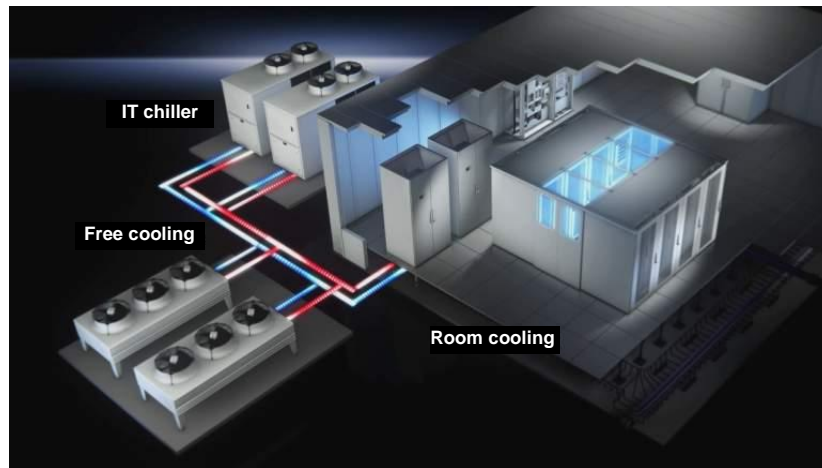

Figure 2: Climate control in the data centre

Similarly, the supply channel for controlling climate in the data centre, which consists of the components for generating, transporting and distributing cool air in the data centre, and removing the waste heat must be considered. The monitoring network which passes parameters and alarm signals to the DCIM console must also be taken into consideration. Furthermore, the mechanical components (server and network enclosures, raised floor, aisle containment systems), security systems (sensor network, early fire detection, fire extinguishing, access protection) and the data centre's shell (container, security room, drywall construction) must be considered.

Complete standardisation of the above components is the basis for a flexibly scalable infrastructure which the data centre administrator can fully monitor from a single data dashboard. The benefits of standardisation include:

- Simplified data centre planning
- Possibility of calculating investment and operating costs
- Low investment, operating and personnel costs
- Ease of upgrade/future-proofing
- Standard solutions at different locations

RiMatrix S – A strategy for designing standardised data centres

- Scalability from small to large installations
- Complete integration into management systems, data centre automation
- Full range of services, replacement part management, maintenance
- Short delivery and launch times
- Tested and documented components, data centre certification
- Simplified administration

The following section will explain how this standardised approach differs from traditional data centre design.

Discussion document

The following discussion document places the key features of the RiMatrix S solution in the context of traditional data centre design.

<u>Traditional data centre design</u>	<u>RiMatrix S</u>
Bespoke planning, customised solution tailored to the client's needs	Pre-planned, pre-configured, proven solution using a standardised approach which considerably shortens the planning phase
Flexibility in component selection	Components tested and aligned with one another, with defined efficiency and performance parameters
Scalability is very granular (pay-as-you-grow)	Option packages to match the client's needs, for example: <ul style="list-style-type: none"> • Measurements per socket • Access protection, ...
Ease of expansion at component level	Expandable at module level
Energy-efficient embedding into the client's infrastructure	Energy-efficient layout with components that integrate perfectly with one another, aligned control Guaranteed PUE based on a verified data sheet
Variety of technologies selected and combined, e.g. in the climate control system	Ease of adaptation into the infrastructure and supply at the client's location
Each data centre must be certified separately	Tested and documented modules which enable simple, full certification at the client's location
The amount of development and implementation work required depends on each individual client's circumstances	Process is far shorter, from planning through to order processing and launch to handover to the client
Bespoke service, tailored to meet the client's needs	Simplified administration, simplified service and replacement part management as a result of the homogeneous infrastructure for a client with more than one data centre

Table 1: Discussion document

Modular system

The data centre modular system, as shown in Figure 3, is based on a 4-level topology for the physical data centre infrastructure.

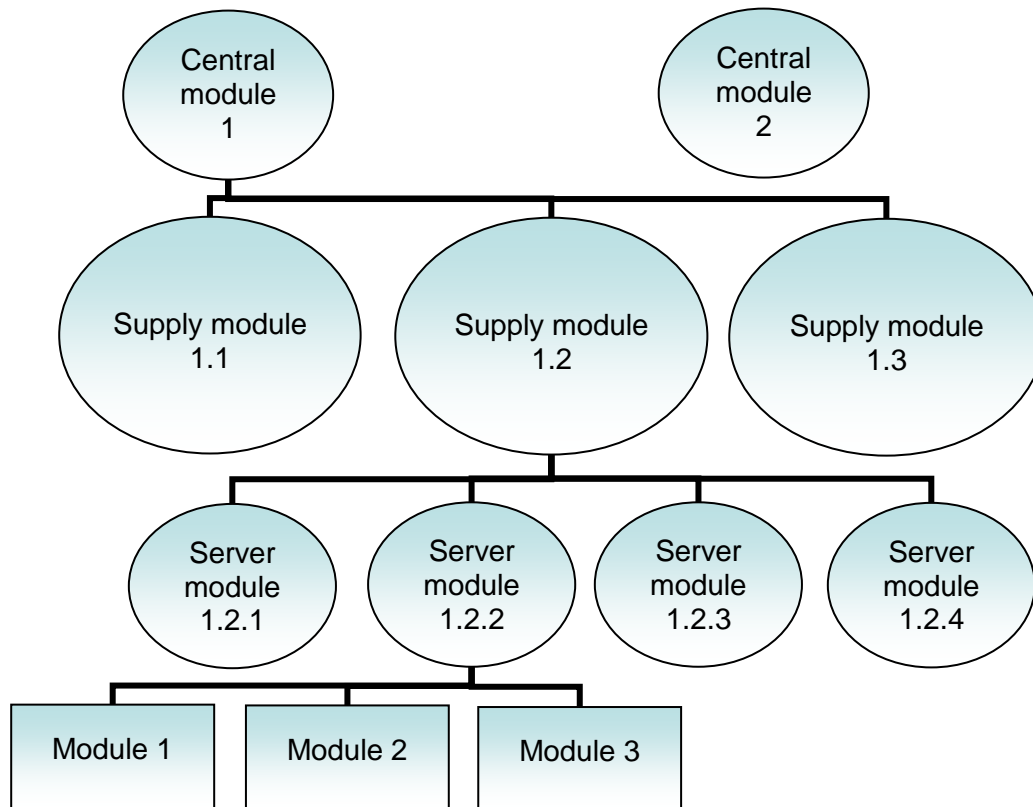

Figure 3: Modular system – schematic diagram

On the first, lowest level are the data centre elements which are used as building blocks to create the basis for the data centre modules on the levels above. These elements are usually standard components which are both inexpensive and quality controlled.

Different types of server module are found on the second level. IT services are provided in these server modules, based on virtualisation techniques in servers/server farms. Figure 4 shows a typical example of a server module.

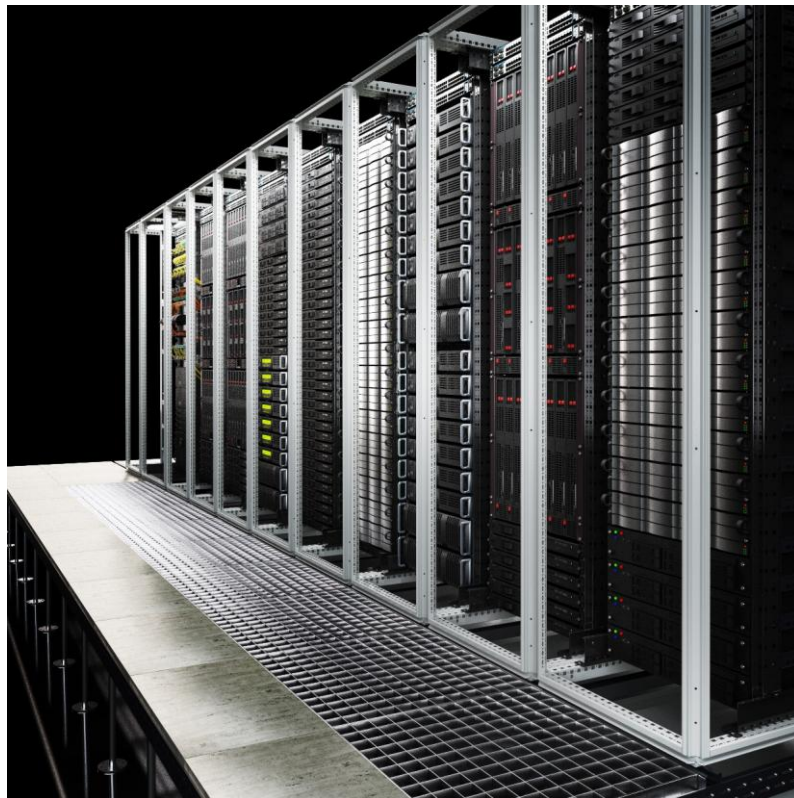

Figure 4: Example of a server module

The third level in the topology outlined above (Figure 3) comprises the supply modules. These may be, for example:

- Cooling modules with integrated free cooler, redundant chillers, pumping stations and controls
- Cooling modules with direct free cooling and mechanical cooling for mixed operations
- Power module with main power supply, automatic transfer switch and mains backup system
- ...

The fourth level is made up of central components which are normally provided by the client, such as:

- Power infeed
- WAN connection, for example, dark fibre
- ...

Different physical shells are offered for the modules outlined at levels 2 and 3, depending on the deployment: aisle containment with drywall construction, containers or security rooms. The sub-sections below will look more closely at the different elements in the module.

Mechanics

When implementing the mechanical solution, a considerable increase in the packing density and concentration on the factors of greatest importance to the users was crucial, namely the server and network components.

In implementing an effective containment system and thus separating the warm and cool areas, the racks no longer require doors. In fact, doors are actually an obstruction, as they inhibit efficient air throughput. Access protection for the IT components, traditionally provided by the enclosure doors, is achieved by access to the individual server modules.

Likewise, no side panels are required, so the mechanical structure can be achieved by frames. The 19" level is sealed off to separate the two air zones, and the space above the frame is also sealed off up to the top of the server module.

To create more space for server and network components, all of the climate control for the module has been implemented in the raised floor.

The configuration of a server module is always the same, as Figure 5 shows.

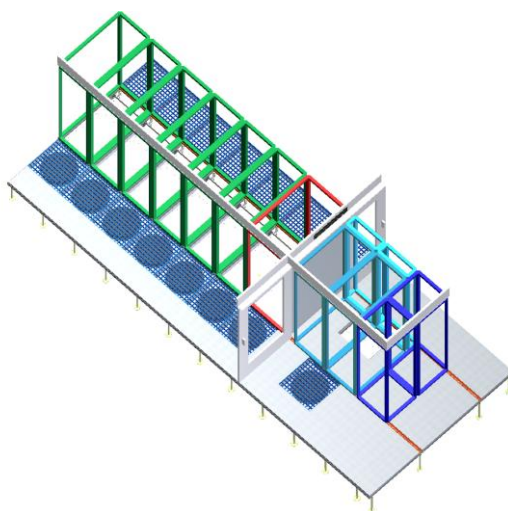

Figure 5: Configuration of a server module

A server module consists of:

- Raised floor with dimensions: 7,000 x 2,750 x 510
- 6 frames for inserting the servers (42 U, 2,000 x 600 x 1,200)
- 1 frame for inserting the network and server technology (42 U, 2,000 x 800 x 1,200)
- Climate control in the raised floor
- Aisle containment to separate warm and cool areas
- UPS system and power distribution
- Early fire detection and optional fire extinguishing

Server modules are provided in various versions, so in large installations, for example, a central power backup may be useful so that there is no need for a UPS in the individual server modules.

A major issue is the ability to combine the individual server modules to create more complex units. For example, they can be arranged mirrored to the server module so that they all have the same cool area. A third module would then, in accordance with the combination principle, lead to a shared hot aisle.

But the server modules can also be arranged serially to create long rows of servers. Figure 6 shows two possible layouts.

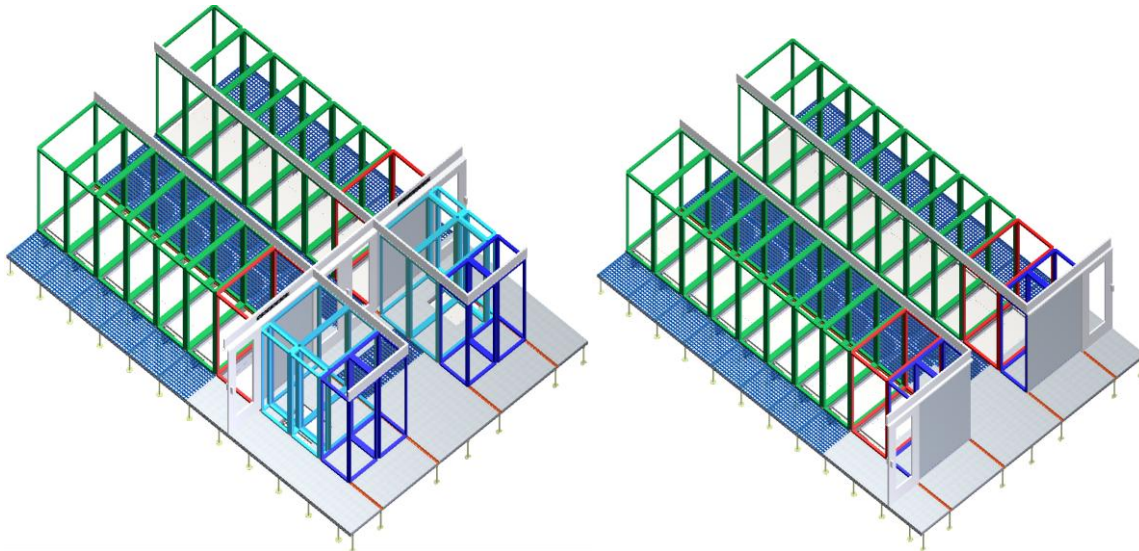

Figure 6: Combining server modules: Double6, Double9

Power backup

The power backup and climate control for a server module need to be closely coordinated, as the electrical energy being fed in is converted to heat which then has to be dissipated. A server module is designed to an output density of 10 kW per server frame, i.e. 60 kW in total. The power distribution in a server module is designed for redundant supply channels (A, B), with the B section being backed up by a UPS system. The UPS is a rack-mounted module and follows the principle of n+1 redundancy, based on the individual slide-in modules which follow a completely parallel architecture.

It is also vital that measurements are taken in the sub-distribution of the power supply channels, in order to:

- determine the PUE
- determine the efficiency of the individual elements, and
- create the bases for energy optimisation.

For this reason, all the power supply parameters need to be passed to the central DCIM software.

Climate control

The climate control for a server module needs to be designed based on maximum efficiency and minimum space requirement. Therefore, climate control devices are placed in the raised floor, as Figure 7 illustrates.



Figure 7: Climate control for the server module

The heat exchangers are placed below the server frames, and the associated fans with the perforated base plate, form a single unit in front of each server frame. A containment system completely separates the cool and warm areas from each other. The air routing is then as follows:

- The fan blows the cold air directly in front of the server level.
- The servers suck in the fresh air and dissipate the warm air through the rear.
- This flows into the raised floor and the heat exchanger cools it once more.
- The fans in the climate control system as well as the servers maintain the flow of air.

A key feature in the climate control system is the n+1 redundancy. Each ZUCS climate control unit is designed for a cooling output of 12 kW. Therefore, 5 units are required for the 60 kW for a Single6 server module. However, 6 units are deployed. This offers two benefits:

- the EC fans work more economically
- if one unit fails, the remaining units are able to deliver the full cooling output.

With the climate control system, particular attention is paid to a cross-disciplinary control system. While traditional components work with autonomous, standalone operating points, in this approach, the optimum operating point for a data centre is set, taking all the components in the cooling chain into account:

- Raised floor climate control for the server modules
- Cooling including pumps and valves

A controller records all the relevant parameters, which are processed by an algorithm, in order to establish the optimum operating point.

Therefore, a server module may well be regarded as a component and sized accordingly. Figure 8 below shows a typical performance diagram.

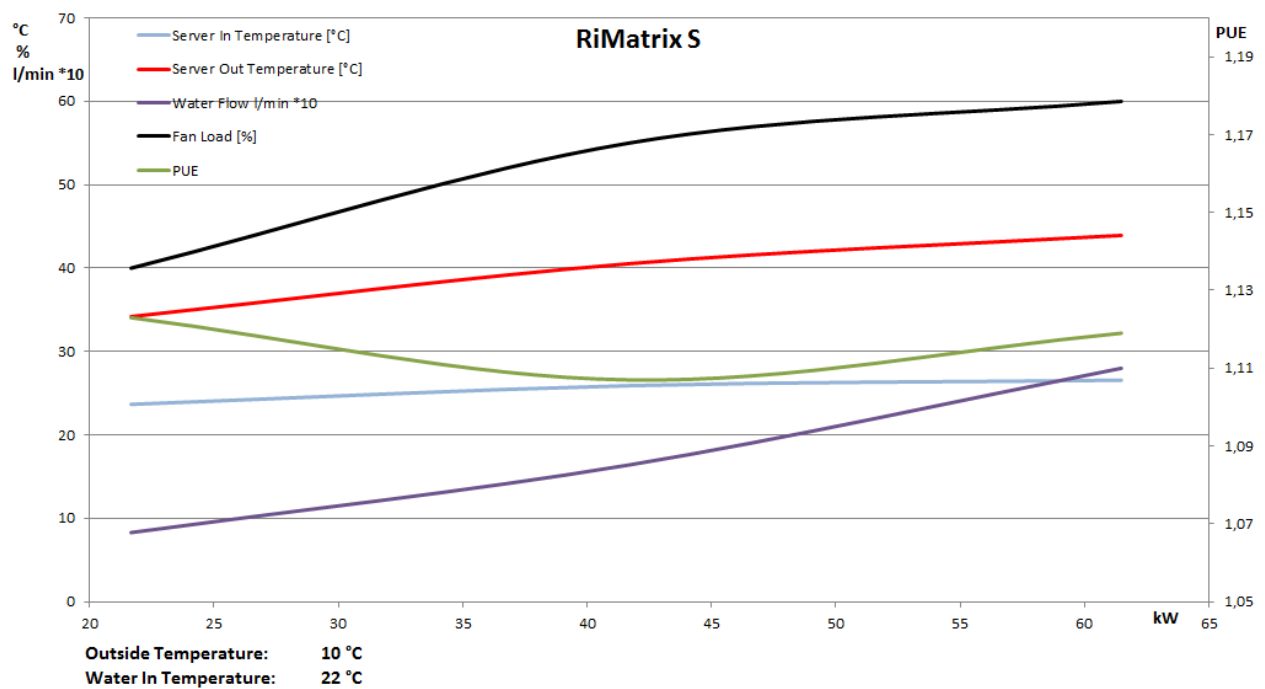

Figure 8: Server module performance diagram

Based on the load, the efficiency (or the consumption values) is shown for given inlet temperatures. This data sheet can be used at the quotation stage to perform an operation cost/ROI analysis. This enables calculation of a planned data centre's consumption – based on location and weather data.

Monitoring

In a server module, a three-level hierarchy is prescribed for monitoring. On the bottom level, there are sensors which pass their information to the controller level.

The controller here should be taken to be the CMC, which takes on local control and monitoring tasks, plus all those components which have an integrated controller (UPSs, chillers, ...).

All the data is gathered, processed and analysed using high-level DCIM software. The DCIM software also provides the following functions/interfaces:

- Connects third party modules (for example PLC, free coolers, pumps, ...)
- Connects to BMS, i.e. building services management
- Connects to IT management systems

Figure 9 below provides an overview of the server network and monitoring technology:

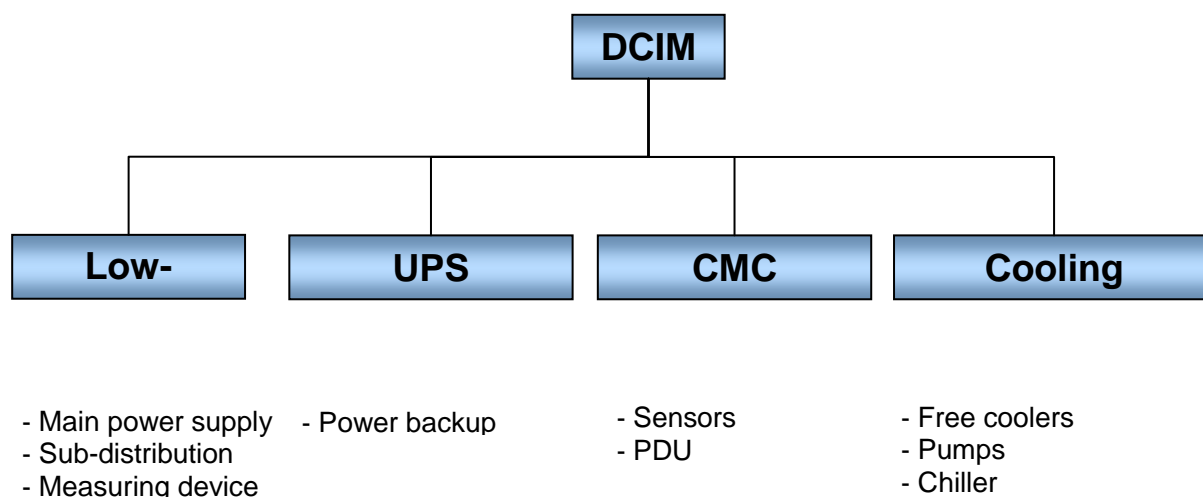

Figure 9: Sensor network and monitoring technology

The DCIM software is used to carry out the following tasks in the modular, standardised data centre:

- Monitor and report all consumption values
- Alarm messages, alarm scenarios, workflows
- User and rights administration for all active components
- Ensure full, cross-work control
- Integrate third party products
- Connect management systems (IT, building services management, BMS)

The standardised, modular data centre structure is the basis for simplified data centre automation/monitoring based on the DCIM software. Standardisation also delivers major benefits when the data centre is distributed across different locations.

Safety

The RiMatrix S will be examined here in terms of its physical security, with the complex issue of the protective shell being dealt with separately in section 3.6.

The following parameters are included in the automatic RiMatrix S security monitoring system:

- Temperature (inside, outside)
- Humidity, leakage
- Vibrations
- Smoke analysis, early fire detection
- Access control
- ...

A fire extinguishing system can be provided as an option for the server module. However, in compliance with the VdS (federation of German property insurance companies), the extinguishing system has to be located outside of the volume to be extinguished – in this case, the server modules. NOVEC is used as the extinguishing gas.

Protective shell

Initially, the RiMatrix S modules are independent of the physical protective shell. The diagram in Figure 10 below illustrates the principle:



Figure 10: An example of the RiMatrix S protective shell

The RiMatrix S can then be implemented in an existing installation in a typical hot aisle/cold aisle situation. Of course, specific security rooms can also be implemented to different standards. Container solutions, which also enable a certain degree of flexibility when

designing the data centre, are also an option. For example, the physical infrastructure can be completely installed in a container, taken live and tested before the container is delivered to the location specified.

Combinations of these protective shells are also possible. For example, the server module can be implemented in a hot aisle/cold aisle solution while the cold air supply module is constructed as a container.

A RiMatrix S System will be delivered with the corresponding housing. The options are:

- Standard Container
- Standard Security Room
- Standard Room

Certification

With the RiMatrix S there is a need to take into account different types of certification and approval, for example:

- Product permits (EC, UL, ...)
- Security issues relating to the physical protective shell
- Client certification
- Certification for the RiMatrix S production process and data sheets

Permits for the different components

To deploy RiMatrix S in an international environment, permits are required for the individual components (building blocks) in compliance with regional and national requirements.

Requirements for the physical protective shell

The table below lists the requirements for the physical protective shell for the RiMatrix S:

	Single6 (60 kW) Standard Room	Double6 (120 kW) Standard Room	Single9 (90 kW) Standard Room	Double9 (180 kW) Standard Room
Model No.:	7998.106	7998.107	7998.406	7998.407
Fire protection	none			
Burglary protection	none			
EMC protection	none			
Acrid gas-tightness	none			
Water and dust-tightness	IP 20			
Battery ventilation	X	X	none	none
Fire alarm system	SIS			
(De-) humidification	none			
Outer door	swing door, single-leaf, left stop, type D panic release, pushbutton/pushbutton, mech. mortise lock, semi-cylinder blocked, door closer mounted outside, clearance dimension 1,090 x 2,070, optional: door monitoring with reed contact + bolt switch contact, optional E lock type 809 ASSA ABLOY, full leaf, with panic type D, 24 mm forend, 65 mm backset			

Table 2: Physical requirements for the “Standard Room” solution

Fire extinguishing system is optional incl. the connecting to a building alarm management.



	Single6 (60 kW) Standard Container	Single9 (90 kW) Standard Container
Model No.:	7998.206	7998.506
Fire protection	EI 30 according EN 1363	
Burglary protection	RC2	RC2
EMC protection	none	
Acrid gas-tightness	none	none
Water and dust-tightness	IP 54	IP 54
Battery ventilation	X	none
Fire alarm system	SIS	
(De-) humidification	optional	
Outer door	F30 in accordance with DIN 4102, swing door, single-leaf, left stop, RC2, smoke-proof in accordance with EN 1634, panic release, pushbutton/knob, mech. mortise lock, semi-cylinder blocked, door closer mounted inside, IP 56, clearance dimension 935 x 2,070, optional: door monitoring with reed contact + bolt switch contact, optional E lock type 809 ASSA ABLOY, full leaf, with panic type D, 24 mm forend, 65 mm backset	

Table 3: Physical requirements for the “Standard Container” solution

	Single6 (60 kW) Standard Security Room	Double6 (120 kW) Standard Security Room	Single9 (90 kW) Standard Security Room	Double9 (180 kW) Standard Security Room
Model No.:	7998.306	7998.307	7998.606	7998.607
Fire protection	EI 90 in accordance with EN 1363			
Burglary protection	RC2			
EMC protection	screening attenuation readings provided			
Acrid gas-tightness	Acc. EN 1634-3		Acc. EN 1634-3	
Water and dust-tightness	IP 54/is to be evaluated		IP 56	
Battery ventilation	X		none	
Fire alarm system	SIS			
(De-) humidification	none			
Outer door	F90 in accordance with DIN 4102, swing door, single-leaf, left stop, RC2, smoke-proof in accordance with EN 1634, panic release, pushbutton/pushbutton, mech. mortise lock, semi-cylinder blocked, door closer mounted outside, IP 56, clearance dimension 1,030 x 2,030, optional: door monitoring with reed contact + bolt switch contact, optional E lock type 809 ASSA ABLOY, full leaf, with panic type D, 24 mm forend, 65 mm backset			

Table 4: Physical requirements for the “Standard Security Room” solution

Data Centre certification

Many mechanical engineers aim at certifying their data centres. The reasons are complying a standard of safety in own interests as well as aim significant savings at insurance companies.

To certify an individual data centre can take up to a few weeks because the individual components have to be tested in detail.

Also the RiMatrix S modules have to be tested and certified individually. In contrast to the customised data centres the RiMatrix S modules are already tested in the laboratory and documented.

This simplifies the complete certification of the data centre significantly as the data centre consist of one or more modules which are all constructed identically.

Documents which are already approved for a module can be taken over for the remaining modules.

Process flows

Based on the value added chain (Figure 11), the main process flows from the client's perspective should be shown.

① Implementation of client projects

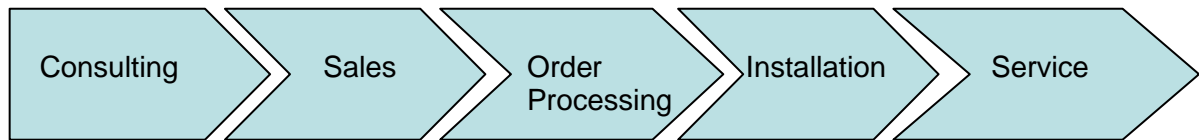

② Production and logistics

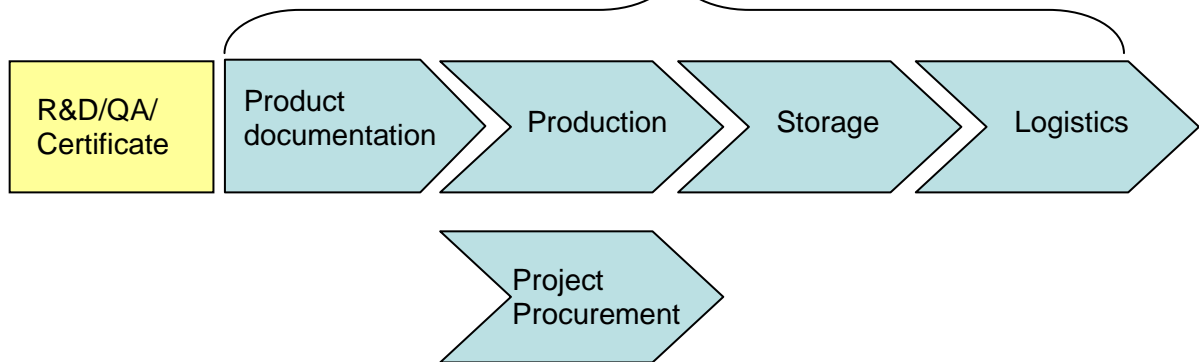

Figure 11: Process flows

The modular, standardised data centre also delivers a number of benefits throughout the client process chain. The main project steps are:

- Consultancy
- Project planning, order processing
- Delivery, logistics
- Installation, commissioning, acceptance
- Service

The following sub-sections explain the different process steps in detail.

Consultancy

In the modular, standardised data centre approach, consultancy is a key factor from the end client's perspective, as it is always compared with the traditional, customised design. In addition to the technical issues, the anticipated costs are particularly important, and three dimensions need to be considered:

- Investment costs
- Operating costs
- Personnel costs

Investment costs

The various elements in a RiMatrix S need to be compared with the traditional design taking into account the redundancies:

	RiMatrix S	Traditional design
Enclosures (servers, network)	Frames	Enclosures
Raised floor, containment	Raised floor, containment	Raised floor, containment
Climate control module	Redundant raised floor climate control	3 x 30 kW CRAC devices (cold water mode)
Power backup	60 kW UPS (n+1 redundancy)	60 kW (n+1 redundancy)
Power distribution	PDR, PDU	PDR, PDU
Monitoring, control	CMC, RiZone	Controller, DCIM

Table 5: Cost comparison

Operating costs

The likely cost of operating a planned data centre based on the RiMatrix S can be calculated at the quotation stage. When doing so, the following parameters have to be considered:

- Location of the data centre (annual climate cycle)
- Temperature progression, server air injection temperature
- Cold air generation integrated into the high-level control of the elements
- The client's load profile

Every RiMatrix S solution is based on the same standardised modules whose parameters and sets of characteristics are known. At a given load and defined temperature progression, the efficiency can be calculated if the exterior temperature and therefore the cost of generating cold air is known.

Personnel costs

On the personnel side, savings are primarily derived as a result of the complete automation of a standardised infrastructure. Bringing all the operating parameters together onto a single dashboard makes the workload considerably easier.

Engineering

Here, the term “engineering” refers to the configuration/arrangement of the RiMatrix S modules, taking into account their integration into the client’s specific infrastructure.

The client’s requirements for a particular data centre output can be mapped to a whole number multiple of server modules, with location parameters also being used when making the configuration. These parameters, in particular, have a major impact on the energy costs required to generate the cold air.

The server modules need to be integrated into the power and climate control supply channels. Here, there are various options:

- Power and climate control are provided by the client, e.g. by a central UPS/mains backup system or in-house cooling system
- Project-specific connection to power supply and cool air supply
- Provided by power and cooling modules as part of the RiMatrix S and possibly supplied by a partner

The aim is to provide the client with a complete, fully functional data centre infrastructure.

Installation & commissioning

Every RiMatrix S solution is based on standardised, pre-developed modules which, depending on their characteristics, can be part-finished, part-tested and kept in storage. This allows for a significant reduction in the time between the order being “clarified” and the project being “taken live”. Two cases are to be considered:

- The client is supplied with a full, pre-tested server module which comes with a container as the protective shell, therefore acting as the transport packaging.
- In the second case, the RiMatrix S server module is built in the relevant physical shell in the client’s own environment. Here it is crucial that it is delivered in the correct logical sequence, in order to ensure it is built in the shortest possible time with no delays.

In both cases, the commissioning and final acceptance take place on the client’s premises. Certification (under the BSI, TSI) may then follow.

Service

Particularly when more than one location is involved, a standardised IT infrastructure offers both the client and the manufacturer's service department a number of benefits:

- All the server module installations are based on the same components.
- The system connections are always the same.
- The software versions and patch levels of the controller are known.
- The software versions and patch levels of the DCIM are known.
- The integration into the client's infrastructures is known and documented.
- The supply modules are always the same and therefore documented.

The fact that all the elements are fully networked and brought together in the DCIM software enables online remote diagnosis so that service processes are also time-optimised in the event of a failure.

List of abbreviations

ATS	Automatic transfer switch
BMS	Building Management Solution
BSI	German Federal Office for Information Security
CE	Designation in accordance with European Union Regulation 765/2008
CMC	Computer Multi Control (a data centre's sensor network system)
CRAC	Computer Room Air Conditioner
DCIM	Data Centre Infrastructure Management
DIN	German industry norm
EMC	Electromagnetic compatibility
R&D	Research and Development
BSM	Building services management
IP xy	Protection type, International Protection (xy ~ code)
LER	Rittal class LER security room
MBS	Mains backup system
LVMD	Low-voltage main distributor
PDR	Power Distribution Rack
PDU	Power Distribution Unit
PUE	Power Usage Effectiveness
QA	Quality assurance
SIS	Smoke Intake System, early fire detection
RiMatrix S	Modular, standardised data centre
ROI	Return on Investment
DC	Data centre
SLA	Service Level Agreement
PLC	Programmable Logical Controller
TSI	Trusted Site Infrastructure
UL	Underwriters Laboratories – security certificates
UPS	Uninterruptible Power Supply
VdS	Federation of German property insurance companies
RC/RC2	Certificate for a resistance class/burglar protection
ZUCS	Zero U-Space Cooling System

Rittal – The System

Faster – better – worldwide

- Enclosures
- Power Distribution
- Climate Control
- IT Infrastructure
- Software & Services

RITTAL GmbH & Co. KG
Auf dem Stützelberg D-35726 Herborn
Phone +49(0)2772 505-0 Fax +49(0)2772 505-2319
E-mail: info@rittal.de • www.rittal.de • www.rimatrix5.de

ENCLOSURES

POWER DISTRIBUTION

CLIMATE CONTROL

IT INFRASTRUCTURE

SOFTWARE & SERVICES

FRIEDHELM LOH GROUP

