

www.rittal.com

800-CON module

Transfer module (set of 2) for the REM 801

User manual and technical data





800-CON transfer module (set of 2) for the REM 801

Doc. no. D-0000-00003420-00

Date: 03/2024

The German version is the original edition of the documentation

Subject to technical alterations.

The contents of our documentation have been compiled with great care and reflect the current state of the information available to us. Nonetheless, we wish to point out that updates of this document are not always possible at the same time as technical refinements are implemented in our products.

Please see our website under www.rittal.com for the current version.

TABLE OF CONTENTS

1. Information on the devices and the user manual	6
1.1 Disclaimer.....	6
1.2 Copyright notice.....	6
1.3 Technical changes.....	6
1.4 About this user manual.....	6
1.5 Defective device/disposal.....	7
2. Safety	8
2.1 Display of warning notices and safety information.....	8
2.2 Hazard levels.....	8
2.3 Product safety.....	8
2.4 Hazards when handling the device, components and modules.....	9
2.5 Electrically qualified personnel.....	10
2.6 Warranty in the event of damage.....	10
2.7 Safety information for handling current transformers.....	10
3. Product description	12
3.1 800-CON module (set of 2).....	12
3.2 Incoming goods inspection.....	12
3.3 Intended use.....	13
3.4 Overview of module functions.....	13
3.5 Declaration of conformity.....	13
3.6 FCC Declaration of Conformity.....	13
3.7 Protective device/transformer.....	13
3.8 Scope of delivery, 800-CON transfer module (set of 2).....	14
3.9 Operating concept.....	14
4. Mounting	16
4.1 Mounting of the 1st transfer module with output bus connector.....	16
4.2 Mounting the 2nd transfer module with input bus connector.....	18
4.3 Connection of device and module series with the 800-CON transfer modules.....	20
5. Connections/controls	22
5.1 Connections/controls on 800-CON module.....	22
5.2 Marking of the 800-CON module - rating plate.....	23

6. Installation	24
6.1 Data transfer with 800-CON module.....	24
6.2 Data cable for connecting the 800-CON transfer modules.....	25
7. Operation and button function of the meter and module topology	25
8. Device views - 800-CON transfer module	26
9. Technical data	27
10. Dismounting	28
11. Service and maintenance	29
11.1 Repair.....	29
11.2 Service.....	29
11.3 Device adjustment.....	29
11.4 Calibration interval.....	29
11.5 Firmware update.....	29
11.6 Procedure in the event of a malfunction.....	29
11.7 Resetting the module to the standard factory settings.....	29

1. Information on the devices and the user manual

1.1 Disclaimer

Compliance with the usage information for the devices (modules/components) is a prerequisite for safe operation and attaining the stated performance characteristics and product features.

RITTAL GmbH & Co. KG assumes no liability for bodily injury, material damage or financial losses which result from disregard of the usage information.

Ensure that the usage information for the products is legible and accessible.

1.2 Copyright notice

© 2023 - RITTAL GmbH & Co. KG - Herborn. All rights reserved.

Any reproduction, processing, distribution or other use of this usage information, in whole or in part, is prohibited.

All trademarks and the rights arising from them are the property of the respective owners of these rights.

1.3 Technical changes

- Make sure that your device (modules/components) matches the user manual.
- This user manual is valid for the 800-CON module (set of 2). Separate validities and distinctions are marked.
- First make sure you have read and understood the usage information accompanying the product.
- Keep the usage information associated with the product available for the entire service life and pass it on to any possible subsequent users.
- Find out about device revisions and the associated modifications of the usage information associated with your product at our website.

1.4 About this user manual

If you have questions, suggestions or ideas for improvement of the user manual, please let us know via email at: (info@rittal.com).

INFORMATION

This user manual describes the 800-CON module (set of 2) for the REM 801 basic device and provides information about the operation of the device and modules.

Also consult the additional usage information relevant for this user manual, such as:

- the installation instructions.
- the data sheet.
- the "Safety information" supplement.
- the supplement on mounting the modules.
- the usage information on the basic device and the integrated modules of your meter and module topology.

INFORMATION

Our usage information uses the grammatical masculine form in a gender-neutral sense! This form always refers equally to women, men and diverse. In order to make the texts more readable, distinctions are not made. We ask for your understanding for these simplifications.

1.1 Defective device/disposal

Before sending **defective devices, modules or components** back to the manufacturer for testing:

- Contact the manufacturer's Support department.
- Send devices, modules or components complete with all accessories.
- When doing so, please bear the terms for transportation in mind.

INFORMATION

Please return defective or damaged devices, modules or components to RITTAL GmbH & Co. KG in accordance with the shipping instructions for air or road freight (complete with accessories). Observe special regulations for devices with built-in batteries or rechargeable batteries!

Do not attempt to open or repair the device (the module, the component) on your own because otherwise all warranty claims become invalid!

For the **disposal** of the device (the module, the component), please observe national regulations! Dispose of individual parts, as applicable, depending on their composition and existing country-specific regulations, e.g. as

- Electronic waste,
- Batteries and rechargeable batteries.
- Plastics.
- Metals.

Engage a certified disposal company to handle scrapping as needed.

Information on "Service and maintenance" of your device can be found in chapter 11 on page 29.

2. Safety

The chapter on Safety contains information which must be observed to ensure your personal safety and avoid material damage.

2.1 Display of warning notices and safety information

The warning notices shown below

- are found throughout the usage information.
- can be found on the devices themselves.
- indicate potential risks and hazards,
- underscore aspects of the information provided that clarifies or simplifies procedures.



This additional symbol on the device (module/component) itself indicates an electrical hazard that can lead to severe injury or death.



This general warning symbol draws attention to a possible risk of injury. Be certain to observe all of the information listed under this symbol in order to avoid possible injury or even death.



2.2 Hazard levels

Warning and safety information is marked by a warning symbol, and the hazard levels are shown as follows, depending on the degree of hazard:

DANGER

Warns of an imminent danger which, if not avoided, results in serious or fatal injury.

WARNING

Warns of a potentially hazardous situation which, if not avoided, could result in serious injury or death.

CAUTION

Warns of an immediately hazardous situation which, if not avoided, can result in minor or moderate injury.

ATTENTION

Warns of an immediately hazardous situation which, if not avoided, can result in material or environmental damage.

INFORMATION

Indicates procedures in which there is **no** hazard of personal injury or material damage.

2.3 Product safety

The devices, components and modules reflect current engineering practice and accepted safety standards, but hazards can arise nonetheless.

Observe the safety regulations and warning notices. If notices are disregarded, this can lead to personal injury and/or damage to the product.

Every type of tampering with or use of the devices and the modules,

- which goes beyond the mechanical, electrical or other operating limits can lead to personal injury and/or damage to the product;
- constitutes “misuse” and/or “negligence” under the product’s warranty and thus voids the warranty for any possible resulting damage.

Read and understand the user manual and the usage information on the basic device before installing, operating, maintaining and using the devices, components and modules.

Only operate the devices, components and modules when they are in perfect condition and in compliance with this user manual and the usage information that is included. Send defective devices, components or modules back to the manufacturer in compliance with proper transport conditions.

Retain the user manual throughout the service life of your product and keep it at hand for consultation.

When using the device, component or module, also observe the legal and safety regulations for your system that are applicable for the respective use case.

2.4 Hazards when handling the device, components and modules

When operating electric devices, components or modules, it is unavoidable for certain parts of these devices to conduct hazardous voltage. Consequently, severe bodily injury or material damage can occur if they are not handled properly.

Therefore, when handling our devices, components, or modules, always observe the following:

- do not exceed the limit values specified in the user manual and on the rating plate! This must also be observed during testing and commissioning!
- Take note of the safety and warning notices in all usage information that belongs to the device, components or modules!

WARNING

Disregarding the connection conditions of the Rittal measurement devices, modules or components can lead to injuries or even death or to material damage!

- Do not use Rittal meters, modules or components for critical switching, control or protection applications where the safety of persons and property depends on this function.
- Do not carry out switching operations with the Rittal measurement devices, modules or components without prior inspection by your system manager with specialist knowledge! In particular, the safety of persons, material assets and the applicable standards must be taken into account!

WARNING

Risk of injury due to electrical current and voltage! Severe bodily injury or death can result! Therefore please abide by the following:

- **Do not touch bare, stripped wires or device inputs that are dangerous to touch on the devices, components and modules.**
- **Switch off your installation before commencing work! Secure it against being switched on! Check to be sure it is de-energized! Ground and short circuit! Cover or block off adjacent live parts!**
- **During operation and troubleshooting (especially with DIN rail devices), check the environment for dangerous voltages and switch these off if necessary!**
- **Wear protective clothing and protective equipment in accordance with applicable guidelines when working on electrical systems!**
- **Before making connections, ground the device / component / module by means of the ground wire connection, if present!**
- **Do not touch bare or stripped leads that are energized! Equip stranded conductors with wire ferrules!**
- **Hazardous voltages can be present in all circuitry parts that are connected to the power supply.**
- **Protect wires, cables and devices with a suitable line circuit breaker/fuse!**
- **Never switch off, remove or tamper with safety devices!**
- **There can still be hazardous voltages present in the device or in the component (module) even after it has been disconnected from the supply voltage (capacitor storage).**
- **Do not operate equipment with current transformer circuits when open.**
- **Only connect screw terminals with the same number of poles and design!**
- **Do not exceed the limit values specified in the user manual and on the rating plate! This must also be observed during testing and commissioning.**
- **Take note of the safety and warning notices in the usage information that belongs to the device, components or modules!**

2.5 Electrically qualified personnel

To avoid bodily injury and material damage, only electrically qualified personnel are permitted to work on the devices and their components, modules, assemblies, systems and current circuits who have knowledge of:

- The national and international accident prevention regulations.
- Safety technology standards.
- Installation, commissioning, operation, disconnection, grounding and marking of electrical equipment.
- the requirements concerning personal protective equipment.

Electrically qualified persons within the scope of the technical safety information of all usage information associated with the device and its components (modules) are persons who can furnish proof of qualification as an electrically skilled person.



WARNING

Warning against unauthorized manipulation or improper use of the device or its components (modules)!

Opening, dismantling or unauthorized manipulation of the device and its components (modules) which goes beyond the mechanical, electrical or other operating limits indicated can lead to material damage or injury, up to and including death.

- **Only electrically qualified personnel are permitted to work on the devices and their components (modules), assemblies, systems and current circuits.**
- **Always use your device or component (module) only in the manner described in the associated documentation.**
- **If there is discernible damage, send the device or the component (module) back to the manufacturer!**

2.6 Warranty in the event of damage

Any unauthorized tampering with or use of the device, component or module constitutes “misuse” and/or “negligence” under the product’s warranty and thus voids the warranty for any possible resulting damage. Note in this regard Sect. “3.3 Intended use” on p. 13.

2.7 Safety information for handling current transformers

The field of transformer technology groups the totality of all devices that perform the function of a current, voltage or measuring transformer together as sensors.

The usage information for our devices, modules and components contains the terms **current transformer, voltage transformer or transformer**, which are representative for **sensors**.

A further distinction is made by the terms **CT (current transformer)** and **LP-CT (low-power current transformer)**:

The term “current transformer” is used for special transformers for the primary-proportional conversion of currents of large magnitudes to directly measurable, smaller current values.

In contrast, the term “LP current transformer” (low-power current transformer) is used for special transformers for the primary-proportional conversion of currents of large magnitudes to directly measurable, smaller voltage values (low power).

Current transformers and LP current transformers provide safe galvanic isolation between the primary circuit and the measurement circuit due to their design and their physical operating principle. For Rittal measurement devices, modules and components, use only **“transformers for measuring purposes”** that are suitable for the energy monitoring of your system! Observe the corresponding warning notices!

Basic devices use only the term **“current transformer”** in the display for the configuration of both **current transformers and LP current transformers**.

**CAUTION**

Risk of injury or damage to the meter due to high measured currents(measured voltages at the connections of the current transformers!

High measurement currents can cause temperatures of up to 80 °C (176 °F) on the connections of the current transformers

- **Use wiring that is designed for an operating temperature of at least 80 °C (176 °F)!**
- **Only use current transformers with basic insulation to IEC 61010-1:2010!**
- **Make sure that screw terminals for the current transformer connection on the device are adequately tightened!**
- **Comply with the information and provisions in the documentation of your current transformers!**
- **Ground connections present on the secondary windings of the current transformers must be connected to ground!**
- **The current transformers can be hot even after the power supply has been switched off. Allow the connections of the current transformers and the connecting cables to cool down before touching them!**

**CAUTION**

Risk of injury or damage to the basic device (module) and/or your system due to a short circuit!

Inadequate insulation at the current measuring inputs of the modules with respect to the supply circuits of the basic device can cause dangerous voltages at the measuring input or damage to your device (module)/ system.

- **Ensure reinforced or double insulation with respect to the supply circuits!**

3. Product description

3.1 800-CON module (set of 2)

The module set, consisting of 2 transfer modules, transmits the JanBus communication of a basic device via a data line (for type, see Technical data) to remote measurement points.

The transfer modules (set of 2), allow the implementation of measurement device and module topologies (e.g. REM 801 with modules 800-CT8-A) with flexible arrangement of your DIN rails (for types, see Sect. "9. Technical data" on p. 27) in the switchboard cabinet or small distribution board.



Fig.: 800-CON module (transfer module, output / input)

i INFORMATION

When setting up your meter and module topology, note the following:

- **Both modules in the set of 2 are suitable as input or output modules!**
- The scope of delivery for the transfer modules includes the appropriate bus connector (JanBus interface).
- The maximum bus length (JanBus - proprietary) for setting up measurement device and module topologies can be found in Sect. "9. Technical data" on p. 27.
- In addition to the usage information for the transfer modules (set of 2), also observe all usage information for other modules and components integrated in the JanBus topology, especially that of your basic device!

3.2 Incoming goods inspection

The prerequisites for trouble-free and safe operation of the modules include proper transport, storage, setup and assembly, as well as proper operation and maintenance.

Exercise due caution when unpacking and packing the device, do not use force and only use suitable tools.

Check the following:

- The modules by performing a visual inspection to ensure flawless mechanical condition.
- The scope of delivery (see Sect. "3.8 Scope of delivery, 800-CON transfer module (set of 2)" on p. 14) for completeness before beginning with assembly and installation.

If it must be assumed that safe operation of your basic device with module is not possible:

1. **Switch off the power to your system (your device)!**
2. **Secure it against being switched back on!**
3. **Check to be sure it is de-energized!**
4. **Ground and short circuit the system (device)!**
5. **Cover or block off adjacent live parts!**

Safe operation is impossible, if, for example, the basic device with module:

- has visible damage,
- no longer functions despite an intact power supply,
- was subjected to extended periods of unfavorable conditions (e.g. storage outside of the permissible climate thresholds without adjustment to the room climate, condensation, etc.) or transport stress (e.g. falling from an elevated position, even without visible external damage, etc.).

ATTENTION

Improper handling may cause damage to the module and result in material damage!

The contacts of the bus connectors (Janbus interface) can bend or break off and destroy the bus connector.

- **Never touch or manipulate the contacts of the bus connector!**
- **Never force the bus connector into the module! Please note Sect. "4. Mounting" on p. 16 in this regard.**
- **When handling, transporting and storing the module, protect the contacts of the bus connector!**

3.3 Intended use

The modules/components

- Are only for use in the industrial sector.
- Are intended as expansion or transfer modules for the REM 801 basic device in switchboard cabinets and small distribution boards.
- Must only be mounted with basic devices that are disconnected from the power supply (see Sect. "4. Mounting" on p. 16).

INFORMATION

More information on certain functions of the basic device with modules can be found in the usage information of the basic device.

The basic device and the modules are **not** designed for installation:

- In vehicles! Use of the basic device with modules in non-stationary equipment is considered an exceptional environmental condition and is only permissible by special agreement.
- In environments with harmful oils, acids, gases, vapors, dusts, radiation, etc.
- In potentially explosive environments.

3.4 Overview of module functions

Functions of the 800-CON module:

- JanBus interface module (proprietary) for the communication of REM 801 basic devices via bus connector and twisted pair, shielded data cable (1:1 connection via shield clamps) in a module topology (see Sect. "6. Installation" on p. 24).
- The maximum bus length (JanBus proprietary) in a meter and module topology can be found in Sect. "9. Technical data" on p. 27!

3.5 Declaration of conformity

The laws, standards and directives applied by RITTAL GmbH & Co. KG for the devices can be found in the declarations of conformity at www.rittal.com.

3.6 FCC Declaration of Conformity



The device:

- complies with Part 15 of the FCC Rules for Class B digital devices (limits to protect against harmful interference in a residential installation).
- generates, uses and can radiate high-frequency energy
- can cause harmful interference to radio communications if not installed and used properly. There is no guarantee that interference will not occur in a particular installation.

If there is radio or television reception interference, which can be determined by turning the device on and off, proceed as follows:

- Align or reposition the receiving antenna.
- Increase the distance between the device and the radio/television receiver.
- Connect the device and the radio/television receiver in different circuits.
- if necessary, contact Rittal support or a radio/television technician.

Code of Federal Regulations, Title 47, Part 15, Subpart B - Unintentional Radiators.

3.7 Protective device/transformer

It is not permitted to use the outputs of Rittal measurement devices, components and modules for switching protective devices or protective relays! Use only "Current transformers for measuring purposes" for Rittal measurement devices, components and modules!

3.8 Scope of delivery, 800-CON transfer module (set of 2)

Quantity	Part. no.	Designation
1	9393230	800-CON module - Transfer module (set of 2)
		- Installation instructions (DE/EN)
		- "Safety information" supplement
		- "Mounting" supplement
		- Accessory pack

Tab. Scope of delivery, 800-CON transfer module

i INFORMATION

- The modules are supplied with the necessary terminals, end brackets and bus connectors (JanBus interface) for connection to the basic device or other modules (accessory pack).
- All supplied options and design variants are described on the delivery note.

3.9 Operating concept

The 800-CON (set of 2) expansion and transfer module is used for connecting remote measurement points as previously described in Sect. "3.1 800-CON module (set of 2)" on p. 12.

The modules can be used to realize measurement device and module topologies with a flexible arrangement of the DIN rails. To operate the devices, components and modules integrated in your measurement device and module topology, please refer to the respective additional usage information.

i INFORMATION

Please refer to the user manual of the REM 801 basic device for the operation, configuration and readout of expansion modules.

This user manual describes the modules and provides information on the operation of the modules via the basic device (REM 801).

A list of parameters and Modbus addresses with data on your basic device with module is available for you as a download on our website.

4. Mounting

⚠ CAUTION

Disregard of the installation instructions may cause property damage or personal injury!
Disregard of the assembly instructions may cause damage to your basic device with module or destroy it and/or may also result in personal injury.

- In addition to the installation instructions for your module, also observe the installation instructions for your basic device, in particular the safety and warning information.
- Before installing modules
 - Disconnect the supply of power to the system!
 - Secure it against being switched on!
 - Check to be sure it is de-energized!
 - Ground and short circuit!
 - Cover or block off adjacent live parts!
- Provide adequate air circulation in your installation environment and cooling, as needed, when the ambient temperatures are high.
- Return defective modules to Rittal GmbH & Co. KG in accordance with the shipping instructions for air or road freight (complete with accessories).
- All usage information is also available as a download at our website.

i INFORMATION

- The following module assembly sequence must be observed!
- Always mount the components of your JanBus system starting from the output bus connector to the input bus connector. This will avoid an incorrect connection of remote JanBus systems! Cf. Sect. "6.1 Data transfer with 800-CON module" on p. 24.
- Plan for sufficient space in your installation environment, including for the bending radius of the data cable.
- Use end brackets and shield clamps with strain relief to set up your measurement device and module topology on a suitable DIN rail (for DIN rail types, see Sect. "9. Technical data" on p. 27).

System limits:

- The maximum bus length (JanBus - proprietary) for setting up measurement device and module topologies can be found in Sect. "9. Technical data" on p. 27.
- Before mounting, please check the number of suitable modules for your measurement device and module topology based on the respective usage information. Do not exceed the maximum number of module slots of the basic device! The 800-CON transfer modules (set of 2) do not occupy a slot!
- For recommended data cables, refer to Sect. "6.2 Data cable for connecting the 800-CON transfer modules" on p. 25.

Please note before installing the module:

The scope of delivery of the 800-CON transfer modules (set of 2) includes an input and an output bus connector, so that each transfer module can be used with the corresponding bus connector at the output or input of a series of measurement devices and modules.

Output bus connector 1TE

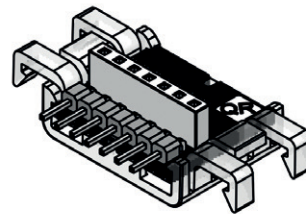

Fig.: Output bus connector for the 800-CON transfer module at the output of a series of measurement devices and modules.

Input bus connector 1TE

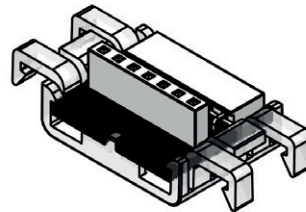

Fig.: Input bus connector for the 800-CON transfer module at the input of a series of measurement devices and modules.

4.1 Mounting of the 1st transfer module with output bus connector

While observing the mounting instructions for your basic device or the connected module (e.g. check the bus connector mounting!), mount the 800-CON transfer module with output bus connector when the system is disconnected from the power supply as follows:

ATTENTION

Improper handling may cause damage to the module and result in material damage!

The contacts of the bus connectors (Janbus interface) can bend or break off and destroy the bus connector.

- Never touch or manipulate the contacts of the bus connector!
- Never force the bus connector into the module!
- When handling, transporting and storing the module, protect the contacts of the bus connector!

1. Press in the bottom bolts on the rear of the module.

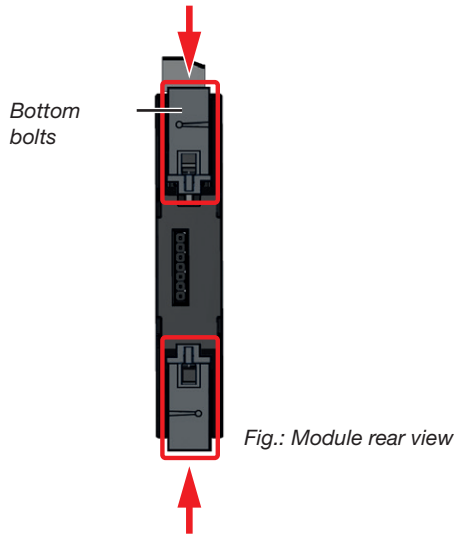

2. If not already done, plug the output bus connector (JanBus interface) included in the scope of delivery into the sockets on the back of the module.

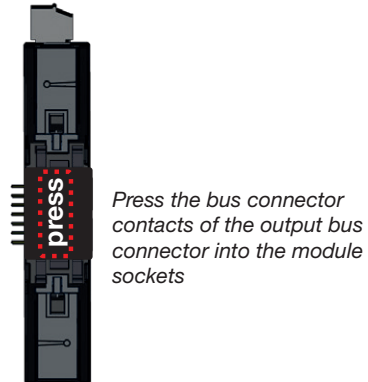
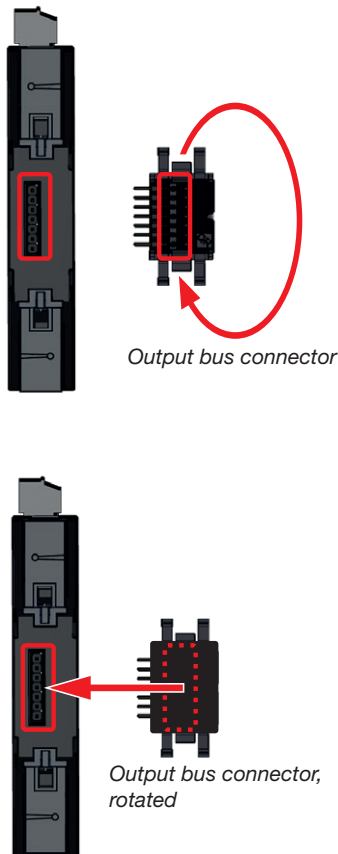

i INFORMATION

The following module assembly sequence must be observed!

3. Press your module with the bus connector onto the DIN rail (for suitable DIN rail types, see Sect. "9. Technical data" on p. 27) until the 2 bottom bolts engage.

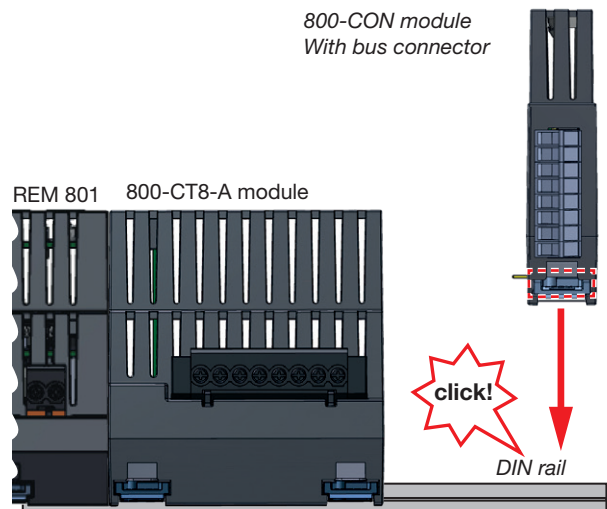

Fig.: Side view, REM 801, 800-CT8-A and 800-CON module

ATTENTION

Material damage due to voltage being applied to the basic device during installation!

Coupling while energized can destroy your basic device or the module!

- **Observe the warnings and safety information at the beginning of this chapter and check that your basic device is de-energized before connecting modules!**

4. Push the contacts of your module with output bus connector into the sockets of the connected module (or basic device) so that the bus connectors (devices) are coupled.

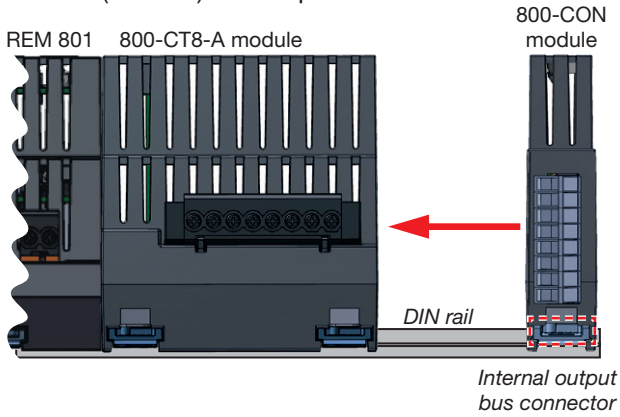

5. Check the fit of your measurement device and modules series and mount end brackets.

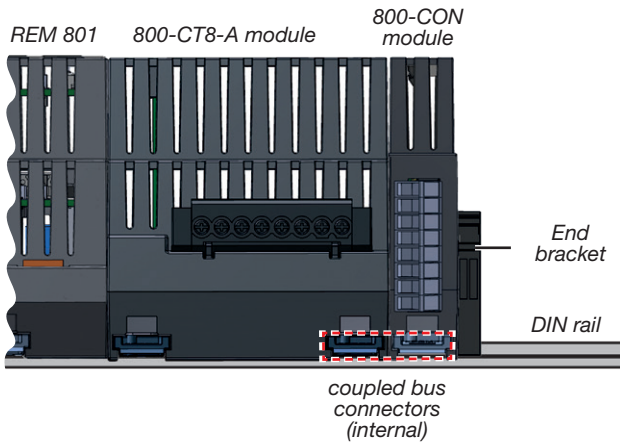

ⓘ INFORMATION

Always install the **800-CON transfer module with output bus connector** at the end of your measurement device and module topology.

4.2 Mounting the 2nd transfer module with input bus connector

For spatially distant module series, mount the **2nd 800-CON transfer module with input bus connector** while the system is disconnected from the power supply:

1. Press in the open bottom bolts on the rear of the module.

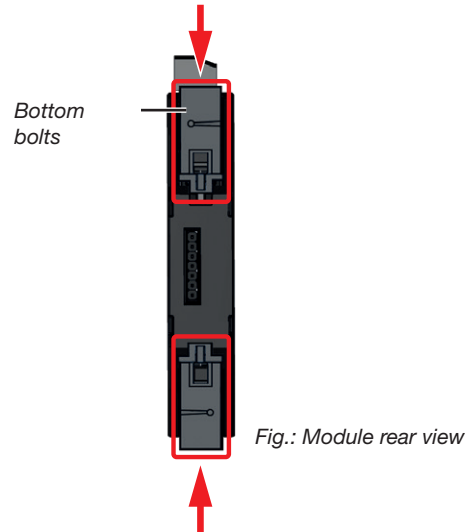

2. If not already done, plug the input bus connector (JanBus interface) included in the scope of delivery into the sockets on the back of the 2nd transfer module.

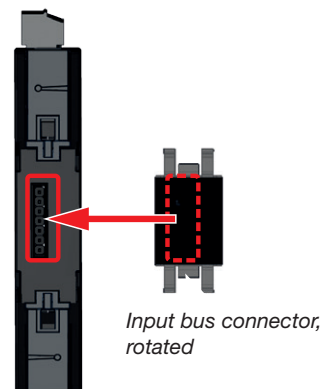
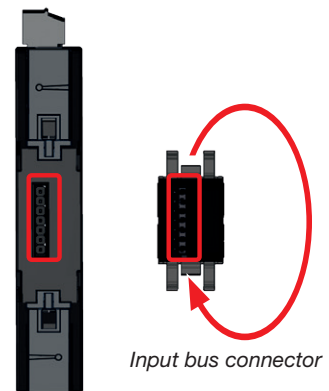



Press the bus connector contacts of the input bus connector into the module sockets

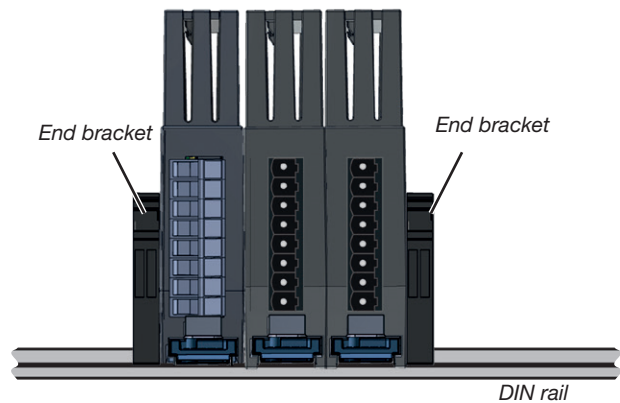

3. Press the 2nd transfer module with input bus connector onto the DIN rail until the bottom bolts audibly engage.

800-CON transfer module with input bus connector

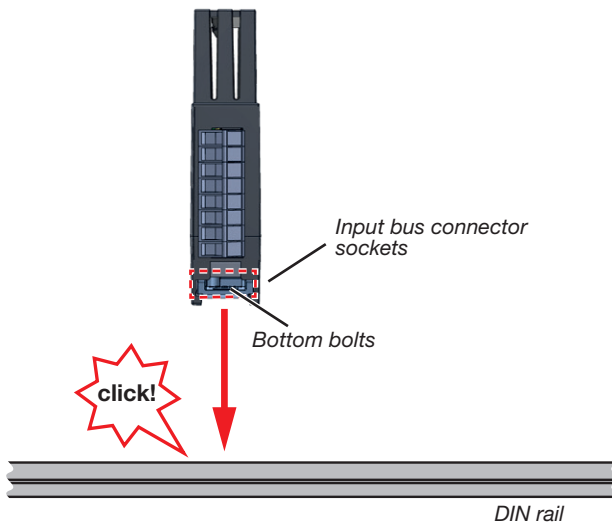

4. Mount further modules (e.g. current measuring modules, digital input modules) and push their contacts into the sockets of the input bus connector so that the devices are coupled to the transfer module.
5. Check the fit of your device and module series and mount end brackets.

6. Finally, wire your series of measurement devices and modules, observing the usage information for all integrated devices and modules.
7. Apply voltage to the basic device (system). The basic device detects the modules automatically.

i INFORMATION

- Always install the **800-CON transfer module with input bus connector** at the beginning of your remote measurement point (continuing module series (see Sect. "6. Installation" on p. 24)).
- In addition to the usage information for the basic device and the 800-CON transfer module (set of 2), please also note any other usage information for the modules and components integrated in your JanBus topology.
- For recommended data cables, refer to Sect. "6.2 Data cable for connecting the 800-CON transfer modules" on p. 25.
- The maximum bus length (JanBus - proprietary) for setting up measurement device and module topologies can be found in Sect. "9. Technical data" on p. 27.
- Use end brackets to set up your measurement device and module series on the DIN rails.

4.3 Connection of device and module series with the 800-CON transfer modules

To ensure trouble-free operation of your device series with modules and thus your system, connect your transfer modules via shield clamps. The shield connection serves as protection against overvoltages and electromagnetic interference. Also provide a strain relief during installation that protects the data cable from being torn out unintentionally. Connect the transfer modules with the recommended data cables. Please note the warnings and information below!

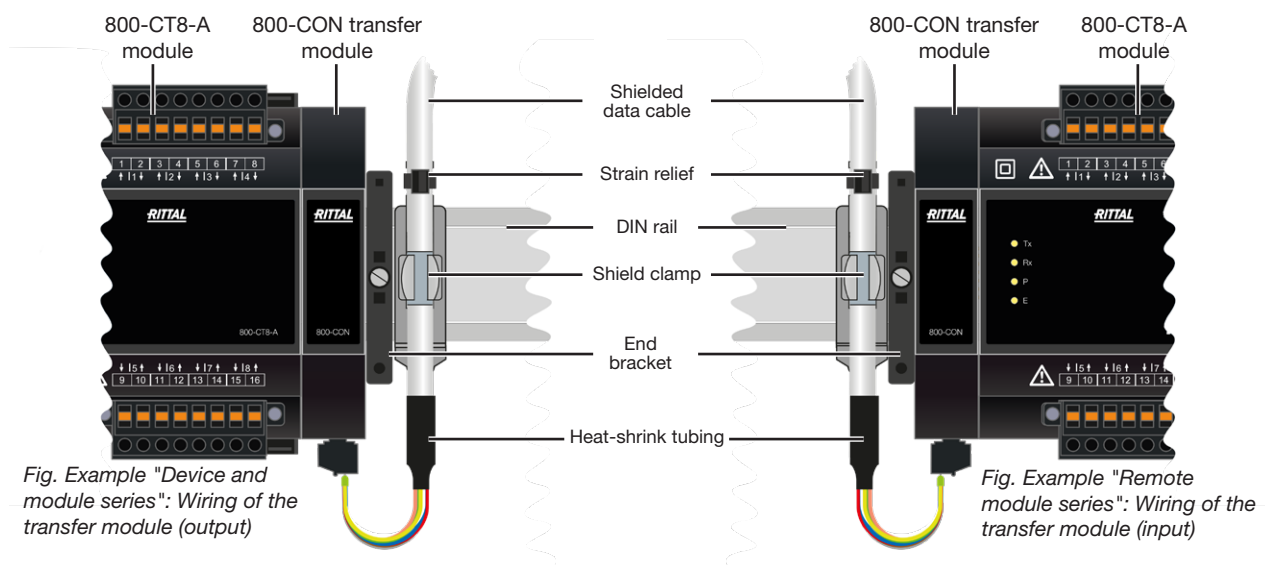

ATTENTION

Incorrect installation of the data cable can destroy your basic device with modules or your system!

A faulty or incorrectly installed data cable between the transfer modules can lead to the destruction of your basic device with modules and thus to material damage.

- For the connection between the transfer modules, use a stranded twisted pair, shielded data cable with a 1:1 cable connection (see **Sect. "6.2 Data cable for connecting the 800-CON transfer modules"** on p. 25)!
- **Always connect your transfer modules via shield clamps with a strain relief!**
- **Protect your system against overvoltages and electromagnetic interference by connecting the data cable shield to the shield clamp!**
- **Always connect the data cable shield (ground) within the same grounding potentials! With different ground potentials, connect the data cable shield at least at one end!**

INFORMATION

If the basic device does not recognize the module(s) during the power-up procedure, the module functions are not supported.

If there is no communication between the basic device and the modules, proceed as follows:

- **Disconnect your system from the power supply and check the condition of the bus connectors and the connections of your modules to the basic device (JanBus interface).** If necessary, push the contacts of the module bus connectors into the sockets of the basic device bus connector or the attached modules so that the bus connectors (devices) are coupled.
- For remote module series, check the connection of the transfer modules with the connection via the shield clamps.
- If necessary, restart the basic device.
- If these measures do not lead to the desired result, please contact our Support – email: service@rittal.com

5. Connections/controls

5.1 Connections/controls on 800-CON module

i INFORMATION

The transfer modules (800-CON) of the set of 2 are suitable as output or input modules!
However, make sure to mount the correct bus connectors (output and input)!

Always mount components of your JanBus system from the output bus connector to the input bus connector. This will avoid an incorrect connection of remote JanBus systems! Cf. Sect. "6.1 Data transfer with 800-CON module" on p. 24.

i INFORMATION

The transfer modules are supplied with the necessary screw terminals and bus connectors (JanBus interface) for connection to the basic device or other modules.

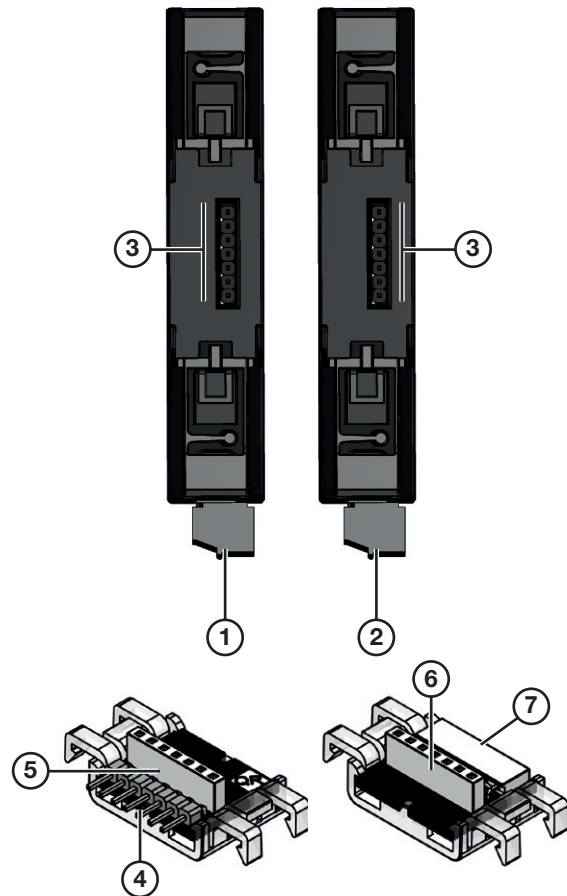
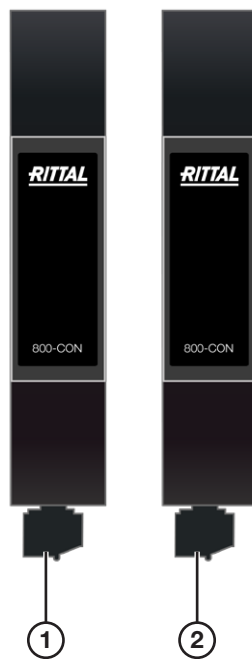

Item	Designation	Description
1	Screw terminals, 8-pole	Output or input module
2	Screw terminals, 8-pole	Output or input module
3	JanBus interface - rear of module	Connection sockets for the bus connector (note output/input!)
4	Transfer module output bus connector	Plug for insertion into the basic device or an attached module
5	Transfer module output bus connector	Connector for insertion into the rear of the module
6	Transfer module input bus connector	Connector for insertion into the rear of the module
7	Transfer module input bus connector	Sockets for module insertion

5.2 Marking of the 800-CON module - rating plate

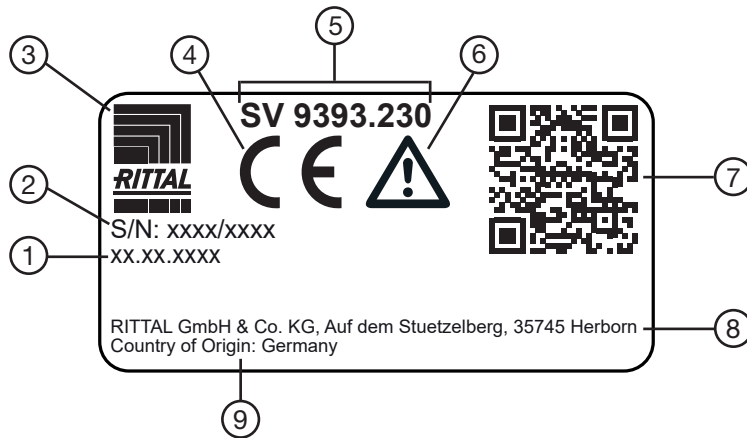

Item	Designation	Description
1	Manufacturer date	Day. Month. Year
2	Type/serial number	Number for identification of the device.
3	Trademark	Manufacturer- logo.
4	CE conformity marking	See Sect. "3.5 Declaration of conformity" on p. 13.
5	Part number	Manufacturer's part number - marking for traceability.
6	Symbol for "Danger sign"	General warning symbol. Be certain to observe the warning notices applied to the device and shown in the usage information in order to avoid possible injury or even death.
7	QR-Code	Further information.
8	Manufacturer's address	Full address of the device manufacturer.
9	Designation of origin	Country of origin.

Tab.: Device identification, rating plate

6. Installation

! WARNING

Risk of injury due to high currents and high electrical voltages!

Severe bodily injury or death can result from:

- Touching bare or stripped leads that are energized.
- Inputs of devices, components and modules are dangerous to touch.

Therefore, please note for your system:

- **Disconnect the supply of power before starting work!**
- **Secure it against being switched on!**
- **Check to be sure it is de-energized!**
- **Ground and short circuit! Use the ground connection points with the ground symbol for grounding!**
- **Cover or block off adjacent live parts!**

6.1 Data transfer with 800-CON module

Your 800-CON transfer module (set of 2) in combination with a basic device (REM 801) and, for example, current measuring modules, serves to connect remote measurement points.

With the transfer modules, you can implement measurement device and module topologies (e.g. REM 801 with 800-CT8-A current measuring modules) with flexible arrangement of your DIN rails in the switchboard cabinet or small distribution board (for DIN rail types, see chapter „9. Technical data“ on page 27).



Fig. Example of a meter and module topology

6.2 Data cable for connecting the 800-CON transfer modules

Recommendation:

Use the following data cables for smooth communication in your meter and module topology for connecting the 800-CON transfer modules:

Twisted pair, shielded data cable with color code to DIN 47100 (4 x 2 x 0.25) - Lapp Unitronic LiYCY (TP)

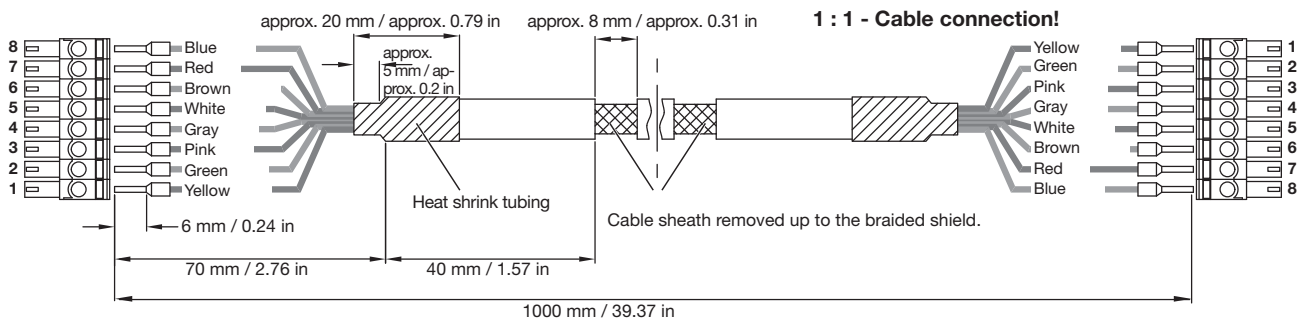

Stranded twisted pair hook-up wire, Lapp LiY 0.25², black/blue.

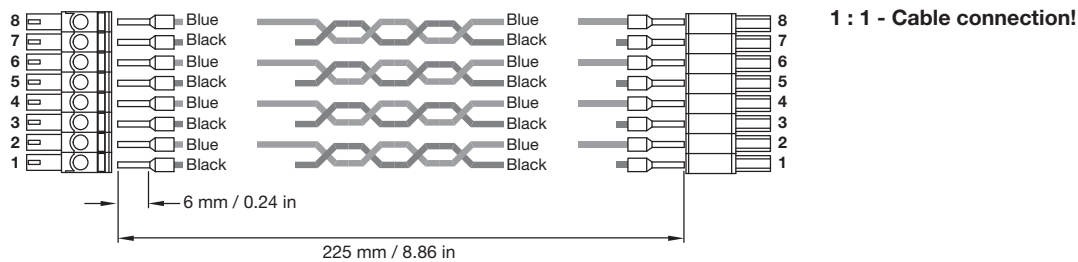

7. Operation and button function of the meter and module topology

The installation, commissioning and configuration of your meter and module topology is carried out without a PC via the REM 801 basic device. The REM 801 has a display and 6 function buttons.

i INFORMATION

For details and information on the display and button functions of the basic device, refer to the usage information of the basic device.

8. Device views - 800-CON transfer module

- The figures are for illustration purposes only and are not to scale.
 - Dimensions in mm (in).
- The **set of 2** delivered transfer modules (800-CON) can be used for output or input.

Rear view

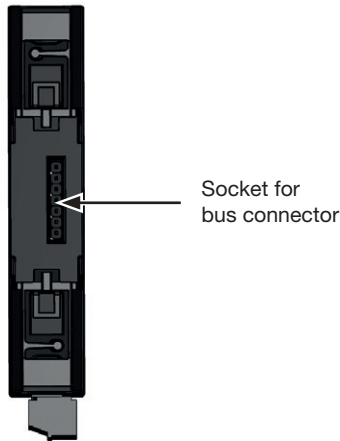

Bus connector for the output transfer module (output bus connector)

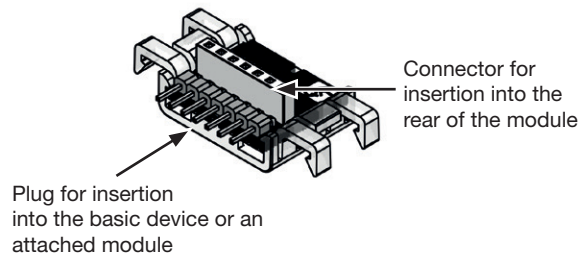

Bottom view



Top view



Bus connector for the input transfer module (input bus connector)

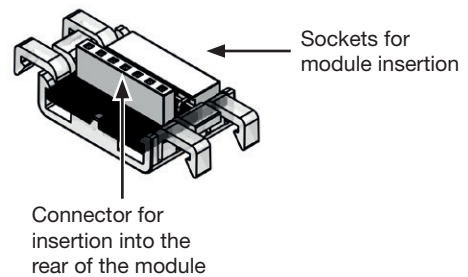

Front view



View from left

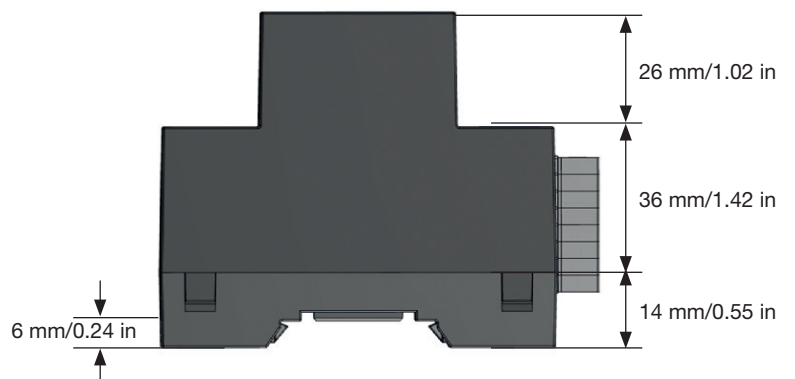

9. Technical data

General	
Net weight (with plug-in terminals)	approx. 55 g (0.12 lb) - 1 device
Device dimensions	Approx. B = 18 mm (0.71 in), H = 90 mm (3.54 in), D = 76 mm (2.99 in)
Width of the modules (set of 2) in horizontal pitches (HP)	1 HP each (1 HP = 18 mm / 0.71 in)
Mounting orientation	As desired
Fastening/mounting - Suitable DIN rails - (35 mm / 1.38 in)	TS 35/7.5 according to EN 60715 TS 35/10 TS 35/15 x 1.5
Impact resistance	IK07 according to IEC 62262

Transport and storage	
The following specifications apply for devices transported and stored in the original packaging.	
Free fall	1 m (39.37 in)
Temperature	K55: -25° C (-13 °F) to +70° C (158 °F)
Relative humidity	5 to 95% at 25 °C (77 °F), no condensation

Environmental conditions during operation	
The modules (set of 2) · must only be operated with suitable basic devices. · is for weather-protected and stationary use. · fulfill operating conditions according to DIN IEC 60721-3-3. · have protection class II according to IEC 60536 (VDE 0106, part 1), a ground wire connection is not required!	
Rated temperature range	-10 °C (14 °F) to +55 °C (131 °F)
Relative humidity	5 to 95% at 25 °C (77 °F), no condensation
Pollution degree	2
Ventilation	No forced ventilation required.
Protection against foreign matter and water	IP20 according to EN60529

Interface	
JanBus (proprietary) NOTE! To connect the transfer modules, use a stranded twisted pair, shielded data cable (cable connection 1:1)!	· Via bus connector to device and module series · Via shield terminals between the transfer modules with stranded twisted pair, shielded data cable (cable connection 1:1) - see Sect. "6.2 Data cable for connecting the 800-CON transfer modules" on p. 25. · The maximum bus length of the JanBus is 100 m .

Terminal connection capacity	
Connectible conductors. Only connect one conductor per terminal point!	
Single core, multi-core, fine-stranded	0.2 - 1.5 mm ² , AWG 24-16
Wire ferrules (non-insulated)	0.2 - 1.5 mm ² , AWG 26-16
Wire ferrules (insulated)	0.2 - 1 mm ² , AWG 26-18
Tightening torque	0.2 - 0.25 Nm (1.77 - 2.21 lbf in)
Strip length	7 mm (0.2756 in)

10. Dismounting

ATTENTION

Handling your module too roughly may cause damage to the module and result in material damage!

The bus connector contacts and the bottom bolts can be damaged or broken off when dismantling your module.

- **Never pull the module out of the DIN rail forcefully.**
- **First decouple the bus connectors (JanBus interface) and carefully unlock the bottom bolts of the module with a screwdriver!**

ATTENTION

Material damage due to disassembly or decoupling of the module during operation!

Dismounting or decoupling the module during communication with the basic device can cause damage to your devices!

- **Disconnect your system from the power supply prior to dismantling or disconnecting the module! Secure it against being switched back on! Check to be sure it is de-energized! Ground and short circuit! Cover or block off adjacent live parts!**

1. Disconnect the supply of power to the system! Secure it against being switched on! Check to be sure it is de-energized! Ground and short circuit! Cover or block off adjacent live parts!
2. Disconnect the wiring and the connection terminal.
3. Remove or shift the shield terminal and end bracket of your device and module series (if necessary, loosen the strain relief).
4. Disconnect the bus connectors (JanBus interface) of the transfer module from the basic device and/or the connected module by pulling them out.
5. Unlock the bottom bolts of the transfer module. **Recommendation:** Use a screwdriver (be careful!).
6. Remove the transfer module from the DIN rail without touching or damaging the bus connector contacts.

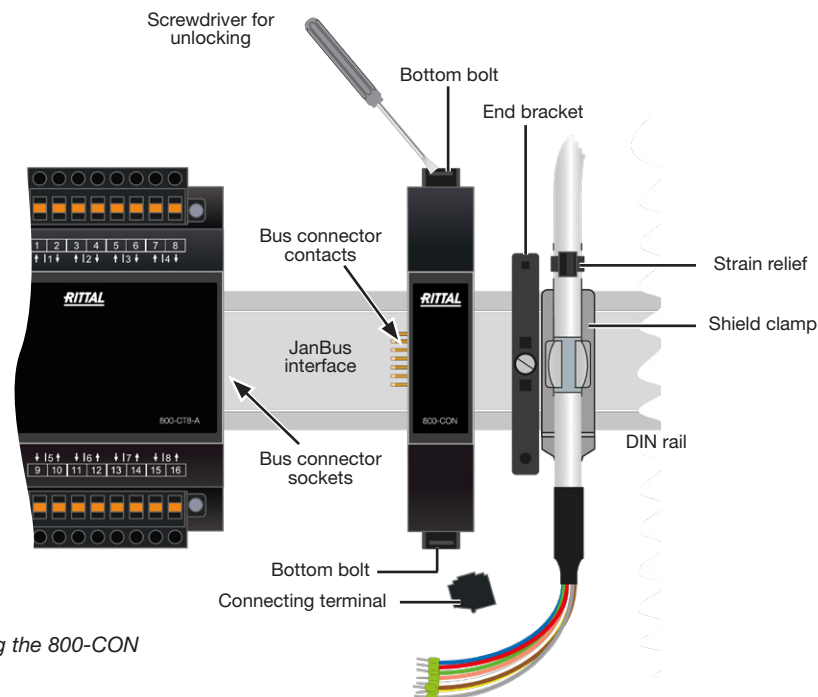

Fig. Dismounting the 800-CON module

i INFORMATION

For trouble-free operation of your module series with transfer modules, please refer to Sect. "6.1 Data transfer with 800-CON module" on p. 24.

11. Service and maintenance

Prior to outbound delivery, your device (component/module) is subjected to various safety tests and is marked with a seal. If the device (component/module) is opened, the safety tests must be repeated. The warranty is only valid for unopened devices (components/modules).

11.1 Repair

Repairs can only be carried out by the manufacturer.

11.2 Service

If questions arise that are not described in this user manual, please contact the manufacturer.

The particulars and information required to identify problems with the device, module or component should be as complete as possible. Consequently, please have the following information ready to answer any questions:

- Device designation (see rating plate).
- Measured voltage and supply voltage.
- An exact error description.

If available:

- Serial number (see rating plate).
- Hardware version (see system display).
- Software release (see system display).

11.3 Device adjustment

Devices (components/modules) are adjusted by the manufacturer prior to outbound delivery. No readjustment is required when the environmental conditions are complied with.

11.4 Calibration interval

No calibration is required for the 800-CON transfer module (set of 2). For the calibration of further components and modules of your meter and module topology, please refer to the respective usage information.

11.5 Firmware update

No firmware update is required for the 800-CON transfer module (set of 2). For a firmware update of the further components and modules of your meter and module topology, please refer to the respective usage information.

INFORMATION

This user manual describes the modules and provides information on the operation of the modules via the basic device.

In addition to this user manual, also take note of the usage information for the respective components and modules in your meter and module topology.

11.6 Procedure in the event of a malfunction

ATTENTION

An error in the communication with the basic device leads to a device fault!

If communication from the basic device to the modules is lacking or faulty during operation, a warning signal will appear on the display of the basic device.

Prior to dismantling or disconnecting the modules of the basic device (the system)

- **Disconnect the supply of power! Secure it against being switched on! Check to be sure it is de-energized! Ground and short circuit! Cover or block off adjacent live parts!**
- **Prior to remounting, it may be necessary to restart the basic device.**
- **Also take note of the chapter "Procedure in the event of a malfunction" in the documentation of your basic device.**
- **If the measures indicated here are unsuccessful, please contact our support team - email: service@rittal.de.**
- **If there is discernible damage, send the device, component or module back to the manufacturer in compliance with proper transport conditions.**

11.7 Resetting the module to the standard factory settings

The 800-CON transfer module (set of 2) does not require a "reset to factory settings".

RITTAL GmbH & Co. KG
Auf dem Stuetzelberg
D-35745 Herborn • Germany
Phone +49 (0)2772-505-0
Email: info@rittal.com
www.rittal.com

RITTAL