

SZ

2577.010

AX, KX plastic handle
Only for use with Rittal
AX / KX series products

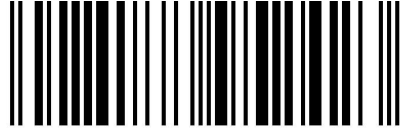

4028177952423



Raum für Verpackungsdatum
Area for date of packing
(MMJJTT / MMYDD)

1x

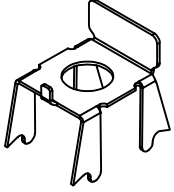

1x

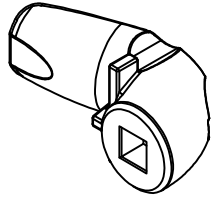

AX
Compact
enclosure

1x

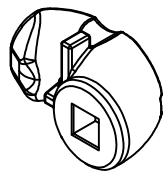

KX E-Box

1x



M5x16

1x

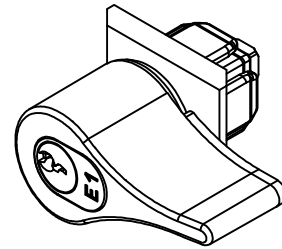

VW E1

1x

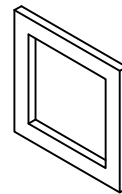

Dok.-Nr. / No. of doc.: A09122102SZ

Versandbeutel-Nr. / No. of accessory bag:

Made in XXXXX

Lieferanten-Nr. / No. of supplier:

RITTAL GmbH & Co. KG, Auf dem Stuetzelberg, 35745 Herborn
RITTAL Limited, Braithwell Way, Hellaby, Rotherham, S66 8QY, UK

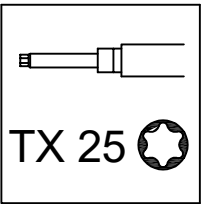

TX 25

AX Compact enclosure

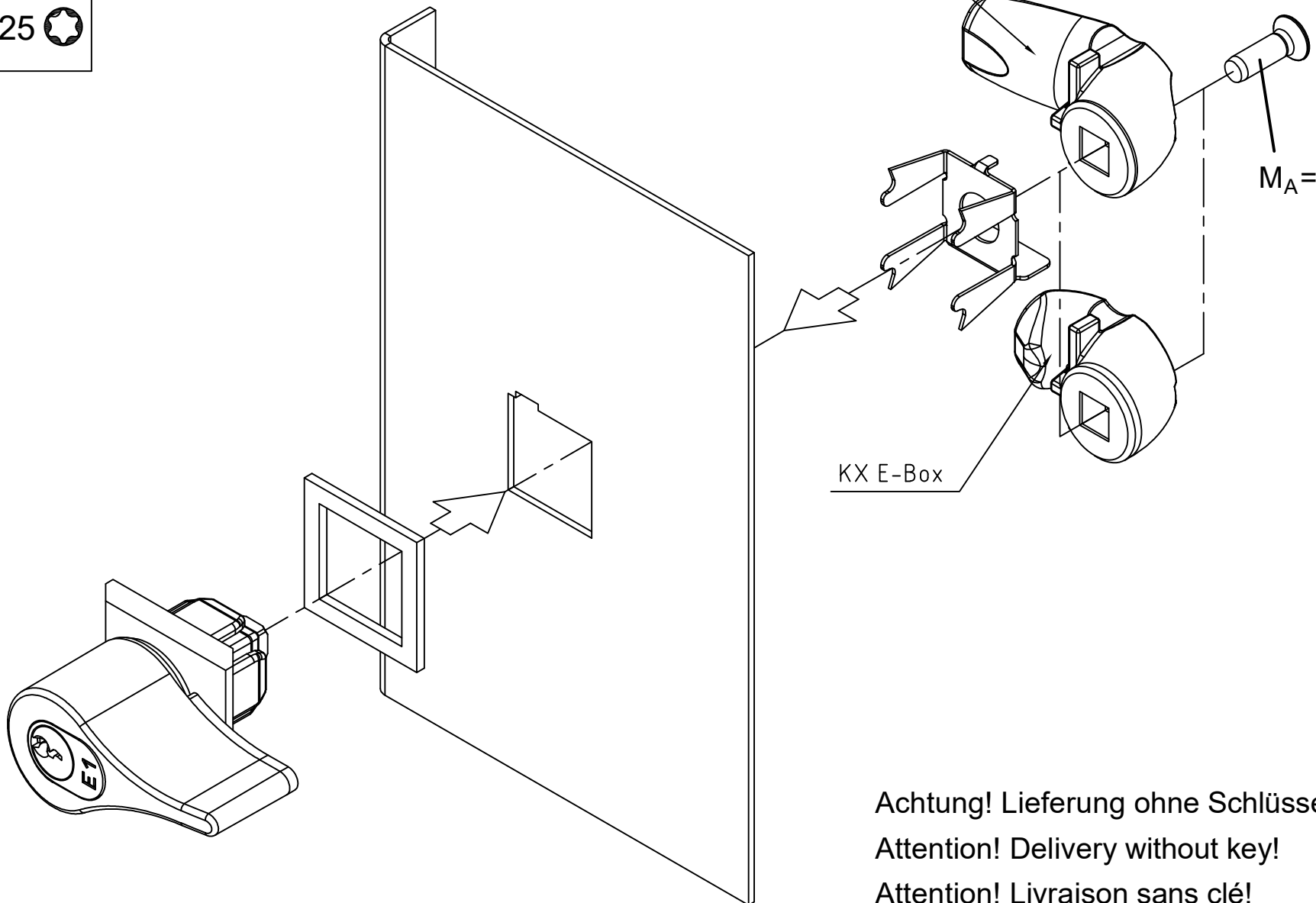

$M_A=1+0,5Nm$

KX E-Box

Achtung! Lieferung ohne Schlüssel!
Attention! Delivery without key!
Attention! Livraison sans clé!