

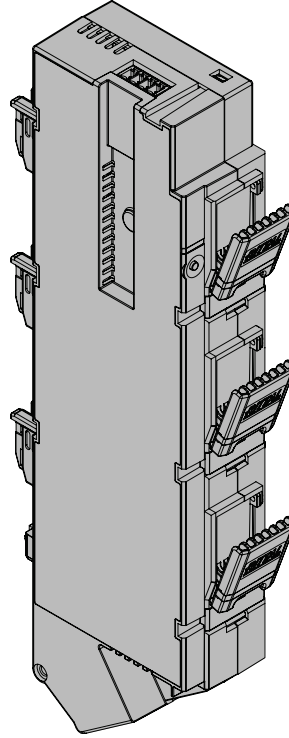







www.rittal.com

1 x



	Rundleiter eindrätig Round conductor single-wire Conducteur rond, unifilaire	Rundleiter mehrdrätig Round conductor multi-wire Conducteur rond, multifilaire	Feindrätig Fine wires Fils fins	Feindrätig mit isolier- ter Aderendhülse Fine wires with insula- ted ferrule Fils fins, avec embout isolé	Feindrätig mit uniso- lierter Aderendhülse Fine wires with uninsu- lated ferrule Fils fins, avec embouts non-isolés
					
IEC	2,5 ... 16 mm ² (Cu)	2,5 ... 16 mm ² (Cu)	2,5 – 16 mm ² (Cu) (feindrätig + Aderendhülse eventuell nicht mit maximalem Querschnitt möglich) (fine-wire + wire end ferrule may be not possible with the maximum cross-section) (fils de faible diamètre + embout éventuellement impossible avec section maximale)		

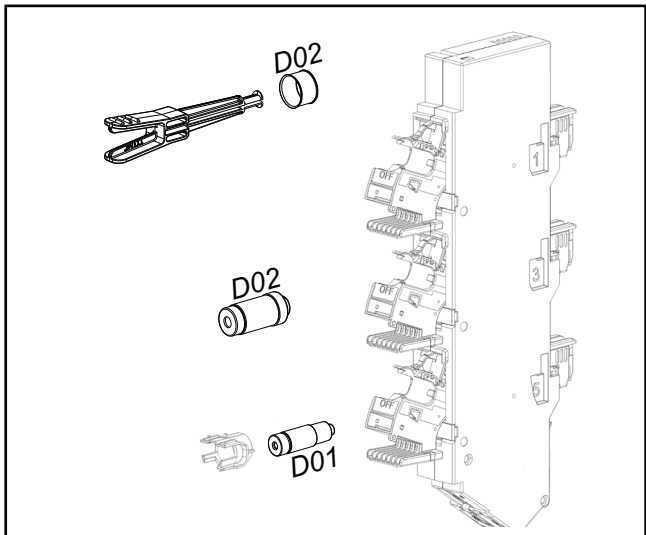
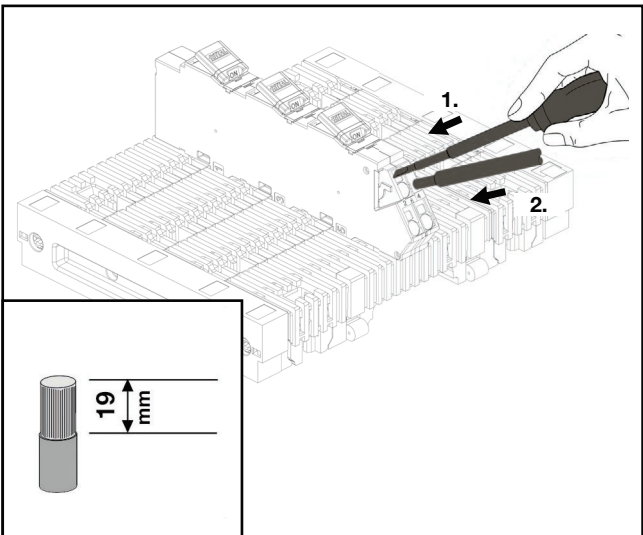
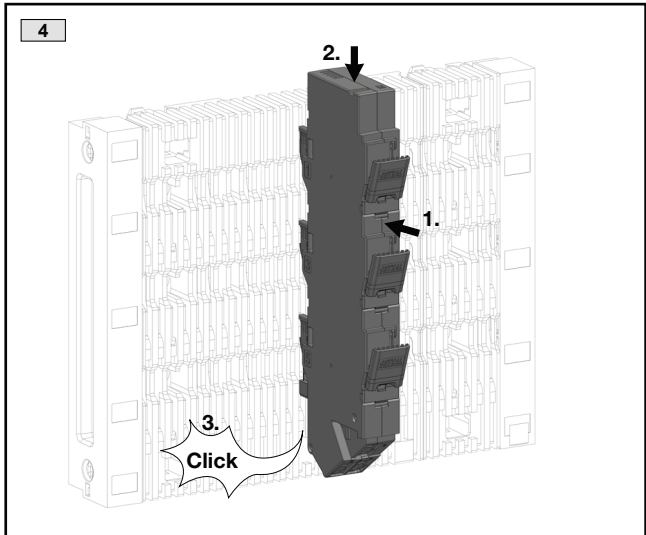
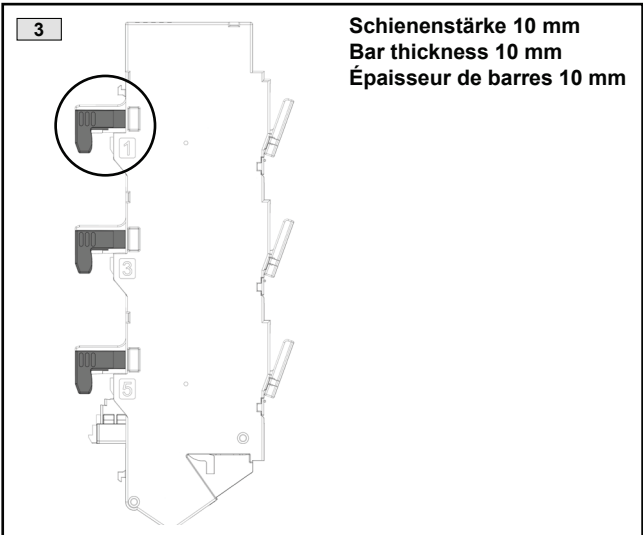
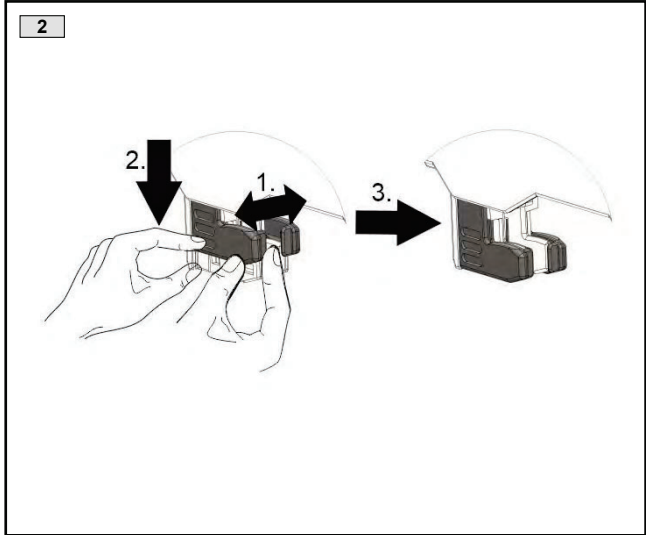
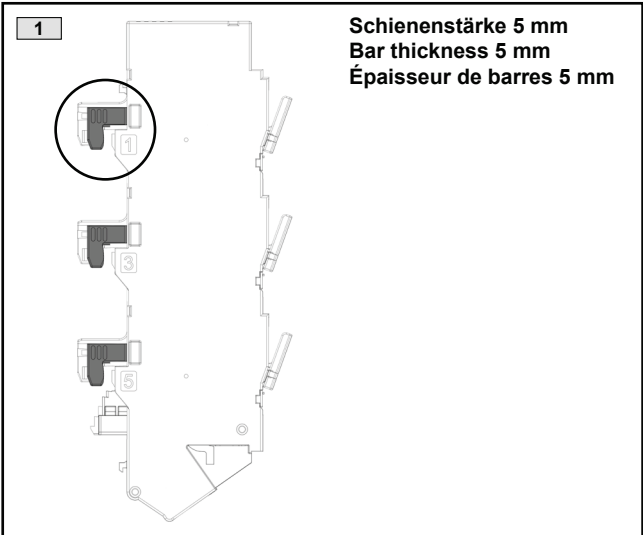
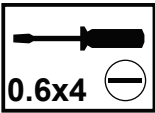

Bauteil Component Composant	Baugröße Size Taille	Wert Value Intensité	Bemerkung Comment Remarque
Passhülse Adaptor sleeve Douille de calibrage	D02	2 ... 50 A	-
Sicherungseinsatz Fuse insert Type de fusibles	D01	2 ... 16 A	nur mit Reduzierfeder only with reduction spring seulement avec ressort de réduction
	D02	20 ... 63 A	-