

# Enclosures

## CX console system

### CX console 600/800 mm width

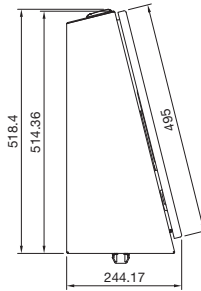
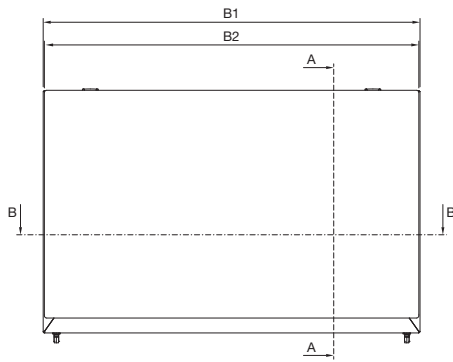

Section A – A

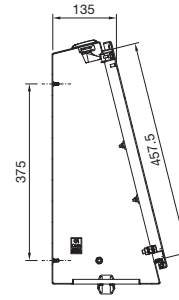

Section B – B

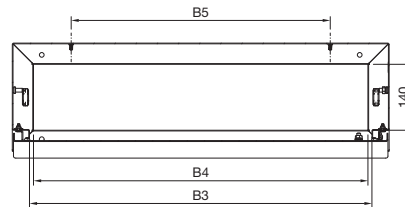
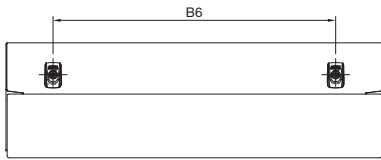

Internal view of cover

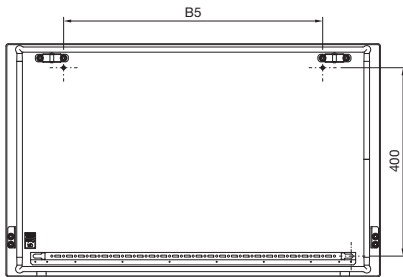

- B1 = Enclosure width
- B2 = Cover width
- B3 = Clearance width, front
- B4 = Clearance width, bottom
- B5 = Mounting distance, interior installation
- B6 = Spacing between locks

Model No. CX	Width dimensions mm					
	B1	B2	B3	B4	B5	B6
6720.000	600	595	527	510	350	400
6721.000	800	795	727	710	550	600

### CX console

1200/1600 mm width

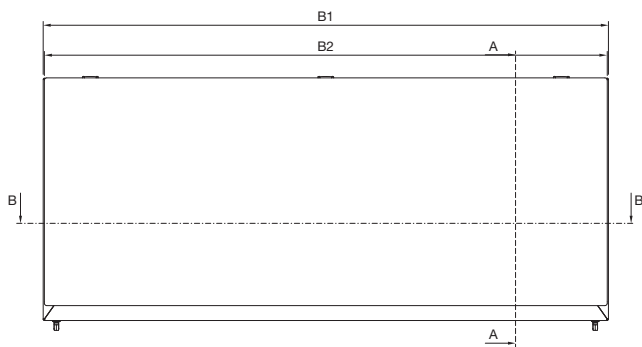

Section A – A

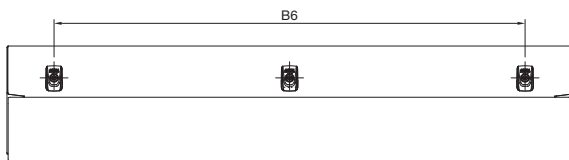
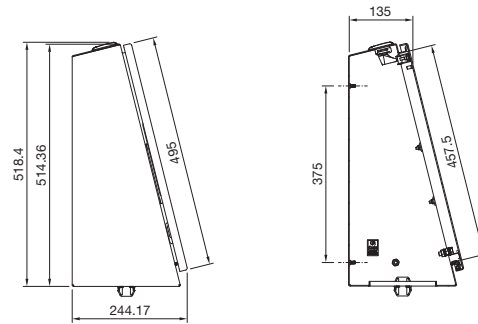

Section B – B

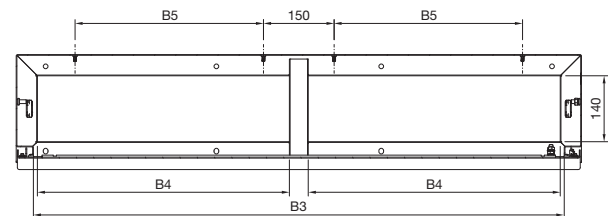

Internal view of cover

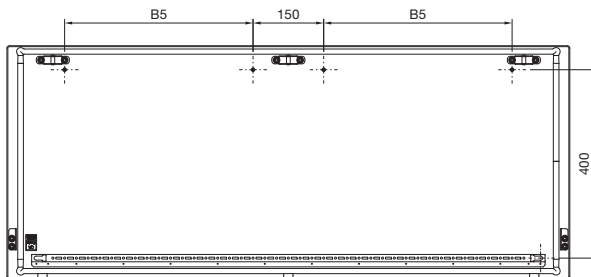

- B1 = Enclosure width
- B2 = Cover width
- B3 = Clearance width, front
- B4 = Clearance width, bottom
- B5 = Mounting distance, interior installation
- B6 = Spacing between locks

Model No. CX	Width dimensions mm					
	B1	B2	B3	B4	B5	B6
6722.000	1200	1195	1127	535	400	1000
6723.000	1600	1595	1527	735	600	1400