

# Kytöntäkaapit

## Pienkotelot

### BG-väyläkotelot

Päälueetelo 33, sivu 39

BG 1583.520, BG 1584.520, BG 1585.520, BG 1586.520

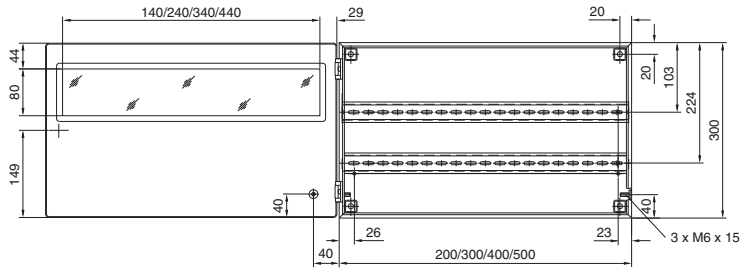

BG 1583.520

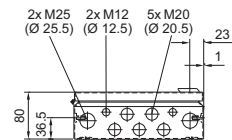

BG 1584.520

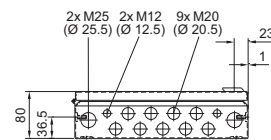

BG 1585.520

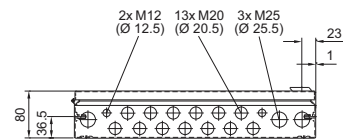

BG 1586.520

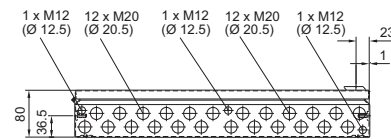

Päälueetelo 33, sivu 40

BG 1605.520, BG 1606.520

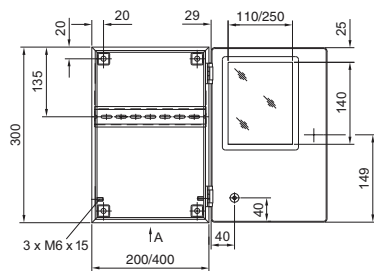

BG 1605.520

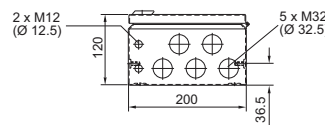

BG 1606.520

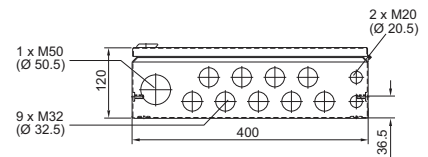

Päälueetelo 33, sivu 40

BG 1558.510, BG 1559.510

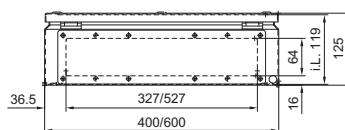
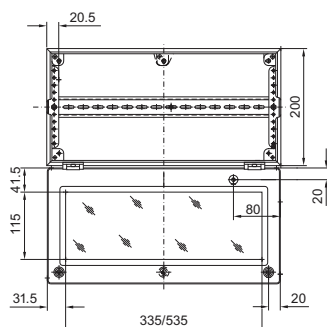

### BG-väyläkotelot

Päälueetelo 33, sivu 40

Til.nro BG	Mitat mm					Laitteikkunan korkeudet mm		Laippojen aukotus i.L. x i.L. <sup>1)</sup> mm
	B	H	T	F1	G1	H1	H2	
1577.500	400	300	155	385	275	-	-	327 x 97
1577.520						115	92	
1577.530						190	42	
1577.550						115	92	
1577.560						190	42	
1577.450	600	300	155	585	275	155	92	527 x 97
1578.500						-	-	
1578.520						115	92	
1578.530						190	42	
1578.550						115	92	
1578.560	190	42						
1578.450	800	300	155	785	275	-	-	327 x 97 (2 x)
1579.500						115	92	
1579.520						190	42	
1579.530						115	92	
1579.550						190	42	
1579.560	155	92						
1579.450						155	92	-

<sup>1)</sup> Laippalevyt ympäriinsä 14 mm suurempia.

i.L. = Sisämitta

B = Leveys, H = Korkeus, T = Syvyys

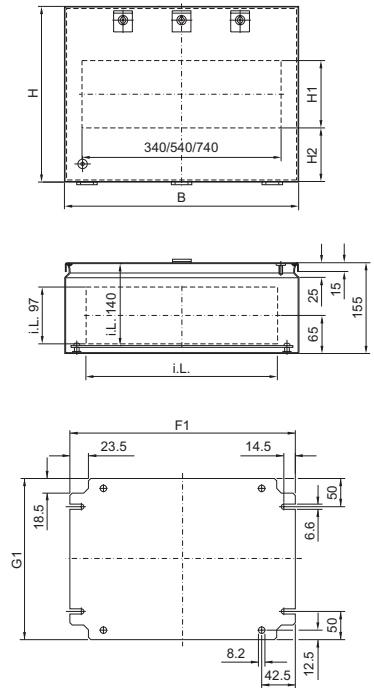

Päälueetelo 33, sivu 41

BG 1611.510

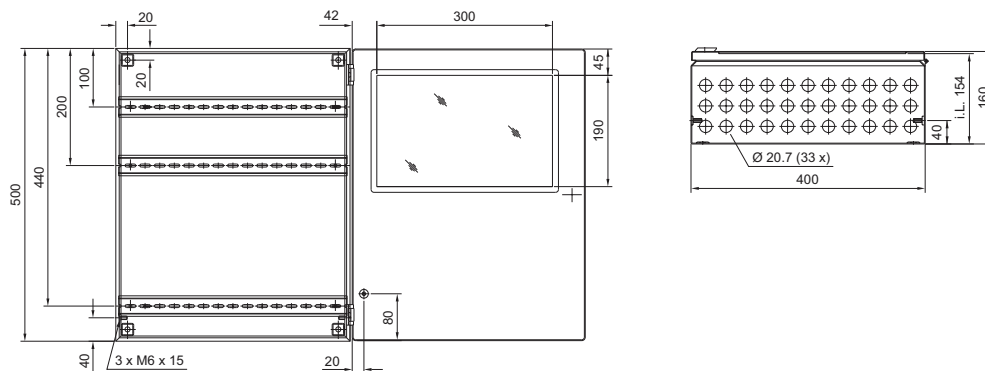

Päälueetelo 33, sivu 41

BG 1609.510

