

Væskekøling

Luft-/vandvarmevekslere

Topmonterede, SK 3209.XXX, SK 3210.XXX

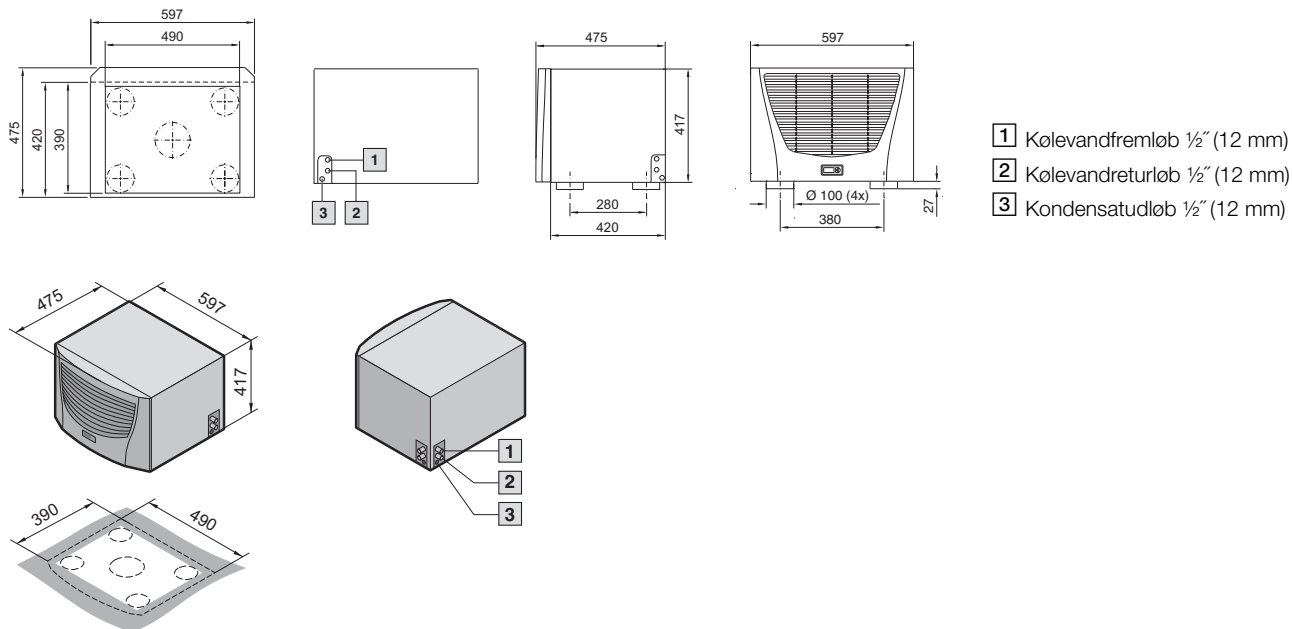

Vertikalmonteret, SK 3212.XXX

Montagehuller til indbygning

Montageudskæring til påbygning

- 1 Kondensatudløb ¾"
 2 Kølevandstilslutning ¾"

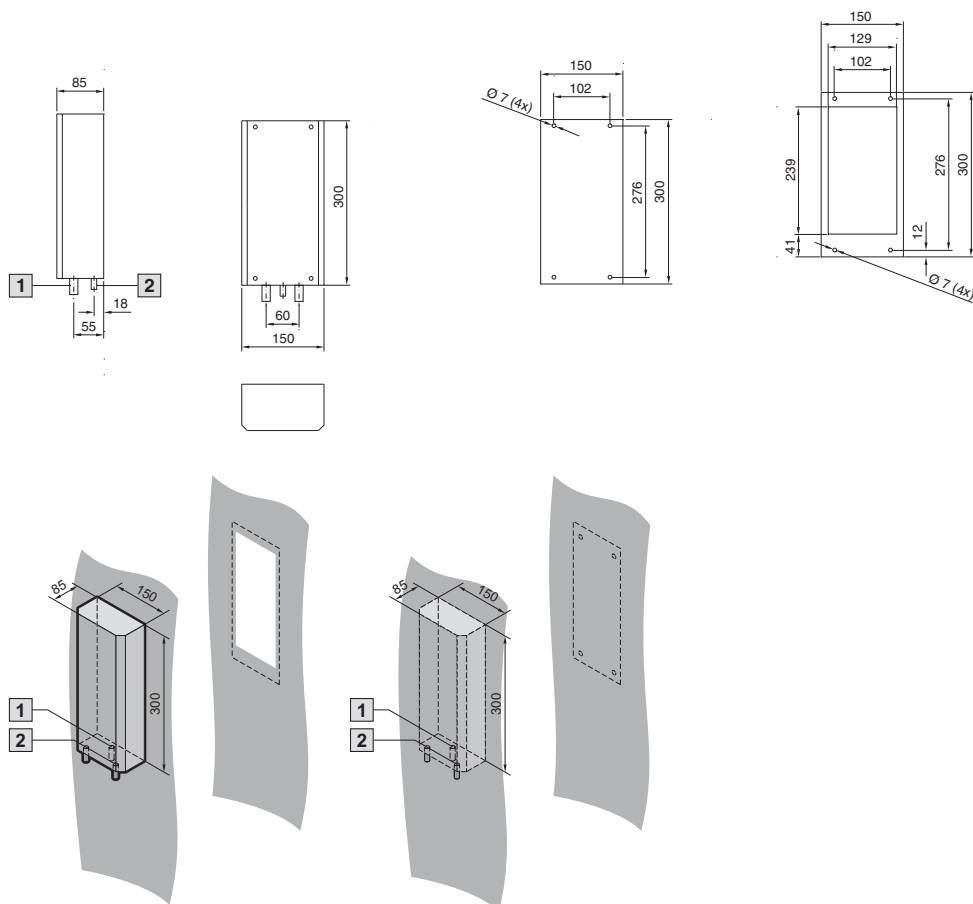

Luft-/vandvarmevekslere

Vertikalmonteret, SK 3214.XXX

Montagehuller til indbygning

Montageudskæring til påbygning

- 1 Kondensatudløb 1/2"
- 2 Kølevandstilslutning 1/2"

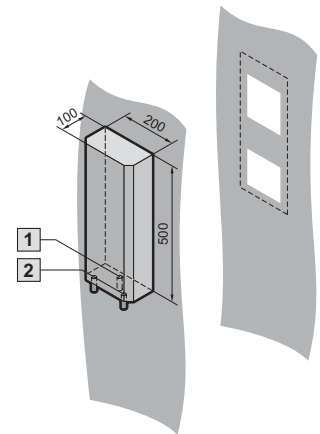
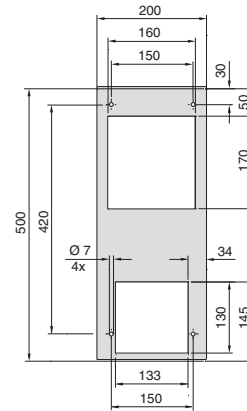
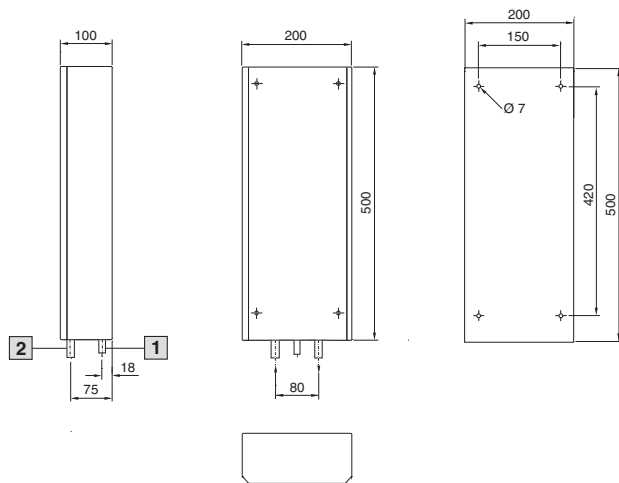

Vertikalmonteret, SK 3215.XXX

Montagehuller til indbygning

Montageudskæring til påbygning

- 1 Kondensatudløb 1/2"
- 2 Kølevandstilslutning 1/2"

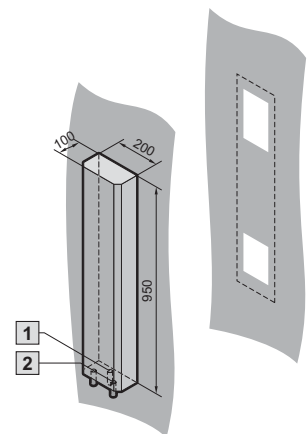
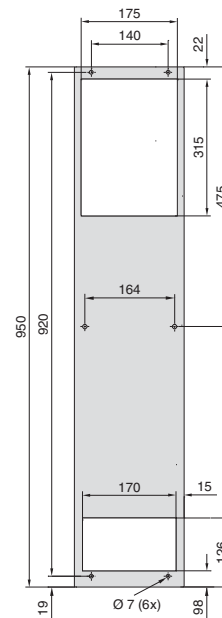
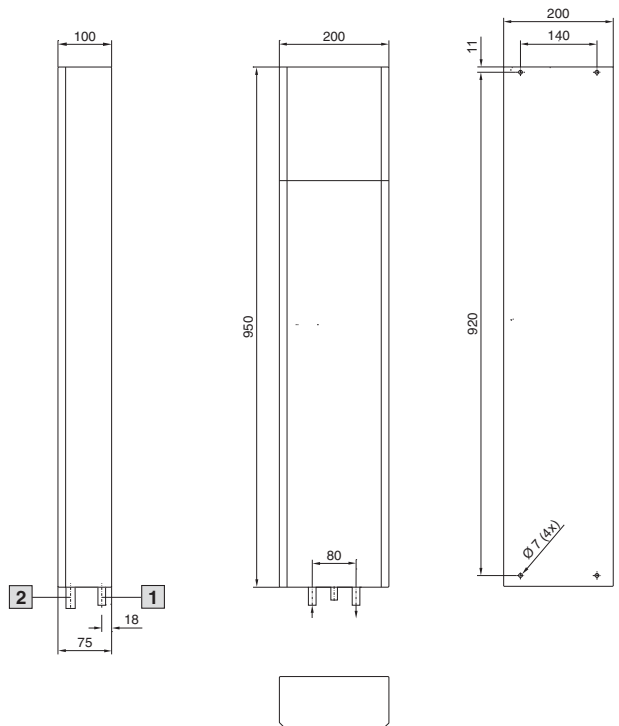

Væskekøling

Luft-/vandvarmeveksler

Vertikalmonteret, SK 3363.XXX, SK 3364.XXX

Montageudskæring til påbygning

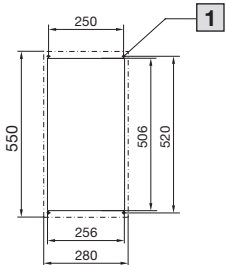

Montageudskæring til indbygning

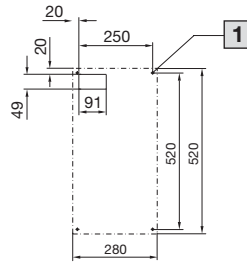

- 1 Ø 6,5 mm (4 x ved ind- og påbygning)
- 2 Vandtilslutninger 1/2" slangetylle eller G 3/8" udv. gevind
- 3 Kondensatudløb 1/2"

Påbygning

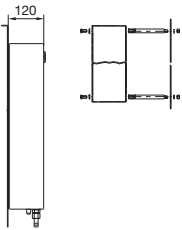

Indbygning

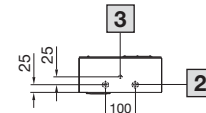
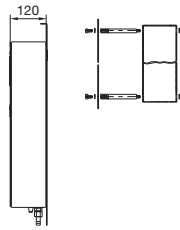

Vertikalmonteret, SK 3373.XXX, SK 3374.XXX

Montageudskæring til påbygning

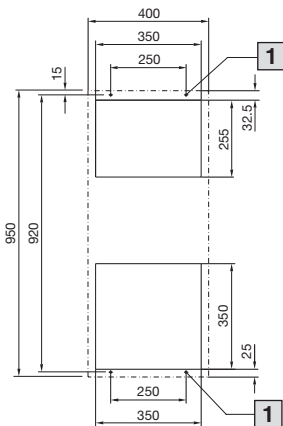

Montageudskæring til indbygning

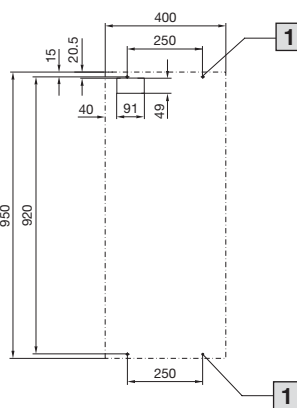

- 1 Ø 6,5 (4 x ved ind- og påbygning)
- 2 Vandtilslutninger 1/2" slangetylle eller G 3/8" udv. gevind
- 3 Kondensatudløb 1/2"

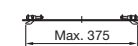
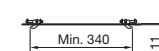
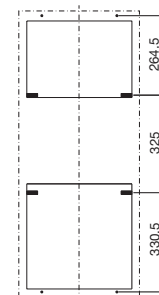

Påbygning

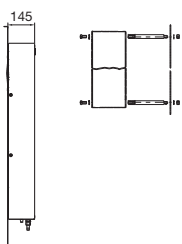

Indbygning

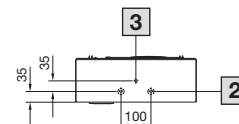
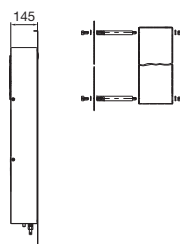

Luft-/vandvarmeveksler

Vertikalmonteret, SK 3375.XXX

Montageudskæring
til påbygning

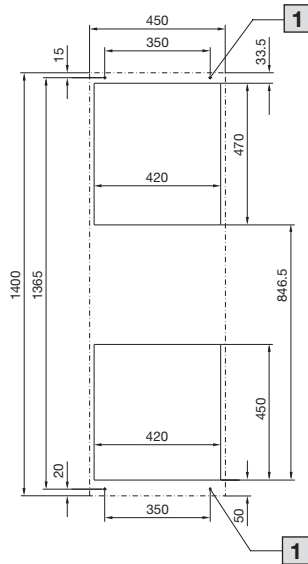

Montageudskæring
til indbygning

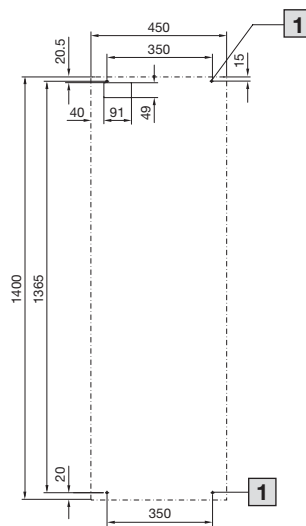

- 1 Ø 6,5 (4 x ved ind- og påbygning)
- 2 Vandtilslutninger 1/2" slangetylle eller G 3/8" udv. gevind
- 3 Kondensatudløb 1/2"

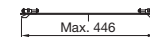
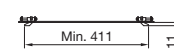
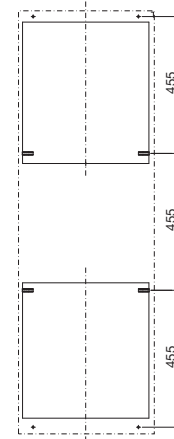

Påbygning

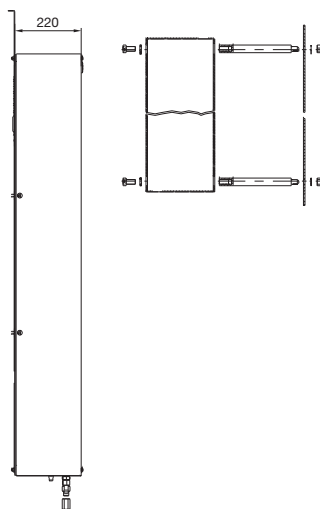

Indbygning

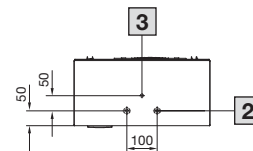
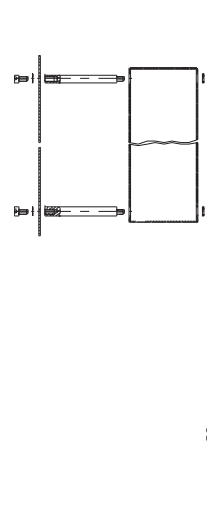

Luft-/vandvarmeveksler

Vertikalmonteret, SK 3216.480

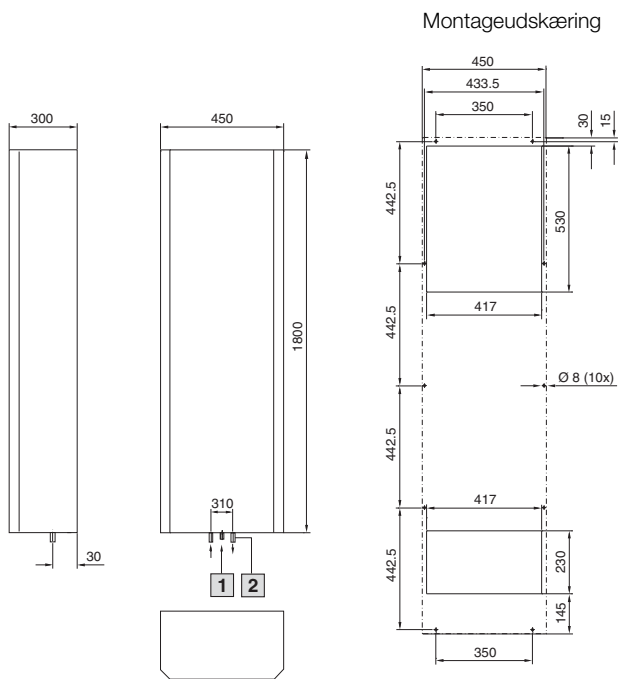

- 1 Kondensatudløb 1/2"
- 2 Kølevandstilslutning 1/2"

