

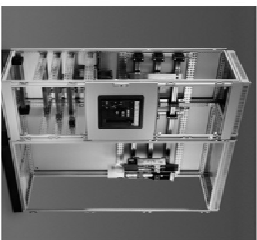

Schaltschrank-Systeme
Industrial Enclosures
Coffrets et armoires électriques
Kastsystemen
Apparatskåpsystem
Armadi per quadri di comando
Sistemas de armarios
インダストリアルエレクトロニクスケーシング

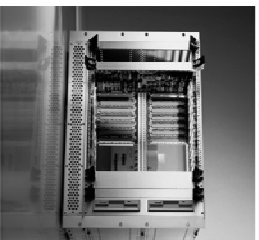

Stromverteilung
Power Distribution
Distribution de courant
Stroomverdeling
Strömfordelning
Distribuzione di corrente
Distribución de corriente
分電・配電システム



Elektronik-Aufbau-Systeme
Electronic Packaging
Electronique
Electronic Packaging Systems
Electronic Packaging
Contentitori per elettronica
Sistemas para la electrónica
エレクトロニクスパッケージングシステム



System-Klimatisierung
System Climate Control
Climatisation
Systemklimatisering
Systemklimatisering
Soluzioni di climatizzazione
Climatización de sistemas
温度管理システム



IT-Solutions
IT Solutions
Solutions IT
IT-Solutions
IT-lösningar
Soluzioni per IT
Soluciones TI
ITソリューション



Communication Systems
Communication Systems
Armoires outdoor
Outdoor-behuzingen
Communication Systems
Soluzioni outdoor
Sistemas de comunicación
コミュニケーションシステム

10/10 - A3729602TS74



Rittal GmbH & Co. KG · Postfach 1662 · D-35726 Herborn
Telefon +49(0)2772 505-0 · Telefax +49(0)2772 505-2319 · eMail: info@rittal.de · www.rittal.de

Rittal TS

Anreihrahmen
Type 4 / 4x

Bayling frame
Type 4 / 4x

Armature de raccordement
Modèle 4 / 4x

Verbindend kader
Type 4 / 4x

Förbindingsram
Type 4 / 4x

Struttura di collegamento
Tipo 4 / 4x

Marco de conexión
Tipo 4 / 4x

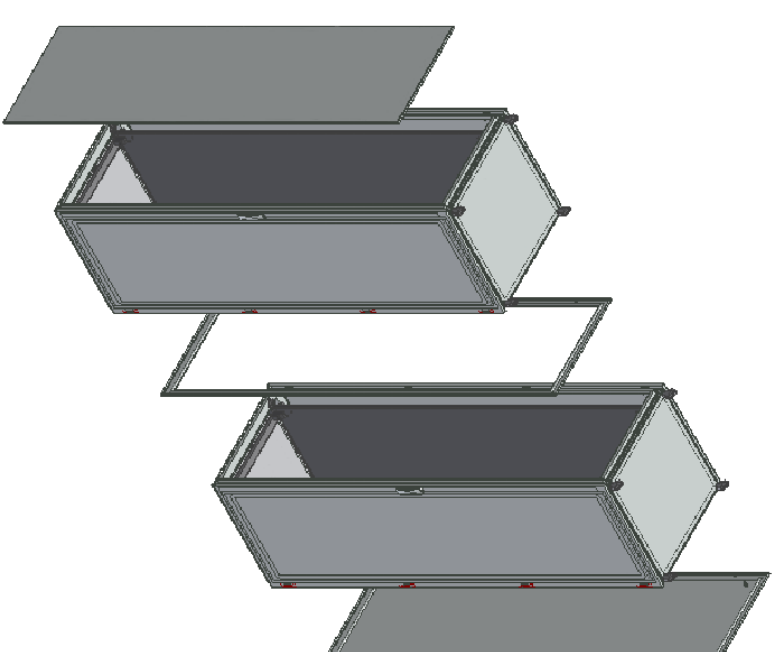

TS 8700.010

- Montage- und Bedienungsanleitung
- Assembly and operating instructions
- Notice de montage et mode d'emploi
- Montage- en bedieningshandleiding
- Montage- och bruksanvisning
- Istruzioni di montaggio e uso
- Instrucciones de montaje y empleo
- 取扱説明書



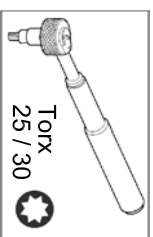

H	L
800	/
1000	250
1200	325
1400	375
1600	450
1800	525
2000	575

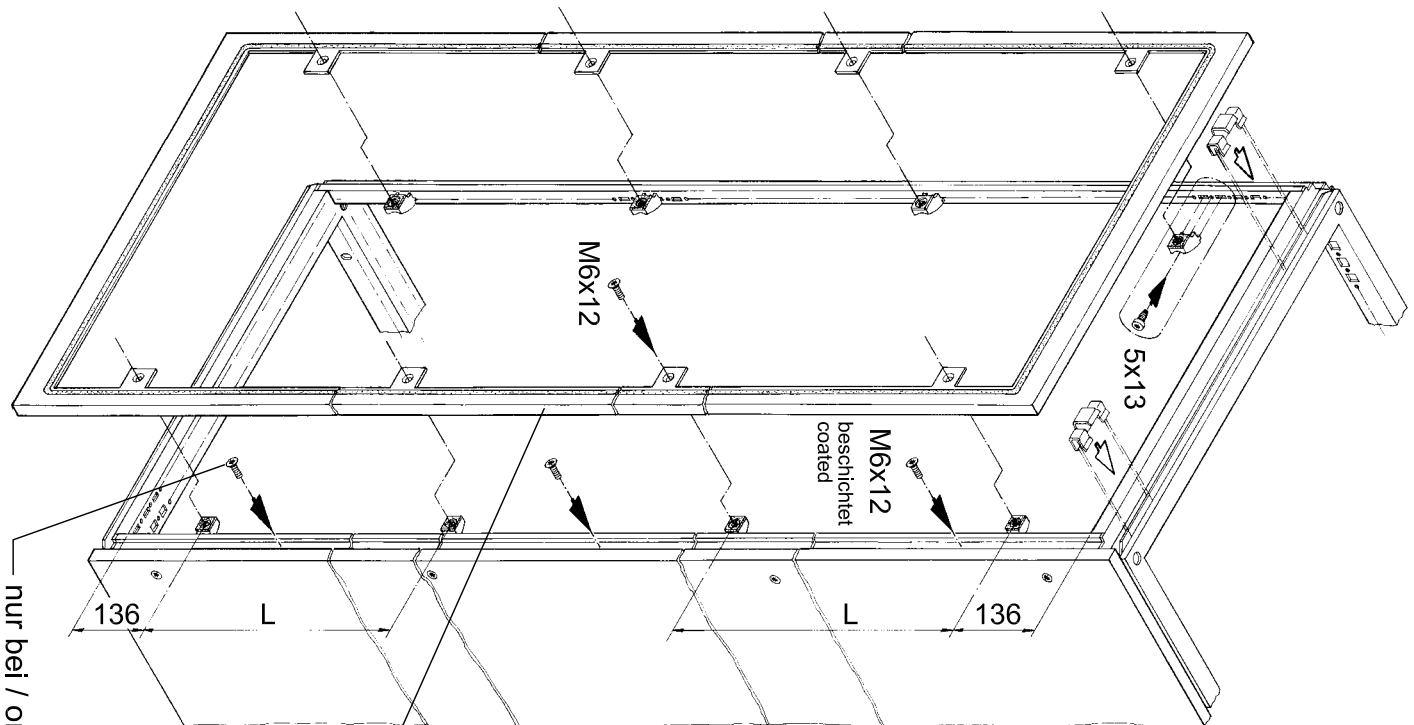

Anreihrahmen
 Baying frame
 Armature de raccordement
 Verbindend kader
 Föbbindingsram
 Struttura di collegamento
 Marco de conexión

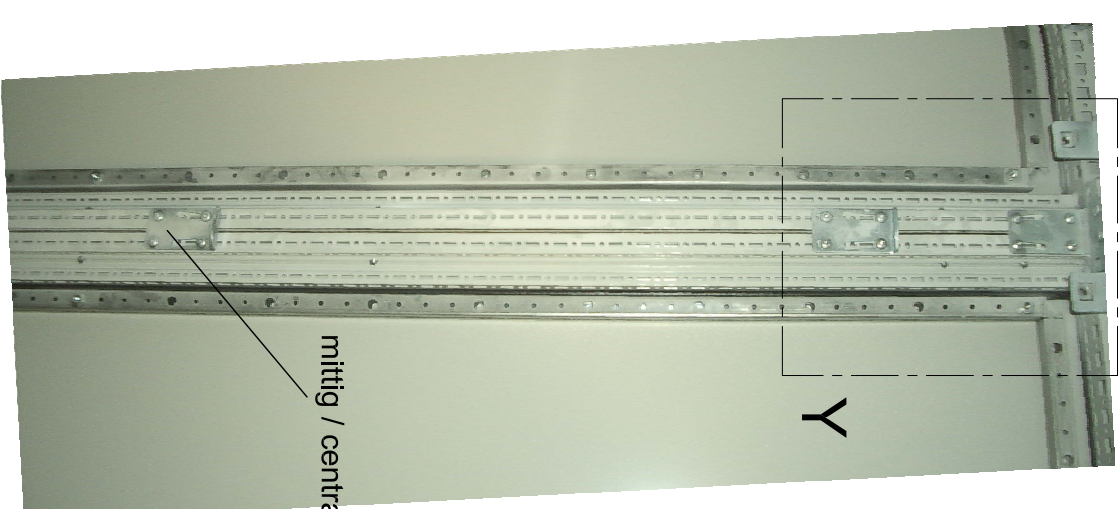
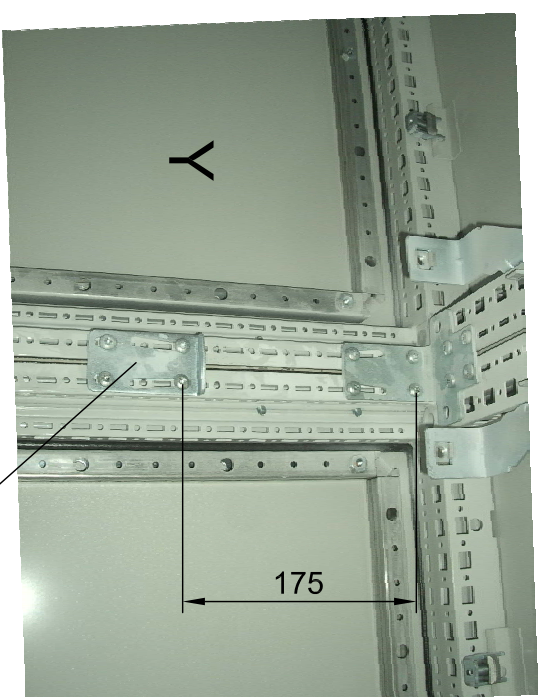
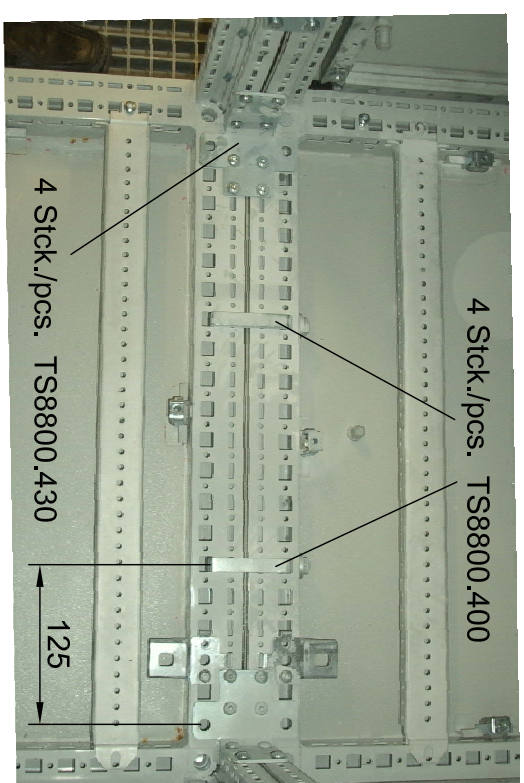
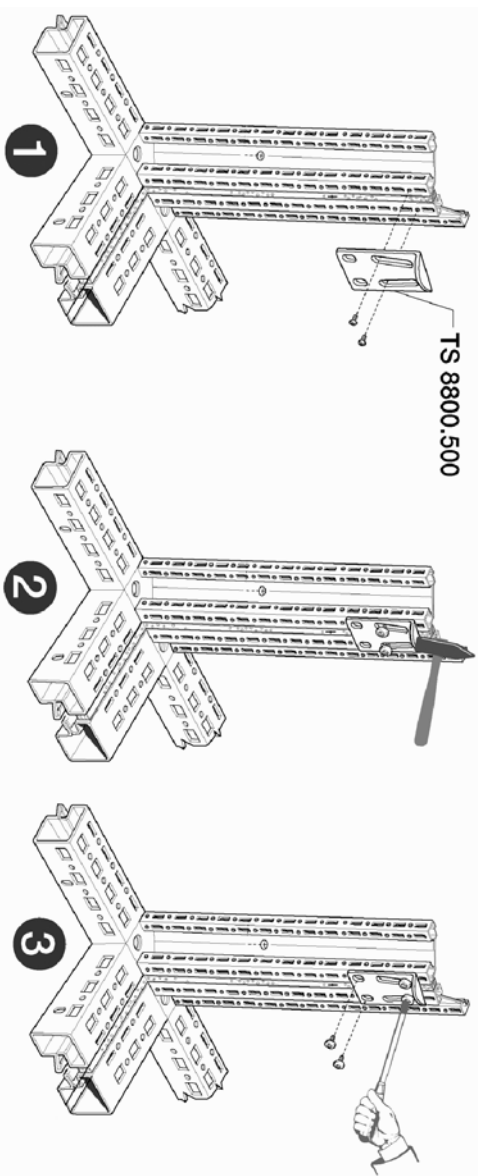

6 Stck./pcs. TS8800.500

