

CP
6141.200

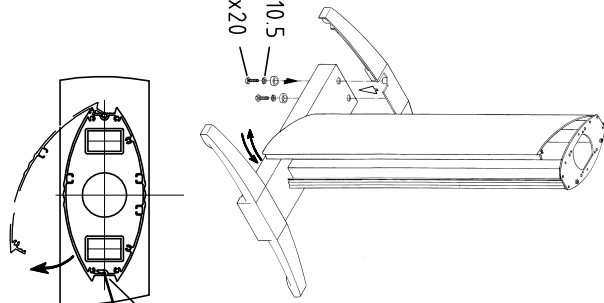

Raum für Verpackungsdatum
Area for date of packing
(MMJJTT / MMYYYDD)

A 10.5
M 10x20



1

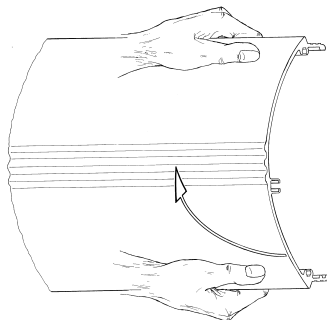
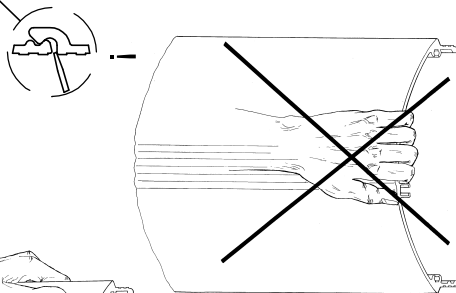

M6

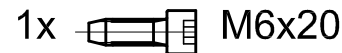

M6x20

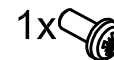

M6x12



M8x20



A 10.5



J8.4



A 6.4



Ø6.1

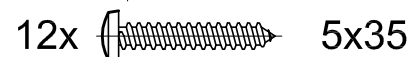
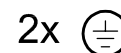

5x35

Zchnng.-Nr. / No. of dwg. : A2749902CP

Versandbeutel-Nr. / No. of accessory bag : 285086

Lieferanten-Nr. / No. of supplier :

