

Rittal – The System.

Faster – better – everywhere.

**Ri4Power System 185 mm –
Berührungsschutzabdeckung IP2X**

**Ri4Power system 185 mm –
Contact hazard protection cover IP2X**

**Ri4Power système 185 mm –
Plastron de protection IP2X**

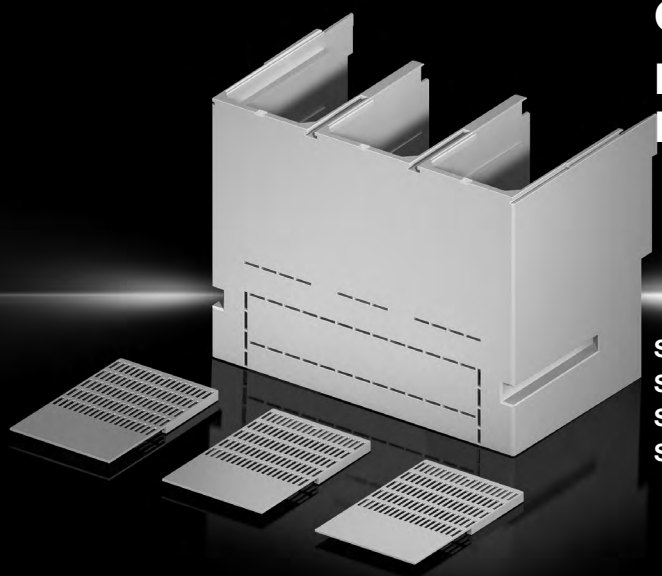

SV 9677.790

SV 9677.792

SV 9677.794

SV 9677.798

Montageanleitung

Assembly instructions

Notice de montage

ENCLOSURES

POWER DISTRIBUTION

CLIMATE CONTROL

IT INFRASTRUCTURE

SOFTWARE & SERVICES

FRIEDHELM LOH GROUP



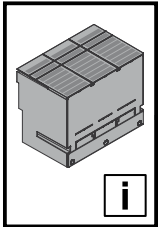

Inhaltsverzeichnis
Contents
Sommaire

DE

1. Hinweise zur Dokumentation	3
1.1 CE-Kennzeichnung	3
1.2 Aufbewahrung der Unterlagen	3
1.3 Verwendete Symbole	3
1.4 Mitgeltende Unterlagen	3
2. Sicherheitshinweise	4
3. Montage	9
4. Lagerung	11

EN

1. Notes on documentation	3
1.1 CE labelling	3
1.2 Storing the documents	3
1.3 Symbols used	3
1.4 Other applicable documents	3
2. Safety instructions	4
3. Assembly	9
4. Storage	11

FR

1. Remarques relatives à la documentation	3
1.1 Certification CE	3
1.2 Conservation des documents	3
1.3 Symboles utilisés	3
1.4 Autres documents applicables	3
2. Consignes de sécurité	4
3. Montage	9
4. Stockage	11

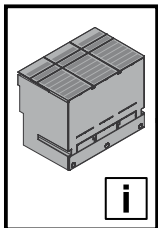

1. Hinweise zur Dokumentation
1. Notes on documentation
1. Remarques relatives à la documentation

DE

Die Montageanleitung richtet sich an alle Personen, die über eine entsprechende Fachausbildung verfügen, um Schaltschränke normgerecht mit elektrischen, elektronischen, mechanischen oder pneumatischen Betriebsmitteln auszurüsten, am Bestimmungsort aufzustellen bzw. zu montieren und betriebsfertig anzuschließen.
 Die originale Montageanleitung ist in deutscher Sprache verfasst.

1.1 CE-Kennzeichnung

Die Konformitätserklärung steht als Download auf der Homepage von Rittal zur Verfügung.

1.2 Aufbewahrung der Unterlagen

Diese Montageanleitung ist Bestandteil des ausgelieferten Produktes. Sie muss für den Installateur, Instandhalter, Nutzer und das Reinigungspersonal jederzeit gut erreichbar in der Nähe des Produktes aufbewahrt werden.

1.3 Verwendete Symbole

Beachten Sie folgende Sicherheits- und sonstige Hinweise in der Anleitung:

Symbol für eine Handlungsanweisung:

- Der Blickfangpunkt zeigt an, dass Sie eine Handlung durchführen sollen.

Sicherheits- und andere Hinweise:



Gefahr!

Unmittelbare Gefahr für Leib und Leben.



Achtung!

Mögliche Gefahr für Produkt und Umwelt.



Hinweis:

Nützliche Information und Besonderheiten.



1.4 Mitgeltende Unterlagen

Für die hier beschriebenen Sammelschienen-Komponenten steht diese Montageanleitung als Download unter www.rittal.de zur Verfügung. Für Schäden, die durch Nichtbeachtung dieser Anleitung entstehen, übernehmen wir keine Haftung. Zusätzlich gelten auch die Anleitungen des verwendeten Zubehörs.

EN

The assembly instructions are aimed at all persons who have an appropriate specialist training to allow them to equip enclosures to conform to standards with electrical, electronic, mechanical or pneumatic operating equipment, to place or install at the destination site and to connect ready to operate.
 The original assembly instructions are written in German.

1.1 CE labelling

The declaration of conformity can be downloaded from the Rittal website.

1.2 Storing the documents

These assembly instructions are part of the delivered product. They must be stored for the installation engineer, operator, maintenance and cleaning personnel in any easily accessible location near the product.

1.3 Symbols used

Observe the following safety and other notes in the instructions:

Symbol identifying required actions:

- The bullet point indicates an action to be performed.

Safety and other notes:



Danger!

Immediate danger to life and limb.



Caution!

Potential threat to the product and its environment.



Note:

Useful information and special features.



1.4 Other applicable documents

These assembly instructions for the described busbar components can be downloaded from www.rittal.com. We cannot accept any liability for damage associated with failure to observe these instructions. The instructions for any accessories used also apply.

FR

La notice de montage s'adresse à toutes les personnes qui possèdent les compétences professionnelles correspondantes, pour équiper les armoires électriques avec du matériel électrique, électronique, mécanique ou pneumatique dans le respect des normes, pour les mettre en place ou les monter sur le lieu d'exploitation.

La notice de montage originale est rédigée en allemand.

1.1 Certification CE

La déclaration de conformité est disponible pour téléchargement sur le site internet de Rittal.

1.2 Conservation des documents

La présente notice de montage fait partie intégrante du produit fourni. Elle doit être conservée à proximité du produit et être facilement accessible à tout moment au personnel d'installation, de maintenance, d'exploitation et de nettoyage.

1.3 Symboles utilisés

Tenir compte des consignes de sécurité et autres directives contenues dans cette notice :

Symbole indiquant une action à effectuer :

- Le pictogramme en caractère gras indique que vous devez exécuter une action.

Consignes de sécurité et autres directives :



Danger !

Risque de blessure grave, voire mortelle.



Attention !

Danger éventuel pour le produit et l'environnement.



Remarque :

Informations utiles et particularités.



1.4 Autres documents applicables

La présente notice de montage pour les composants du jeu de barres décrites ici peut être téléchargée sur le site internet www.rittal.fr. Nous déclinons toute responsabilité en cas de dommages imputables à la non-observation des instructions contenues dans ces documents. Veuillez également tenir compte des instructions relatives aux accessoires utilisés.

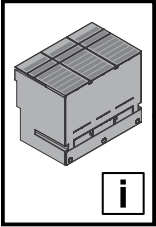

2. Sicherheitshinweise
2. Safety instructions
2. Consignes de sécurité

DE



Vor Installation- oder Servicearbeiten Stromversorgung unterbrechen, um Unfälle zu vermeiden. Die Geräte müssen in einem passenden Gehäuse eingebaut und gegen Verschmutzung geschützt werden. Inbetriebsetzung und Wartung nur durch Fachpersonal!

EN



To prevent electric shock, disconnect from power source before installing or servicing. Install in suitable enclosure. Keep free from contaminants. To be commissioned and maintained only by qualified personnel!

FR



Avant le montage et la mise en service, couper l'alimentation secteur afin d'éviter tout accident. Prévoir un coffret ou une armoire électrique approprié pour intégrer les appareils qui les protège contre la saleté. La mise en service et l'entretien doivent être effectués uniquement par du personnel qualifié !

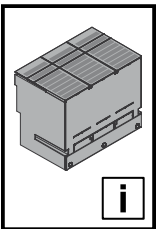

Sicherheitshinweise
Safety instructions
Consignes de sécurité





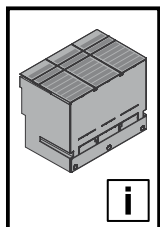

Veiligheidsvoorschriften
Säkerhetsinstruktioner

	DE	EN	FR	NL	SE
	Warnung vor sich bewegenden mechanischen Teilen	Warning against independently moving parts	Danger dû à des pièces mécaniques mobiles	Waarschuwing voor bewegende mechanische onderdelen	Varning för rörliga mekaniska delar
	Warnung vor spitzem Gegenstand	Caution: Sharp object	Attention aux objets pointus	Waarschuwing voor scherpe voorwerpen	Varning för vassa föremål
	Warnung vor gefährlicher elektrischer Spannung	Warning – dangerous electrical voltage	Attention tension électrique dangereuse !	Waarschuwing voor gevaarlijke elektrische spanning	Varning för farlig elektrisk spänning
	Die Anleitung ist zu lesen	The instructions must be read	La notice doit être lue	Lees de gebruiksaanwijzing	Bruksanvisningen måste läsas
	Vor Wartung oder Reparatur freischalten	Disconnect before carrying out maintenance or repair	Avant toute intervention pour maintenance ou réparation, couper le courant	Voor onderhoud of reparatie uitschakelen	Kopplas bort innan underhåll eller reparationer utförs
	Installation durch Elektro-Fachkraft	Installation by specialist electricians	Installation par un électricien confirmé	Installatie door elektro-technisch personeel	Ska installeras av behörig elektriker



Istruzioni di sicurezza
Instrucciones de seguridad
Turvallisuusohjeet

Sikkerhedsanvisninger
Wskazówki dotyczące bezpieczeństwa

	IT	ES	FI	DK	PL
	Prestare attenzione alle parti meccaniche in movimento	Atención, componentes mecánicos en movimiento	Varoitus liikkuvista mekaanisista osista	Advarsel mod uafhængigt bevægelige dele	Uwaga na ruchome części mechaniczne
	Pericolo oggetto affilato	Advertencia de objetos puntiagudos	Varo teräviä reunoja	Advarsel: Spidse genstande	Ostrzeżenie przed ostrym przedmiotem
	Pericolo corrente elettrica	Riesgo de descarga eléctrica	Varoitus vaarallisesta sähköjännitteestä	Farlig elektrisk spænding	Ostrzeżenie przed niebezpiecznym napięciem elektrycznym
	Leggere le istruzioni	Leer el manual de instrucciones	Lue käyttöohjeet	Vejledningen skal læses	Przeczytać instrukcję
	Scollegare prima di eseguire interventi di manutenzione o riparazione	Desconectar antes de mantenimiento o reparación	Lukitus avattava ennen huoltoa tai korjausta	Skabet skal frakoble alt strøm inden vedligeholdelse eller reparationer udføres.	Rozłącz przed wykonawanie przeglądu lub naprawy
	L'installazione deve essere eseguita da un elettricista qualificato	Instalación a realizar por un técnico electricista cualificado	Asennuksen saa suorittaa vain sähköalan ammattilainen	Skal installeres af uddannet elektriker	Instalacja przez elektryka

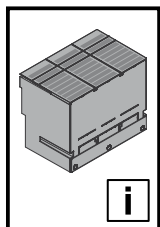

Bezpečnostní pokyny
Инструкции за безопасност
Меры безопасности

Υποδείξεις ασφαλείας
Instrucțiuni de siguranță

	CZ	BG	RU	GR	RO
	Výstraha; Rozmačkání	Предупреждение за движещи се механични части	Предупреждение об опасности движущихся механических частей	Προειδοποίηση από κινούμενα μηχανικά μέρη	Avertisment cu privire la piesele mecanice aflate în mișcare
	Varování před ostrým předmětem	Предупреждение за опасност от остър предмет	Предупреждение об остром предмете	Προειδοποίηση αιχμηρού αντικειμένου	Avertizare privind obiecte ascuțite
	Výstraha před nebezpečným elektrickým napětím	Опасност! Високо напрежение	Предупреждение об опасном электрическом напряжении	Προειδοποίηση για επικίνδυνη ηλεκτρική τάση	Avertizare privind tensiunea electrică periculoasă
	Odkaz na instrukce návodu k použití/ brožury	Прочетете ръководството	Прочитать руководство	Απαιτείται το διάβασμα των οδηγιών	A se citi manualul
	Před prováděním údržby nebo oprav odpojte zařízení	Изключете преди извършване на поддръжка или ремонт	Отключить перед обслуживанием и ремонтом	Αποσυνδέστε πριν εκτελέσετε συντήρηση ή επισκευές	Deconectați înainte de a efectua lucrări de întreținere sau reparații
	Instalace vyžaduje elektro odbornost	Монтажът се извършва от електротехник	Установка силами специалистов по электрике	Εγκατάσταση από εκπαιδευμένο ηλεκτρολόγο	Instalarea se va face de un electrician calificat

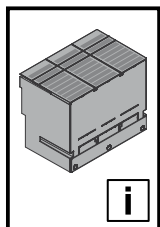





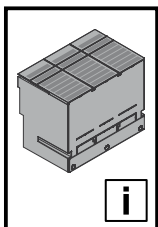

**Sigurnosne upute
Biztonsági utasítások
Saugos nurodymai**

**Ohutusjuhised
Drošības norādījumi**

	HR	HU	LT	EE	LV
	Upozorenje na mehaničke dijelove koji su u pokretu	Mozgó mechanikai részekre történő figyelmeztetés	Įspėjimas dėl judančių mechaninių dalių	Hoiatus liikuvate mehhaaniliste osade eest	Uzmanieties no kustīgām mehāniskām daļām
	Opasnost od sječiva	Figyelmeztetés hegyes tárgyak veszélyére	Įspėjimas apie aštrų daiktą	Hoiatus terava eseme eest	Brīdinājums par asiem priekšmetiem
	Upozorenje na opasni električni napon	Figyelem! Elektromos feszültség	Įspėjimas apie pavojingą elektros įtampą	Hoiatus ohtliku elektripinge eest	Brīdinājums par bīstamu elektrisko spriegumu
	Pročitajte upute	Az utasítást el kell olvasni	Skaityti instrukciją	Lugeda kasutusjuhendit	Izlasiet instrukciju
	Isključiti prije održavanja ili popravka	Karbantartás vagy javítás előtt kapcsolja k	Prieš atlikdami techninę priežiūrą ar remontą, atjunkite	Lahtiühendamise enne hooldus- või remonditööde tegemist	Atvienojiet pirms apkopes vai remonta veikšanas
	Instalaciju smije provesti samo ovlašteno stručno osoblje za električarske radove	A szerelést elektromos szakembernek kell elvégeznie	Turi įrengti elektrikas	Kvalifitseeritud elektrikui poolne paigaldamine	Uzstādīšanu drīkst veikt tikai kvalificēts elektriķis



Varnostni napotki
Bezpečnostné pokyny
Instruções de segurança

	SI	SK	PT
	Opozorilo pred premikajočimi se mehanskimi deli	Dávajte pozor na pohyblivé mechanické časti	Cuidado com as partes mecânicas móveis
	Opozorilo pred ostrim predmetom	Varovanie pred predmetom s ostrým hrotom	Cuidado com objetos pontiagudos
	Opozorilo za nevarno električno napetost	Nebezpečnostvo úrazu elektrinou	Aviso de perigo de tensão elétrica
	Preberite navodila	Prečítajte si návod	Ler as instruções
	Izključite pred zdrževanjem ali popravili	Pred vykonaním údržby alebo opráv odpojte zariadenie od elektrickej sieti	Desconecte antes de executar manutenção ou reparos
	Namestitvev lahko izvajajo samo usposobljeni strokovnjaki za elektrotehnična dela	Inštaláciu smie vykonávať len špecializovaný elektrotechnik	A instalação deve ser feita por um técnico eletrícista especializado

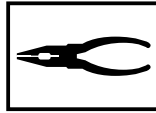
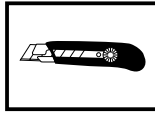
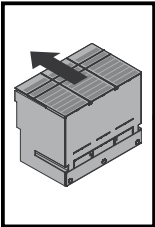

3. Montage
3. Assembly
3. Montage

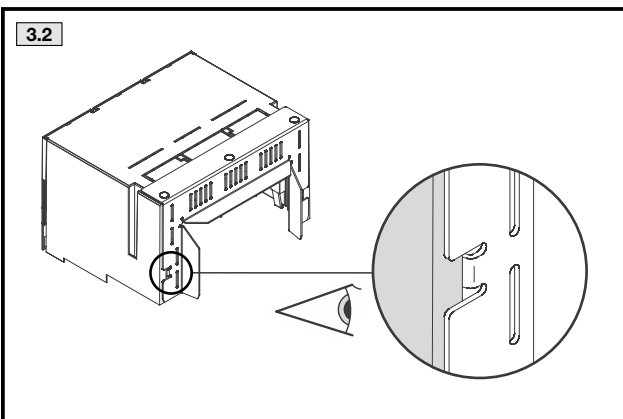
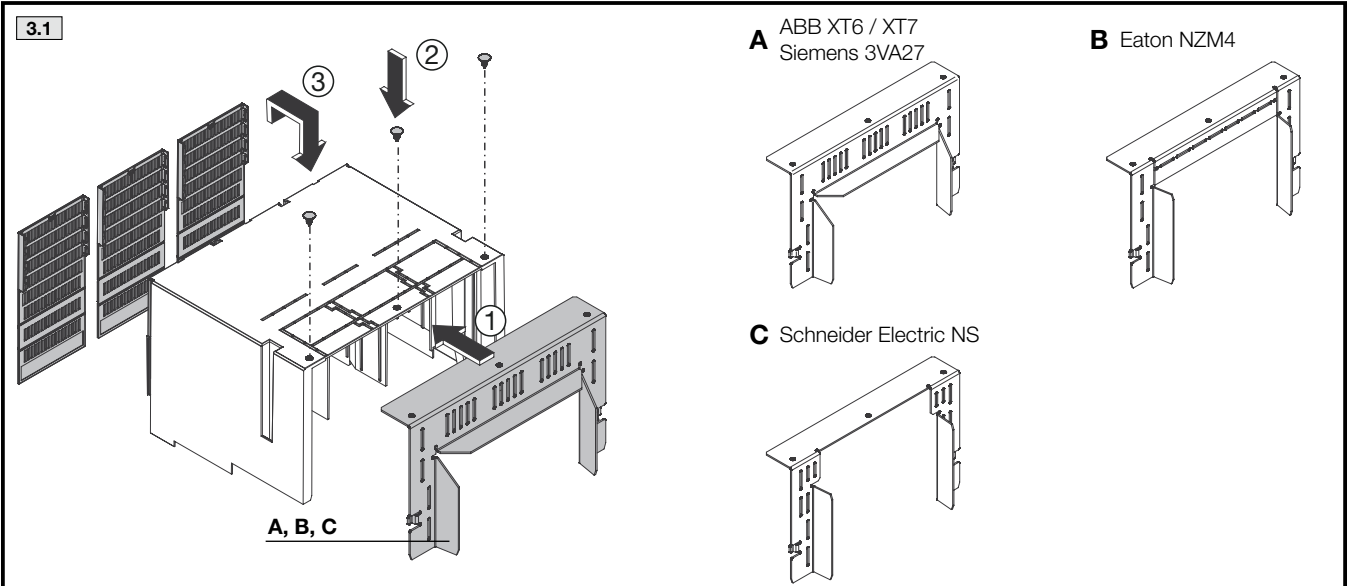
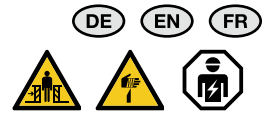

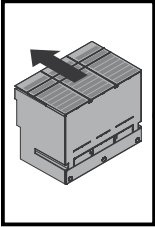

3. Montage
3. Assembly
3. Montage

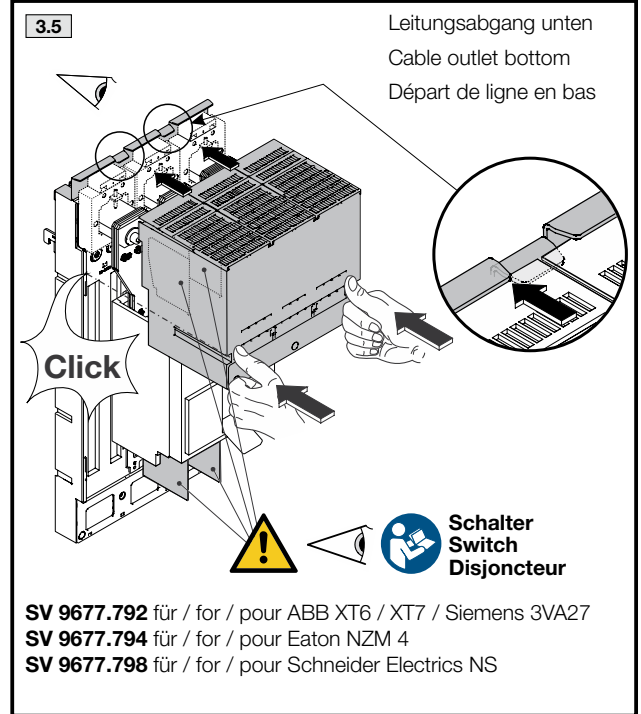
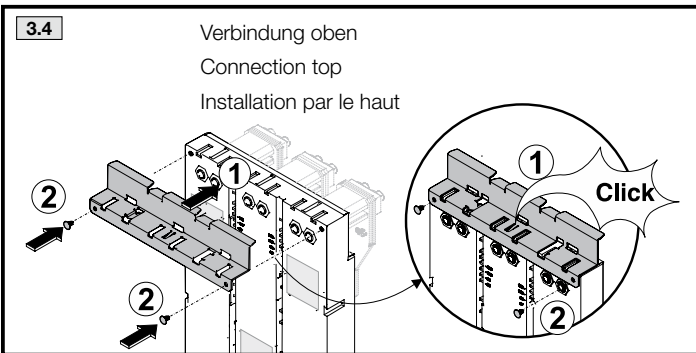
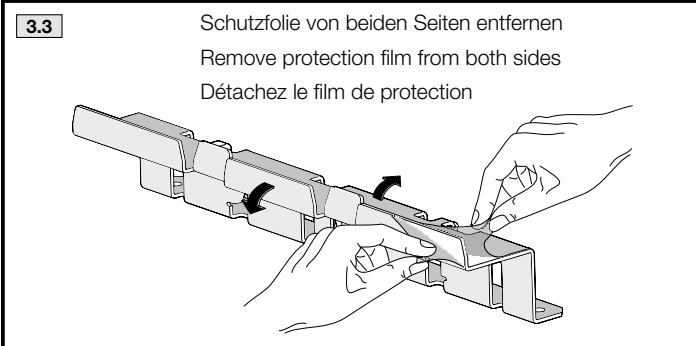

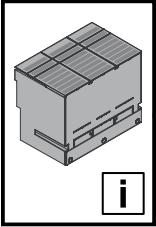

4. Lagerung

4. Storage

4. Stockage

DE

Bei der Lagerung dieser Komponenten ist zu beachten, dass

- die Umgebungstemperatur nicht höher als +70 °C ist.
- die Umgebungstemperatur nicht niedriger als -25 °C ist.
- die relative Luftfeuchte zwischen 10 % und 95 %, nicht kondensierend, liegt.

EN

When storing these components, ensure that

- the ambient temperature is not higher than +70 °C.
- the ambient temperature is not lower than -25 °C.
- the relative humidity lies between 10% and 95% (non-condensing).

FR

Lors du stockage de ces composants, il faut veiller à ce que

- la température ambiante ne soit pas supérieure à +70 °C.
- la température ambiante ne soit pas inférieure à -25 °C.
- l'humidité relative de l'air se situe entre 10 % et 95 % (sans condensation)

Rittal – The System.

Faster – better – everywhere.

- Enclosures
- Power Distribution
- Climate Control
- IT Infrastructure
- Software & Services

You can find the contact details of all Rittal companies throughout the world here.



www.rittal.com/contact

RITTAL GmbH & Co. KG
Auf dem Stuetzelberg · 35745 Herborn · Germany
Phone +49 2772 505-0
E-mail: info@rittal.de · www.rittal.com

01.2023/D-0000-00000545-02

ENCLOSURES

POWER DISTRIBUTION

CLIMATE CONTROL

IT INFRASTRUCTURE

SOFTWARE & SERVICES

FRIEDHELM LOH GROUP

