

**Rittal – The System.**

Faster – better – everywhere.

# Hygienic Design

Extra cleanliness guaranteed

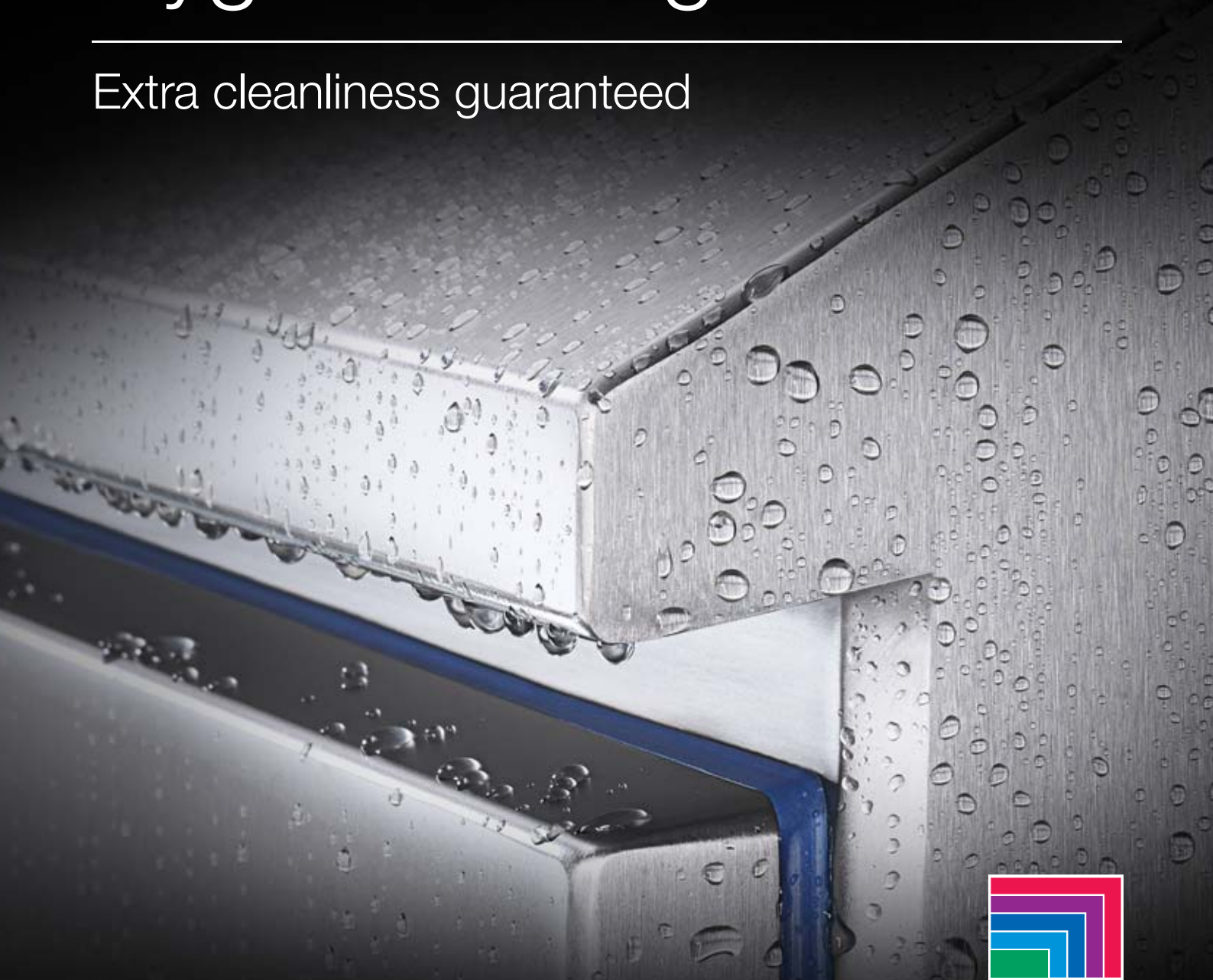

ENCLOSURES

POWER DISTRIBUTION

CLIMATE CONTROL

IT INFRASTRUCTURE

SOFTWARE & SERVICES



FRIEDHELM LOH GROUP

# Rittal – The System.

Faster – better – everywhere.

## Climate control outside the hygiene zone

It supplies the air/water heat exchangers in the hygiene zone and the LCP in the data centre with the required cooling water.

## Open processes in the hygiene zone

Practical housings designed for ease of cleaning to ensure optimum hygiene in the production area

ENCLOSURES

POWER DISTRIBUTION

CLIMATE CONTROL

# One-stop solution for optimum processes

All areas of the food industry require different hygiene standards. Rittal has the right solution for everything, from the housing and the power distribution to the climate control – everything is a perfect match. Naturally, the IT infrastructure is no exception.

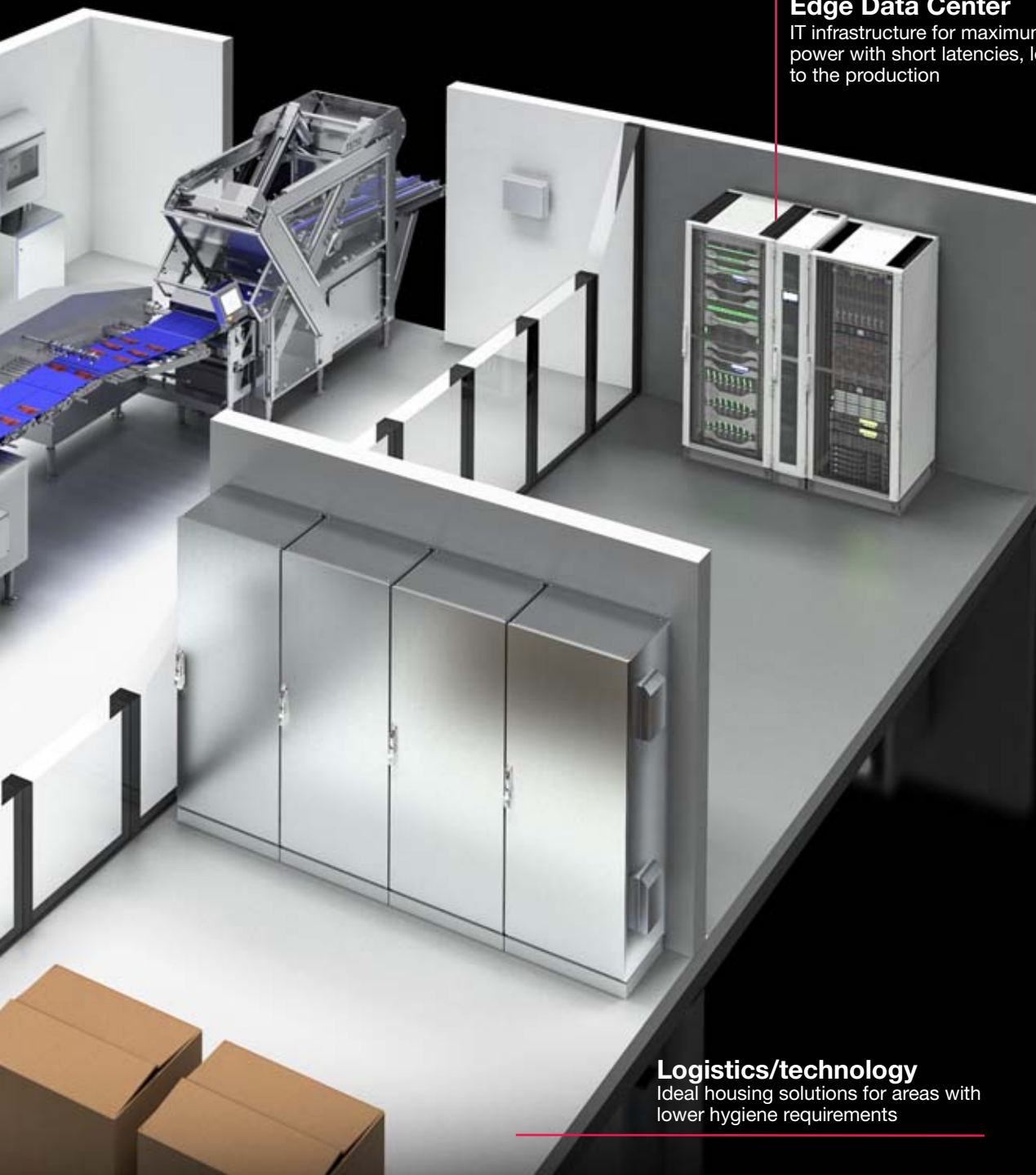

## Edge Data Center

IT infrastructure for maximum computing power with short latencies, located close to the production

## Logistics/technology

Ideal housing solutions for areas with lower hygiene requirements

IT INFRASTRUCTURE

SOFTWARE & SERVICES



# Hygiene standards for high productivity and reliability

“Rittal – The System.” stands for cleverly thought-out system solutions for hygienic production in the food industry. Particularly in open processes, where the resistance of the seal to detergents and disinfectants is crucial, it is vital for production plant to be equipped with optimised enclosures, terminal boxes and command panels.



## The Rittal Hygienic Design for food safety is based on:

### European standards and directives

- EN 1672-2:2020 Food machinery/General design principles/Part 2: Hygiene requirements
- EN ISO 14 159 Safety of machinery – Hygiene requirements for the design of machinery
- EN 16001:2009-06 Energy management to improve energy efficiency
- Machinery directive 2006/42/EC binding – Annex 1, section 2.1: Foodstuffs machinery and machinery for cosmetics or pharmaceutical products
- Document 13 EHEDG guideline on the hygienic design of apparatus for open processes, prepared in collaboration with 3-A and NSF International, as well as Document 8 EHEDG – Hygienic Equipment Design Criteria

### EU regulations

- 852/2004 on the hygiene of foodstuffs
- 853/2004 specific hygiene rules for food of animal origin
- 854/2004 specific rules for the organisation of official controls on products of animal origin intended for human consumption
- 1935/2004 on materials and articles intended to come into contact with food

### FDA-compliant seal

- The FDA (Food and Drug Administration) Directive 21 CFR 177.2600 in the USA regulates the use of “rubber products intended for repeated use”.

Decide for yourself what is important.

### Rittal Hygienic Design boosts operational hygiene

- Reduces the use of C&D agents
- Optimises cleaning results
- Ensures higher productivity
- Minimises risks
- Increases energy efficiency (CO<sub>2</sub> footprint)

The cULus listed approval applies to HD switch housings, HD terminal boxes, HD compact enclosures and HD system enclosures.



# Extra cleanliness guaranteed!

Terminal boxes, switch housings and compact enclosures in Hygienic Design (HD) are key elements in the design of open processes in the food industry and clean rooms due to their ease of cleaning. Compatible accessories such as wall spacer brackets and HD-compatible cable glands complete the range. If you have specific requirements, "Rittal – The System." is sure to have the right solution.



## HD terminal boxes and HD switch housings

### Silicone seal

- All-round external joint-free silicone seal
- Easy to replace
- Guides and fixes the lid to the screw fasteners
- All-round tilt for terminal boxes and switch housings
  - Enclosure: 3°
  - Lid: 10°

### Screw fastener

- Captive
- With external seal
- Hexagon shape for perfect cleanliness

### Interior installation

- Mounting hole pitch pattern of 6.25 mm for greater flexibility
- Support rails and mounting plates of the terminal box may be directly fitted

## Compact enclosures HD

### Hinges and seal

- Hinges that are inside the sealing zone create an exceptionally easy-clean design on the outside
- The durable all-round, external silicone seal is joint-free
- Installed sealing frames are easily replaced
- No external cavity between enclosure and door
- Seal dyed blue to clearly distinguish it from foodstuffs

### Lock and lock insert

- External parts made of stainless steel
- Material and shape allow easy and reliable cleaning

### Roof, tilted

- 30° tilt on compact enclosures prevents objects from being deposited on it
- Easily inspected
- Allows fluids to drain off rapidly



# Hygienic Design



## HD accessories from page 23

### Design:

- Enclosure angled forwards by 3°

### Material:

- Enclosure and cover: Stainless steel 1.4301 (AISI 304) 1.5 mm
- Screw plug: Stainless steel
- Seal: Silicone, compliant with FDA Guideline 21 CFR 177.2600

### Surface finish:

- Enclosure and cover: Brushed, grain 400, peak-to-valley height < 0,8 µm
- Seal: Blue, dyed (RAL 5010)

### Protection category IP to IEC 60 529:

- IP66
- IPX9

### Type rating to UL 50E:

- Type 1, 3, 3X, 4, 4X, 12, 13

### Supply includes:

- Enclosure of all-round solid construction
- Cover with switch cut-out
- Seal and screw plug (supplied loose)

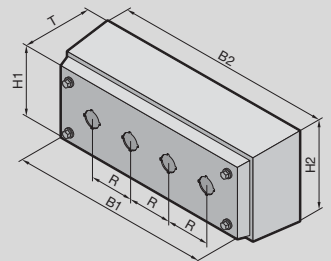

## Switch housing HD

<b>Width front (B1) mm</b>	Packs of	100	100	100	100	160	Page
<b>Width rear (B2) mm</b>		122	122	122	122	182	
<b>Height front (H1) mm</b>		100	160	220	280	220	
<b>Height rear (H2) mm</b>		122	182	242	302	242	
<b>Depth (T) mm</b>		90	90	90	90	90	
Pitch pattern (R) mm		-	60	60	60	60	
No. of switch cut-outs Ø 22.5 mm		1	2	3	4	6	
Weight kg		0.98	1.3	1.62	1.98	2.12	
<b>Model No.</b>	1 pc(s).	<b>1681.600</b>	<b>1682.600</b>	<b>1683.600</b>	<b>1684.600</b>	<b>1686.600</b>	
<b>Accessories</b>							
Wall spacer bracket HD	1 pc(s).	4000.100	4000.100	4000.100	4000.100	4000.100	25
Cable gland HD		see page	see page	see page	see page	see page	29
Pressure relief stoppers, stainless steel	5 pc(s).	4000.300	4000.300	4000.300	4000.300	4000.300	23
Earth straps	5 pc(s).	2565.100	2565.100	2565.100	2565.100	2565.100	Cat. 36, 1033



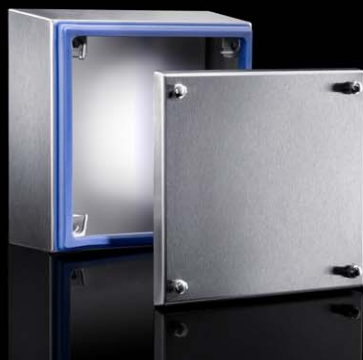

## HD accessories from page 23

### Design:

- Enclosure angled forwards by 3°

### Material:

- Enclosure and cover: Stainless steel 1.4301 (AISI 304) 1.5 mm
- Mounting bracket: Sheet steel, zinc-plated, passivated, 2.0 mm
- Screw plug: Stainless steel
- Seal: Silicone, compliant with FDA Guideline 21 CFR 177.2600

### Surface finish:

- Enclosure and cover: Brushed, grain 400, peak-to-valley height < 0.8 µm
- Seal: Blue, dyed (RAL 5010)

### Protection category IP to IEC 60 529:

- IP66
- IPX9

### Type rating to UL 50E:

- Type 1, 3, 3X, 4, 4X, 12, 13

### Supply includes:

- Enclosure of all-round solid construction
- Cover
- Mounting bracket (pre-assembled)
- Seal and screw plug (supplied loose)

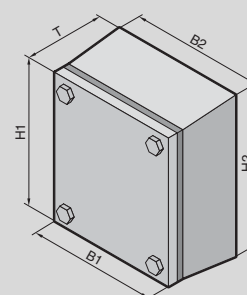

## Terminal boxes HD

Width front (B1) mm	Packs of	150	150	200	300	400	400	Page
Width rear (B2) mm		172	177	227	327	427	427	
Height front (H1) mm		150	150	200	200	200	300	
Height rear (H2) mm		172	177	227	227	227	327	
Depth (T) mm		80	120	120	120	120	120	
Weight kg		1.7	2.2	3.0	4.0	5.0	5.9	
<b>Model No.</b>	1 pc(s).	<b>1670.600</b>	<b>1671.600</b>	<b>1672.600</b>	<b>1674.600</b>	<b>1675.600</b>	<b>1676.600</b>	
<b>Accessories</b>								
Wall spacer bracket HD	1 pc(s).	4000.100	4000.100	4000.100	4000.100	4000.100	4000.100	25
Mounting plate	1 pc(s).	1560.800	1560.800	1562.800	1563.800	1564.800	1568.800	Cat. 36, 970
Support rail TS 35/7.5	10 pc(s).	2314.000	2314.000	2315.000	2316.000	2317.000	2317.000	Cat. 36, 997
Cable gland HD		see page	see page	see page	see page	see page	see page	29
Pressure relief stoppers, stainless steel	5 pc(s).	4000.300	4000.300	4000.300	4000.300	4000.300	4000.300	23

# Hygienic Design



**HD accessories** from page 23

## Design:

- Roof angled forwards by 30°

## Material:

- Enclosure and door: Stainless steel 1.4301 (AISI 304)
- Mounting plate: Sheet steel
- Lock insert HD: Stainless steel 1.4404 (AISI 316L)
- Seal: Silicone, compliant with FDA Guideline 21 CFR 177.2600

## Surface finish:

- Enclosure and door: Brushed, grain 400, peak-to-valley height < 0.8 µm
- Mounting plate: Zinc-plated
- Seal: Blue, dyed (RAL 5010)

## Protection category IP to IEC 60 529:

- IP66
- IPX9

## Type rating to UL 50E:

- Type 1, 3, 3X, 4, 4X, 12, 13

## Supply includes:

- Enclosure of all-round solid construction
- Door with inserted seal
- Door hinged on the right, may be swapped to the left
- Mounting plate

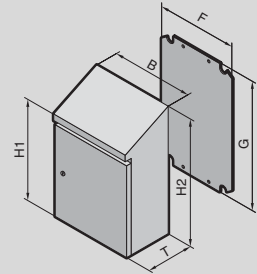

## Compact enclosure HD, single-door

Width (B) mm	Packs of	220	310	390	390	390	Page
Height front (H1) mm		350	430	550	430	650	
Height rear (H2) mm		437	549	669	549	769	
Depth (T) mm		155	210	210	210	210	
Mounting plate width (F) mm		160	250	330	330	330	
Mounting plate height (G) mm		275	355	475	355	575	
Weight kg		6.6	11.0	15.5	14.7	17.9	
<b>Model No.</b>	1 pc(s).	<b>1302.600</b>	<b>1304.600</b>	<b>1305.600</b>	<b>1306.600</b>	<b>1308.600</b>	
<b>Accessories</b>							
Wall spacer bracket HD	1 pc(s).	4000.100	4000.100	4000.100	4000.100	4000.100	25
Cable gland HD		see page	see page	see page	see page	see page	29
Rail for interior installation	4 pc(s).	–	–	–	–	5001.050	29
T handle HD without lock	1 pc(s).	4000.065	4000.065	4000.065	4000.065	4000.065	24
T handle, stainless steel with cylinder insert, lock no. 333	1 pc(s).	4000.067	4000.067	4000.067	4000.067	4000.067	24
Bit HD	1 pc(s).	2549.510	2549.510	2549.510	2549.510	2549.510	25
Enclosure key HD	1 pc(s).	2549.500	2549.500	2549.500	2549.500	2549.500	24
Pressure relief stoppers, stainless steel	5 pc(s).	4000.300	4000.300	4000.300	4000.300	4000.300	23

## Compact enclosure HD, single-door

Width (B) mm	Packs of	510	610	610	610	610	Page
Height front (H1) mm		550	810	650	650	430	
Height rear (H2) mm		669	981	821	769	601	
Depth (T) mm		210	300	300	210	300	
Mounting plate width (F) mm		450	550	550	550	550	
Mounting plate height (G) mm		475	735	575	575	355	
Weight kg		19.7	38.0	31.0	27.4	21.7	
<b>Model No.</b>	1 pc(s).	<b>1307.600</b>	<b>1312.600</b>	<b>1311.600</b>	<b>1310.600</b>	<b>1320.600</b>	
<b>Accessories</b>							
Wall spacer bracket HD	1 pc(s).	4000.100	4000.100	4000.100	4000.100	4000.100	25
Cable gland HD		see page	see page	see page	see page	see page	29
Rail for interior installation	4 pc(s).	–	5001.050	5001.050	5001.050	–	29
T handle HD without lock	1 pc(s).	4000.065	4000.065	4000.065	4000.065	4000.065	24
T handle, stainless steel with cylinder insert, lock no. 333	1 pc(s).	4000.067	4000.067	4000.067	4000.067	4000.067	24
Bit HD	1 pc(s).	2549.510	2549.510	2549.510	2549.510	2549.510	25
Enclosure key HD	1 pc(s).	2549.500	2549.500	2549.500	2549.500	2549.500	24
Pressure relief stoppers, stainless steel	5 pc(s).	4000.300	4000.300	4000.300	4000.300	4000.300	23

## Compact enclosure HD, single-door

Width (B) mm	Packs of	810	810	810	810	Page
Height front (H1) mm		430	650	1050	1250	
Height rear (H2) mm		549	821	1221	1421	
Depth (T) mm		210	300	300	300	
Mounting plate width (F) mm		750	750	745	745	
Mounting plate height (G) mm		355	575	975	1175	
Weight kg		25.5	39.0	60.1	71.0	
<b>Model No.</b>	1 pc(s).	<b>1314.600</b>	<b>1315.600</b>	<b>1316.600</b>	<b>1317.600</b>	
<b>Accessories</b>						
Wall spacer bracket HD	1 pc(s).	4000.100	4000.100	4000.100	4000.100	25
Cable gland HD		see page	see page	see page	see page	29
Rail for interior installation	4 pc(s).	–	5001.050	5001.050	5001.050	29
T handle HD without lock	1 pc(s).	4000.065	4000.065	4000.065	4000.065	24
T handle, stainless steel with cylinder insert, lock no. 333	1 pc(s).	4000.067	4000.067	4000.067	4000.067	24
Bit HD	1 pc(s).	2549.510	2549.510	2549.510	2549.510	25
Enclosure key HD	1 pc(s).	2549.500	2549.500	2549.500	2549.500	24
Pressure relief stoppers, stainless steel	5 pc(s).	4000.300	4000.300	4000.300	4000.300	23

Rittal – The System.



## Fire extinguisher enclosure HD

---

See page 13

# Hygienic Design



**HD accessories** from page 23

## Design:

- Roof angled forwards by 30°

## Material:

- Enclosures and doors: Stainless steel 1.4301 (AISI 304)
- Mounting plate: Sheet steel
- Lock insert HD: Stainless steel 1.4404 (AISI 316L)
- Seal: Silicone, compliant with FDA Guideline 21 CFR 177.2600

## Surface finish:

- Enclosure and door: Brushed, grain 400, peak-to-valley height < 0.8 µm
- Mounting plate: Zinc-plated
- Seal: Blue, dyed (RAL 5010)

## Protection category IP to IEC 60 529:

- IP66
- IPX9

## Type rating to UL 50E:

- Type 1, 3, 3X, 4, 4X, 12, 13

## Supply includes:

- Enclosure of all-round solid construction
- Door with inserted seal
- Mounting plate

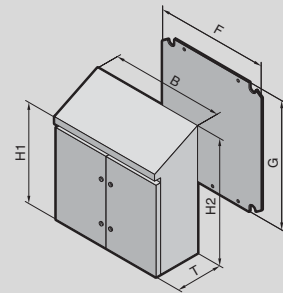

## Compact enclosure HD, two-door

Width (B) mm	Packs of	1010	1010	Page
Height front (H1) mm		1050	1250	
Height rear (H2) mm		1280	1480	
Depth (T) mm		400	400	
Mounting plate width (F) mm		945	945	
Mounting plate height (G) mm		975	1175	
Weight kg		82.0	92.5	
<b>Model No.</b>	1 pc(s).	<b>1318.600</b>	<b>1319.600</b>	
<b>Accessories</b>				
Wall spacer bracket HD	1 pc(s).	4000.100	4000.100	25
Cable gland HD		see page	see page	28
Rail for interior installation	4 pc(s).	see page	see page	29
T handle HD without lock	1 pc(s).	4000.065	4000.065	24
T handle, stainless steel with cylinder insert, lock no. 333	1 pc(s).	4000.067	4000.067	24
Bit HD	1 pc(s).	2549.510	2549.510	25
Enclosure key HD	1 pc(s).	2549.500	2549.500	24
Pressure relief stoppers, stainless steel	5 pc(s).	4000.300	4000.300	23



**HD accessories** from page 23

**Design:**

- Roof angled forwards by 30°

**Benefits:**

- Hygienic, hose-proof storage of fire extinguishers
- Time and cost savings thanks to simple, effective cleaning options
- Fire extinguisher is easily removed with one hand thanks to the T handle
- Quick inventory check with the integral viewing door

**Material:**

- Enclosure and door: Stainless steel 1.4301 (AISI 304)
- Handle and lock: Stainless steel 1.4301 (AISI 304)
- Viewing window: Polycarbonate
- Seal: Silicone, compliant with FDA Guideline 21 CFR 177.2600

**Surface finish:**

- Enclosure and door: Brushed, grain 400, peak-to-valley height < 0.8 µm
- Seal: Blue, dyed (RAL 5010)

**Protection category IP to IEC 60 529:**

- IP66

**Protection category IP to DIN 40 050-9:**

- IP59K

**Supply includes:**

- Enclosure of all-round solid construction
- Door with viewing window and inserted seal
- Interchangeable door hinge
- T handle with 3-point lock system

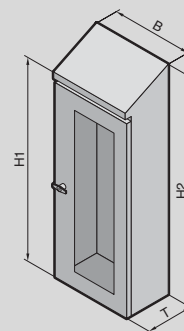

## Fire extinguisher enclosure HD

<b>Width (B) mm</b>	Packs of	390	Page
<b>Height front (H1) mm</b>		840	
<b>Height rear (H2) mm</b>		1010	
<b>Depth (T) mm</b>		300	
Viewing window width mm		190	
Viewing window height mm		670	
<b>Model No.</b>	1 pc(s).	<b>4000.075</b>	
Weight kg		22.0	
<b>Accessories</b>			
Wall spacer bracket HD	1 pc(s).	4000.100	25
Levelling feet HD		see page	25

# Hygiene-compliant control and monitoring

Command panels and printer enclosures play a key role in the decentralised control and monitoring of open processes in the food and beverages industry. Their functional design enables standard, commercially available PC systems comprising computer, monitor and, for example, a label printer to be integrated simply and securely into the production process.



### Silicone seal

- All-round external joint-free silicone seal
- Easy to replace
- Guides and fixes the lid to the screw fasteners
- All-round tilt
  - Operating housing: 30°
  - Printer enclosure 3°



### Simple monitoring

- Large viewing surface with recessed, sealed polycarbonate window in the door
- Screw-fastened mounting plate with holes for VESA 75 and 100 connection
- Attachment of monitors up to 24"



### User-friendly design

- Enclosure surface inclined by 3°
  - to ensure that liquids can drain off during cleaning
  - for use as a keyboard support during production
- Component shelf with telescopic slides for simple integration e.g. of computers or label printers
- Interior installation rails offer the option of installing additional component shelves



### Modular combination

- Connection component for combining the command panel and printer housing into one complete PC enclosure
- Integral drilled holes with 40 mm diameter for simple cable entry with connector



# Hygienic Design



Printer enclosure HD P. 17 Support arm system CP 40, stainless steel Cat. 36, p. 188 Command panel housing with door, stainless steel Cat. 36, p. 254

## Design:

- Roof angled forwards by 30°

## Benefits:

- For hygienic, secure siting of monitors and PCs in the production hall
- Combinable with HD printer enclosure to assemble a complete PC enclosure
- Holder for desktop TFT, height-adjustable for screens up to 24"

## Material:

- Enclosure and door: Stainless steel 1.4301 (AISI 304)
- Lock inserts HD: Stainless steel 1.4404 (AISI 316L)
- Viewing window: Polycarbonate
- Seal: Silicone, compliant with FDA Guideline 21 CFR 177.2600

## Surface finish:

- Enclosure and door: Brushed, grain 400, peak-to-valley height < 0.8 µm
- Seal: Blue, dyed (RAL 5010)

## Protection category IP to IEC 60 529:

- IP66

## Protection category IP to DIN 40 050-9:

- IP59K

## Supply includes:

- Enclosure of all-round solid construction
- Door with viewing window and inserted seal
- R/h door hinge
- Holder for desktop TFT with VESA 75/100 locator

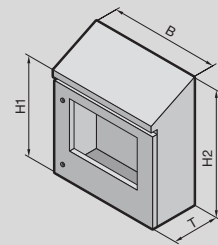

## Command panel HD

Width (B) mm	Packs of	810	Page
Height front (H1) mm		692	
Height rear (H2) mm		848	
Depth (T) mm		266	
Viewing window width mm		535	
Viewing window height mm		325	
<b>Model No.</b>	1 pc(s).	<b>4000.062</b>	
Weight kg		33.2	
<b>Accessories</b>			
Keyboard support HD	1 pc(s).	4000.072	26
Wall spacer bracket HD	1 pc(s).	4000.100	25
Cable gland HD		see page	29
Connection components HD	1 pc(s).	4000.066	25
T handle HD without lock	1 pc(s).	4000.065	24
T handle, stainless steel with cylinder insert, lock no. 333	1 pc(s).	4000.067	24
Pressure relief stoppers, stainless steel	5 pc(s).	4000.300	23





**Command panel HD** Page 16 **PC enclosure system, stainless steel** Cat. 36, page 252

**Design:**

- Enclosure angled forwards by 3°

**Benefits:**

- For hygienic, secure siting of printers in the production hall
- Combinable with HD command panel to assemble a complete PC enclosure
- Pull-out, height-adjustable component shelf for fast access to printer, e.g. for changing the labels

**Material:**

- Enclosure and door: Stainless steel 1.4301 (AISI 304)
- Lock inserts HD: Stainless steel 1.4404 (AISI 316L)
- Seal: Silicone, compliant with FDA Guideline 21 CFR 177.2600
- Component shelf: Sheet steel, spray-finished

**Surface finish:**

- Enclosure and door: Brushed, grain 400, peak-to-valley height < 0.8 µm
- Seal: Blue, dyed (RAL 5010)

**Protection category IP to IEC 60 529:**

- IP66

**Protection category IP to DIN 40 050-9:**

- IP69K

**Supply includes:**

- Enclosure of all-round solid construction
- Door with inserted seal
- Door hinged on the right, may be swapped to the left
- Component shelf

**Optional:**

- HD supporting structure with levelling

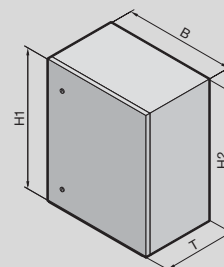

## Printer enclosure HD

Width (B) mm	Packs of	810	Page
Height front (H1) mm		863	
Height rear (H2) mm		888	
Depth (T) mm		496	
<b>Model No.</b>	1 pc(s).	<b>4000.064</b>	
Weight kg		54.2	
<b>Accessories</b>			
Cable gland HD		see page	29
Connection components HD	1 pc(s).	4000.066	25
T handle HD without lock	1 pc(s).	4000.065	24
T handle, stainless steel with cylinder insert, lock no. 333	1 pc(s).	4000.067	24
Levelling feet HD		see page	23
Pressure relief stoppers, stainless steel	5 pc(s).	4000.300	23

# HD system enclosure – System partner for the food industry

The HD system enclosure is your flexible, bayable large enclosure solution for hygienically sensitive areas which are subject to regular cleaning. The enclosure with standard VX mounting plate and lock furniture inside the sealing zone is ideally equipped with corresponding HD accessories and VX system accessories for all Hygienic Design applications.



## Seal

- Silicone profile seal between door, side panels and enclosure
- Joint-free, all-round external seal – simple to replace
- Seal dyed blue to clearly distinguish it from foodstuffs
- Silicone seal for the angled roof and baying frame



## Door

- Hinges that are inside the sealing zone create an exceptionally easy-clean design on the outside
- Locking rods for secure and sealed closing
- Easy-to-clean Hygienic Design lock insert in stainless steel – can be exchanged for a T-handle



## Designing

- Interior and base configuration with VX system accessories
- Door and enclosure frame with all-round internal VX25 system punching for installation of VX25 accessories
- Door hinged on the right, may be swapped to the left
- Mounting plate from VX25 baying system
- Integrated, non-detachable rear panel guarantees reliable hygiene and sealing in an area which is difficult to monitor
- Side panels screw-fastened from the inside
- All-round chamfered edge folds on the door and side panels make it much easier to clean
- Roof with 30° incline included in the scope of supply
- Solid base
- Reliable baying with the HD baying frame



# Hygienic Design



Interior installation Page 30 Air/water heat exchangers Page 22

## Material:

- Enclosure frame: Stainless steel 1.4301 (AISI 304), 1.5 mm
- Roof: Stainless steel 1.4301 (AISI 304), 1.5 mm, exterior brushed
- Door: Stainless steel 1.4301 (AISI 304), 2.0 mm, exterior brushed
- Mounting plate: Sheet steel, 3.0 mm
- Lock insert HD: Stainless steel 1.4404 (AISI 316L)
- Seal: Silicone, compliant with FDA Guideline 21 CFR 177.2600

## Surface finish:

- Enclosure frame and door: Brushed, grain 400, peak-to-valley height < 0,8 mm
- Mounting plate: Zinc-plated
- Seal: Blue, dyed (RAL 5010)

## Supply includes:

- Enclosure frame with welded rear panel gland plate
- Mounting plate
- Door(s) with inserted seal
- Roof attachment with 30° slope

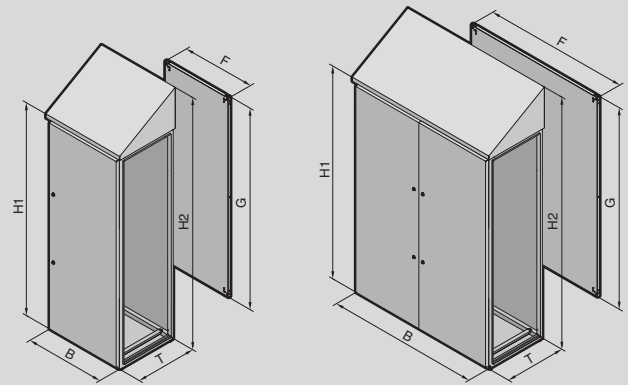

## System enclosure HD

Width mm	Packs of	600	600	800	800	1200	1200	Page
Height front (H1) mm		1842	2042	1842	2042	1842	2042	
Height rear (H2) mm		2133	2393	2133	2393	2133	2393	
Depth mm		500	600	500	600	500	600	
Mounting plate width mm		499	499	699	699	1099	1099	
Mounting plate height mm		1696	1896	1696	1896	1696	1896	
Number of doors		1	1	1	1	2	2	
Screw-fastened centre bar		–	–	–	–	■	■	
<b>Model No.</b>	1 pc(s).	<b>4000.615</b>	<b>4000.626</b>	<b>4000.815</b>	<b>4000.826</b>	<b>4000.115</b>	<b>4000.126</b>	

## Accessories

Side panels HD	2 pc(s).	4000.205	4000.206	4000.205	4000.206	4000.205	4000.206	34
Wall spacer bracket HD	1 pc(s).	4000.100	4000.100	4000.100	4000.100	4000.100	4000.100	25
Mounting plate infill	1 pc(s).	4000.518	4000.520	4000.518	4000.520	4000.518	4000.520	34
Baying frame HD	1 pc(s).	4000.718	4000.720	4000.718	4000.720	4000.718	4000.720	34
Levelling feet HD		see page	see page	see page	see page	see page	see page	23
Viewing window HD	1 pc(s).	4000.080	4000.080	4000.080	4000.080	4000.080	4000.080	24
LED system light		see page	see page	see page	see page	see page	see page	36
Punched sections with mounting flanges, 23 x 64 mm	4 pc(s).	8617.130	8617.130	8617.120	8617.130	8617.120	8617.130	31
Punched sections with mounting flanges, 18 x 64 mm	4 pc(s).	8617.030	8617.030	8617.020	8617.030	8617.020	8617.030	30
Cable gland HD		see page	see page	see page	see page	see page	see page	23
Pressure relief stoppers, stainless steel	5 pc(s).	4000.300	4000.300	4000.300	4000.300	4000.300	4000.300	23
Bit HD	1 pc(s).	2549.510	2549.510	2549.510	2549.510	2549.510	2549.510	25
Enclosure key HD	1 pc(s).	2549.600	2549.600	2549.600	2549.600	2549.600	2549.600	24
T handle HD without lock	1 pc(s).	4000.065	4000.065	4000.065	4000.065	4000.065	4000.065	24
T handle, stainless steel with cylinder insert, lock no. 333	1 pc(s).	4000.067	4000.067	4000.067	4000.067	4000.067	4000.067	24

# Air/water heat exchangers

## Hygienic Design



**An easy-to-clean enclosure climate control solution is now available for hygiene-critical production zones in the food and consumables industry.**

- Hygiene-compliant design simplifies cleaning procedures and guarantees food safety
- Protection category IP56/59 if correctly fitted – suitable for high-pressure and steam-jet cleaning
- Enclosure made from stainless steel 1.403 (AISI 304) with a 30° forward roof tilt
- Water connections made from stainless steel 1.4301 (AISI 304)
- Suitable for use in the food industry to DIN EN 1672-2:2009



# Air/water heat exchangers



**Accessories for climate control** Cat. 36, page 533 **Chillers** Cat. 36, page 519 **Therm software** Cat. 36, page 558

Air/water heat exchanger for hygienically sensitive production zones in the food and consumables industry – the optimum addition to the Rittal Hygienic Design range. The cleaning-friendly design reduces the risk of contamination and ensures food safety.

#### Benefits:

- Easy-to-clean, hygienic design
- A roof tilt of 30° prevents objects from being deposited on it, and allows liquids to run off quickly.
- All-round external, replaceable silicone seal prevents the accumulation of dirt between the enclosure and the air/water heat exchanger.

#### Material:

- Enclosures: Stainless steel 1.4301 (AISI 304)

#### Surface finish:

- Enclosure: Brushed, grain 400, peak-to-valley height < 0.8 µm

#### Protection category IP to IEC 60 529:

- IP56/59

#### Protection category NEMA:

- NEMA 4X

#### Cooling medium:

- Water (see Internet for specifications)

#### Supply includes:

- Fully wired ready for connection (plug-in terminal strip)
- Drilling template
- Sealing and assembly parts

#### Note:

- To achieve a protection category of IP66/69 to IEC 60 529, the ingress of leakage air through the condensate discharge opening must be completely prevented.

## Output class 600 – 1300 W, wall-mounted HD

Model No.		Packs of	3214.700	3215.700	Cat. 36, page
Temperature control	Thermostat-controlled magnetic valve		■	■	
<b>Total cooling output L35 W10, 200 l/h kW</b>			<b>0.6</b>	<b>1</b>	
<b>Total cooling output L35 W10, 400 l/h kW</b>			<b>0.65</b>	<b>1.2</b>	
Power consumption P <sub>el</sub> 50/60 Hz W			33 / 34	77 / 104	
Rated operating voltage V, ~, Hz			230, 1~, 50/60	230, 1~, 50/60	
Width mm			220	215	
Height mm			526	982	
Depth mm			100	100	
Rated current max. A			0.16 / 0.14	0.38 / 0.47	
Pre-fuse A			2	4	
Operating temperature range			+1 °C...+70 °C	+1 °C...+70 °C	
Setting range			+20 °C...+60 °C	+20 °C...+60 °C	
Water inlet temperature			+1 °C...+30 °C	+1 °C...+30 °C	
Water connection	G 3/8" external thread		■	■	
Permissible operating pressure (p max.) bar			1 - 10	1 - 10	
Air throughput of fans (unimpeded air flow), internal circuit 50/60 Hz m³/h			280 / 310	680 / 735	
Weight kg			6.0	14.0	
<b>Accessories</b>					
Toroidal transformer			see page	see page	550
Cooling medium (ready-mixed)			see page	see page	545

### Levelling feet HD

**Benefits:**

- Minimises cleaning time due to fully covered, permanently sealed threads
- Compensation of floor inclines up to a maximum of 10°, thanks to flexible base
- Baying can even be achieved on sloping floors, thanks to a large levelling range
- Design to EHEDG standards

**Material:**

- Stainless steel 1.4301 (AISI 304)

**Load capacity:**

- Max. 7000 N static per levelling foot

**Supply includes:**

- Assembly parts and seals

Design	Thread	Adjustment range mm	Packs of	Model No.
without base attachment	M12	122 - 175	4 pc(s).	<b>4000.240</b>
with base attachment	M12	122 - 175	4 pc(s).	<b>4000.250</b>



### Pressure relief stoppers, stainless steel

Especially when enclosures are exposed to changing climatic conditions, pressure differences may cause condensation to form in sealed enclosures. The integral sealing membrane in the pressure relief stopper largely prevents such pressure differences and hence eliminates condensation; additionally, it also prevents the ingress of moisture from the outside. Installed in vertical surfaces to protect against dirt.

**Technical specifications:**

- Length 10 mm
- Connection thread M12 x 1.5
- Air permeability up to 60 litres/hour with a pressure difference of 70 mbar

**Material:**

- Stainless steel 1.4301 (AISI 304)

**Type rating to UL 50E:**

- Type 4X
- Type 13

**IP protection category to IEC 60 529**

- IP66
- IPX8
- IPX9

**Supply includes:**

- Lock nut

Packs of	Model No.
5 pc(s).	<b>4000.300</b>

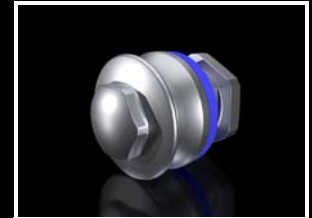

# Hygienic Design

## Accessories



### Viewing window HD

For the protection of switches or displays.

**Benefits:**

- Large viewing panel
- Gap-free transition between the viewing window and the frame
- External hinges
- With T handle for easy opening without a key

**Material:**

- Frame: Stainless steel 1.4301 (AISI 304)
- Seal: Silicone, compliant with FDA Guideline 21 CFR 177.2600
- Viewing window: Polycarbonate

**Supply includes:**

- 2 hinges
- T handle

Width mm	Height mm	Depth mm	Viewing area mm	Packs of	Model No.
518	436	23	410 x 320	1 pc(s).	<b>4000.080</b>



### T handle HD

For easy opening without a key. May be exchanged in all enclosures with cam lock.

**Material:**

- Stainless steel 1.4301 (AISI 304)

Design	Packs of	Model No.
without lock	1 pc(s).	<b>4000.065</b>



### T handle, stainless steel

As an alternative to the standard lock insert with lock cylinder insert in a hygienic design.

**Material:**

- Stainless steel 1.4301 (AISI 304)

**Supply includes:**

- With 2 keys
- Seal

Design	Packs of	Model No.
with cylinder insert, lock no. 333	1 pc(s).	<b>4000.067</b>



### Enclosure key HD

For cam lock HD.

**Note:**

- Enclosure, case and lock systems are supplied as standard with matching keys

Packs of	Model No.
1 pc(s).	<b>2549.600</b>



### Bit HD

for universal key 2549.500

Packs of	Model No.
1 pc(s).	2549.510



### Wall spacer bracket HD

#### Benefits:

- Creates space for cleaning behind the enclosure.
- Shorter assembly times by eliminating the need for an all-round seal.
- Greater hygiene safety by avoiding an inaccessible dead space or gap between the enclosure and wall.
- Mounting on the wall optionally from the enclosure interior via a through-hole (max. M8) or from the rear via an integral M10 thread.

#### Material:

- Stainless steel 1.4301 (AISI 304)

#### Supply includes:

- Assembly parts and seals

#### Note:

- Depending on the size of the enclosure, up to 4 wall spacer brackets are required to ensure sufficiently stable wall mounting

Wall distance mm	Packs of	Model No.
50	1 pc(s).	4000.100

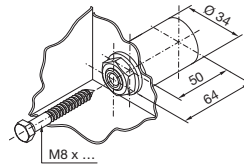

Attachment from inside

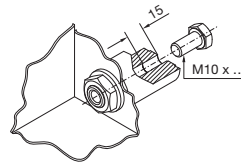

Attachment from outside



### Connection components HD

for command panel HD, printer enclosure HD

For combining the HD command panel and the HD printer enclosure into one PC enclosure.

#### Material:

- Stainless steel 1.4301 (AISI 304)

#### Supply includes:

- 2 reinforcement plates for enclosure, top
- 4 reinforcement plates for enclosure, bottom (2 for the roof, 2 for the attachment of levelling feet or supporting structure)
- 2 spacer supports with drilled hole  $\varnothing$  40 mm for cable entry, height 50/45.8 mm
- Assembly parts and seals

Packs of	Model No.
1 pc(s).	4000.066



# Hygienic Design

## Accessories



### Keyboard support HD

To support standard keyboards, including water drain hole.

**Material:**

- Stainless steel 1.4301 (AISI 304)

**Supply includes:**

- Spacer support to the enclosure

Width mm	Depth mm	Contact surface, width mm	Contact surface, depth mm	Packs of	Model No.
573	250	570	190	1 pc(s).	<b>4000.072</b>



### Silicone seal

In exchange for a damaged PU seal. This makes it more resistant to cleaning agents and disinfectants.

**Material:**

- Silicone foam profile

**Colour:**

- White

Length m	Packs of	Model No.
25	1 pc(s).	<b>5001.380</b>



**Assembly instruction:**

- The foamed-in PU seal can be removed without leaving a residue and the surface cleaned. The self-adhesive silicone seal must be pressed into the exact position, with the top horizontal sealing strip covering the vertical strip without any gaps.



### Hose-proof hood

#### to increase the protection category

For fan-and-filter units/outlet filters. Easy cleaning thanks to exterior silicone coating approved for use with foodstuffs.

#### Material:

- Stainless steel AISI 304 - 1.4301 (V2A)
- Silicone

#### Protection category IP to IEC 60 529:

- IP56 when fitted over fan-and-filter unit/outlet filter with filter mat

To fit Model No.	W x H x D mm	Protection category	Packs of	Model No.
3237....	150 x 230 x 40	NEMA 1 NEMA 12 NEMA 3 NEMA 3R	1 pc(s).	<b>3237.080</b>
3238....	176 x 245 x 55	NEMA 1 NEMA 12 NEMA 3 NEMA 4 NEMA 4X NEMA 3R	1 pc(s).	<b>3238.080</b>
3239....	233 x 330 x 55	NEMA 1 NEMA 12 NEMA 3 NEMA 4 NEMA 4X NEMA 3R	1 pc(s).	<b>3239.080</b>
3240..../3241....	282 x 390 x 85	NEMA 1 NEMA 12 NEMA 3 NEMA 4 NEMA 4X NEMA 3R	1 pc(s).	<b>3240.080</b>
3243..../3244....	350 x 480 x 110	NEMA 1 NEMA 12 NEMA 3 NEMA 4 NEMA 4X NEMA 3R	1 pc(s).	<b>3243.080</b>
3245....	350 x 480 x 160	NEMA 1 NEMA 12 NEMA 3 NEMA 3R	1 pc(s).	<b>3245.080</b>



### Connector gland, small

For pre-assembled cables with connectors.

- For use with material thickness of up to 4 mm
- Strain relief of the pre-assembled cables can be achieved with cable ties

#### Material:

- Plastic

#### Colour:

- RAL 9005

#### Protection category IP to IEC 60 529:

- IP65 if installed correctly

#### Supply includes:

- Assembly parts

To fit	Packs of	Model No.
2 cables Ø 6 – 8 mm	1 pc(s).	<b>2400.300</b>
3 cables Ø 4 – 6 mm	5 pc(s).	<b>2400.500</b>



# Hygienic Design

## Accessories

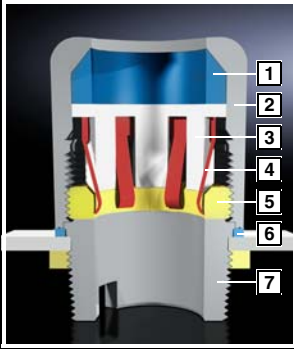

- 1 Seal
- 2 Cap nut
- 3 Gripper jaws
- 4 Shield spring (EMC version only)
- 5 Clamping ring
- 6 Enclosure seal
- 7 Base with locator for assembly tool

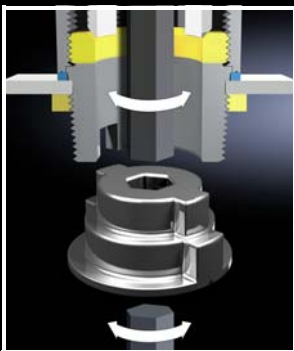

### Cable gland HD

**More compact design and the lock nut is included with the supply.**

**Applications:**

- Manufacturing and packaging of foodstuffs etc.
- Clean room technology (e.g. pharmaceuticals)
- Biotechnology
- Chemical industry

**Benefits:**

- Smooth, solid exterior surfaces effectively prevent the depositing of harmful micro-organisms
- Much easier, therefore cheaper, cleaning compared with conventional cable glands

**Material:**

- Nut: Stainless steel 1.4305 (AISI 303)
- Seal: EPDM, compliant with FDA 21 CFR 177.2600

**Protection category IP to IEC 60 529:**

- IP69
- IPX8 (5 bar, 30 min.)

**Supply includes:**

- Cable gland HD
- Lock nut

**Standard version**

Size	Cable diameter mm	Packs of	Model No.
M12 x 1.5	3 – 6.5	5 pc(s).	<b>2410.001</b>
M16 x 1.5	5 – 10	5 pc(s).	<b>2410.011</b>
M20 x 1.5	6 – 12	5 pc(s).	<b>2410.021</b>
M25 x 1.5	12 – 17	5 pc(s).	<b>2410.031</b>

**EMC version**

Size	Cable diameter mm	Packs of	Model No.
M16 x 1.5	5 – 10	5 pc(s).	<b>2410.111</b>
M20 x 1.5	6 – 12	5 pc(s).	<b>2410.121</b>
M25 x 1.5	12 – 17	5 pc(s).	<b>2410.131</b>

**Why use hygienic cable glands?**

**Critical points with conventional solutions**

- 1 Cable entry in front of seal
- 2 No minimum radii on the hexagon
- 3 External threads
- 4 Gap caused by O-ring on the enclosure surface

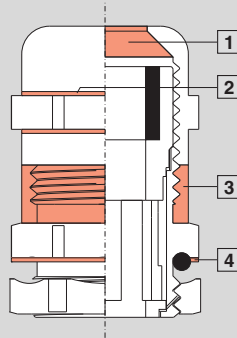

**Hygienic design features**

- 1 Seal directly at the cable entry
- 2 Compliance with minimum radii on the hexagon
- 3 No external threads
- 4 Flush termination between the cap nut and the enclosure

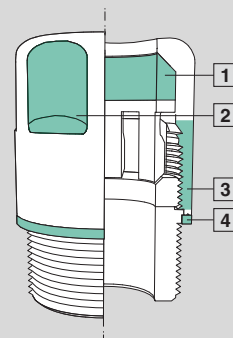

### Assembly tool

**for cable gland HD**

For attaching HD cable glands in an internal thread or using lock nuts. This can be achieved either from the inside or from the outside using an Allen key.

**Supply includes:**

- 1 pc(s). = Adaptor for sizes from M12 – M25

Packs of	Model No.
1 pc(s).	<b>2410.290</b>

# Hygienic Design

## Accessories

### Rails for interior installation

#### for HD compact enclosures

For mounting on the existing threaded bolts.  
With system punchings on three sides.

#### Material:

– Sheet steel, zinc-plated

#### Supply includes:

– Assembly parts

Length mm	Packs of	Model No.
510	4 pc(s).	<b>5001.050</b>
710	4 pc(s).	<b>5001.051</b>
910	4 pc(s).	<b>5001.052</b>
1110	4 pc(s).	<b>5001.053</b>

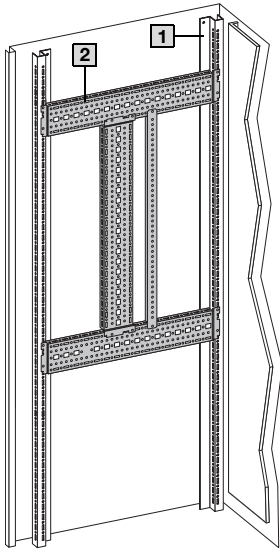

#### Interior installation, door

Enclosure	1	1	1
Model No.	Model No.		
1312.600	5001.050	–	–
1316.600 1318.600	5001.052	5001.050	5001.050
1317.600 1319.600	5001.053	5001.051 5001.050	5001.051 5001.050

#### Interior installation, enclosure

Enclosure	1	2	3
	Rails for interior installation 	TS punched section with mounting flange 17 x 73 mm 	Mounting plates 
Model No.	Model No.	Model No.	
1308.600 1310.600 1311.600 1312.600 1315.600	5001.050	–	–
1316.600	5001.052	8612.130 (only on lock side)	8612.400 8612.410
1317.600	5001.053	8612.130 (only on lock side)	8612.400 8612.410
1318.600	5001.052	8612.030 (only on lock side)	8612.400 8612.410
1319.600	5001.053	8612.030 (only on lock side)	8612.400 8612.410

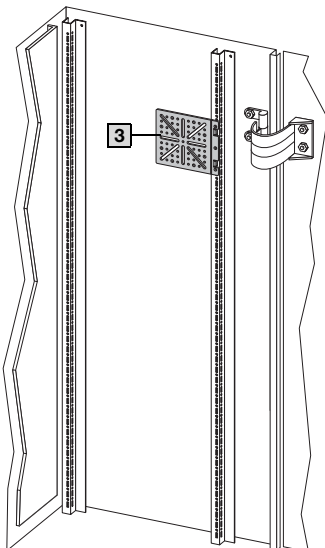

# Hygienic Design

## Accessories for HD system enclosure

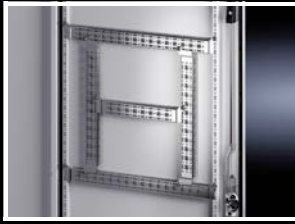

### Punched section with mounting flange, 14 x 39 mm

Secure location and fast mounting on the tubular door frame.

For attachment of

- Cable ducts
- Cable conduit holder
- Equipment installed on the door, etc.

#### Installation options:

- In the HD system enclosure, on the tubular door frame

#### Material:

- Sheet steel

#### Surface finish:

- Zinc-plated

#### Supply includes:

- Assembly parts

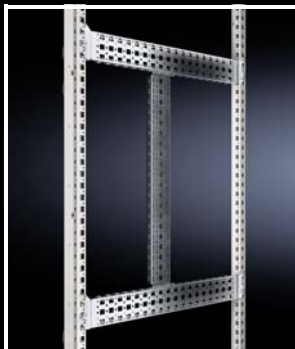
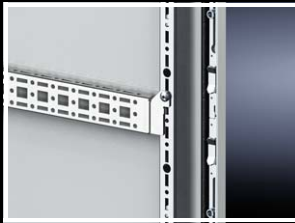

For door width mm	Distance between attachment points mm	Packs of	Model No.
500	375	4 pc(s).	<b>8619.710</b>
600	475	4 pc(s).	<b>8619.720</b>
800	675	4 pc(s).	<b>8619.730</b>

#### + Accessories:

- Screws and self-tapping screws M5 for configuring the customer's own components on the punched section with mounting flange, see Cat. 36, page 1004

### Punched section with mounting flange, 18 x 64 mm

For variable, individual interior installation of the enclosure frame on the outer mounting level. Simply locate into the system punchings from the outside and screw-fasten. System punchings on all four sides. With pre-bayed enclosures, the punched sections with mounting flanges may also be fitted from the inside of the enclosure.

#### Installation options:

- System enclosure HD
- On the outer mounting level, on the enclosure section

#### System accessories

- On the outer mounting level, between two punched sections with mounting flanges 23 x 64 mm

#### Material:

- Sheet steel

#### Surface finish:

- Zinc-plated

#### Supply includes:

- Assembly parts

For enclosure width/height/depth mm	Packs of	Model No.
300	4 pc(s).	<b>8617.000</b>
400	4 pc(s).	<b>8617.010</b>
500	4 pc(s).	<b>8617.020</b>
600	4 pc(s).	<b>8617.030</b>
800	4 pc(s).	<b>8617.040</b>
1000	4 pc(s).	<b>8617.050</b>
1200	4 pc(s).	<b>8617.060</b>

#### + Accessories:

- Screws, see Cat. 36, page 1004
- Cable ties 2597.000, see Cat. 36, page 1061

# Hygienic Design

## Accessories for HD system enclosure

### Punched section with mounting flange, 23 x 64 mm

For variable, individual interior installation. Simply locate into punchings and screw-fasten. System punchings on all four sides. With slots at the top and bottom for cage nuts, for attaching your own components via metric screws.

#### Installation options:

System enclosure HD  
 – On the inner mounting level, on the enclosure section

System accessories

– On identical punched sections with mounting flanges

#### Material:

– Sheet steel

#### Surface finish:

– Zinc-plated

#### Supply includes:

– Assembly parts

For enclosure width/height/depth mm	Packs of	Model No.
300	4 pc(s).	<b>8617.100</b>
400	4 pc(s).	<b>8617.110</b>
500	4 pc(s).	<b>8617.120</b>
600	4 pc(s).	<b>8617.130</b>
800	4 pc(s).	<b>8617.140</b>
1000	4 pc(s).	<b>8617.150</b>
1200	4 pc(s).	<b>8617.160</b>
1400	4 pc(s).	<b>8617.170</b>
1600	4 pc(s).	<b>8617.180</b>
1800	4 pc(s).	<b>8617.190</b>
2000	4 pc(s).	<b>8617.200</b>



#### Accessories:

- Screws, see Cat. 36, page 1004
- Cable ties 2597.000, see Cat. 36, page 1061
- Cage nuts, see page 33

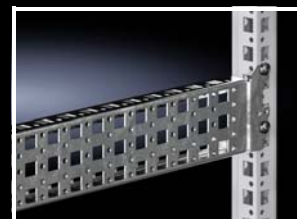

### Punched section without mounting flange, 23 x 64 mm

For variable, individual interior installation of the enclosure frame on the inner mounting level. When mounted, the punched sections and rails sit flush to the enclosure frame. Thanks to the additional mounting bracket, they can be used with a pre-installed mounting plate and can also be cut to any required length. System punchings on all four sides. With slots at the top and bottom for cage nuts, for attaching your own components via metric screws.

#### Installation options:

System enclosure HD  
 – On the inner mounting level, on the enclosure section

System accessories

– Between two punched sections on the inner mounting level

#### Material:

– Sheet steel

#### Surface finish:

– Zinc-plated

#### Supply includes:

- 1 pack =  
 2 punched sections without mounting flanges,  
 23 x 64 mm  
 4 mounting brackets

For enclosure width/height/depth mm	Packs of	Model No.
400	2 pc(s).	<b>8100.740</b>
500	2 pc(s).	<b>8100.741</b>
600	2 pc(s).	<b>8100.742</b>
800	2 pc(s).	<b>8100.743</b>
1200	2 pc(s).	<b>8100.745</b>

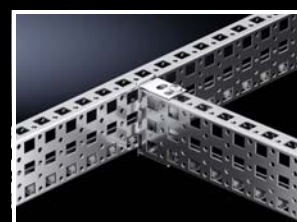
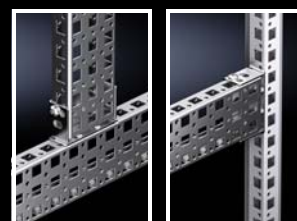

# Hygienic Design

## Accessories for HD system enclosure



### Punched rail 18 x 39 mm

For variable, individual interior installation of the enclosure frame on the inner mounting level, may also be used in conjunction with other punched sections. Prepared at the rear to accommodate cable clamps for optimum cable routing inside the enclosure.

#### Installation options:

- System enclosure HD
- On the inner mounting level, on the enclosure section

#### Material:

- Sheet steel

#### Surface finish:

- Zinc-plated

#### Supply includes:

- Assembly parts

For enclosure width/depth mm	Packs of	Model No.
500	4 pc(s).	<b>8617.710</b>
600	4 pc(s).	<b>8617.720</b>
800	4 pc(s).	<b>8617.730</b>

#### Note:

- In enclosures with a mounting plate, two punched rails (as mounting plate slide rails) are already included with the supply

#### Accessories:

- Screws, see Cat. 36, page 1004
- Cable ties 2597.000, see Cat. 36, page 1061
- Cable clamps, see Cat. 36, page 1060

### Support strip

For simple cable routing from the mounting plate to the door.

#### Installation options:

- On the inner mounting level, on the enclosure section

#### Material:

- Sheet steel

#### Surface finish:

- Zinc-plated

#### Supply includes:

- Assembly parts

#### Accessories:

- Screws, see Cat. 36, page 1004
- Cable ties 2597.000, see Cat. 36, see page 1061

For enclosure width/depth mm	Rail mounting distance mm	Packs of	Model No.
500	425	20 pc(s).	<b>4695.000</b>
600	525	20 pc(s).	<b>4696.000</b>
800	725	20 pc(s).	<b>4697.000</b>



# Hygienic Design

## Accessories for HD system enclosure

### Cage nut

For all-round metric mounting on the enclosure section.

#### Benefits:

- For all-round mounting on the enclosure section
- The compression spring, designed as an insertion aid, ensures reliable mechanical and electrical connection in the system punchings.
- Simply slides in from the side
- Safely and easily released with a screwdriver

#### Installation options:

- On the vertical and horizontal HD enclosure section
- On punched sections with mounting flanges, 23 x 64 mm
- On punched section without mounting flange, 23 x 64 mm
- On enclosures and rails with rectangular system punching 12.5 x 11 mm

Thread	Packs of	Model No.
M5	20 pc(s).	<b>4166.500</b>
M6	20 pc(s).	<b>4164.500</b>
M8	20 pc(s).	<b>4165.500</b>



### Cable clamp rail

For strain relief with cable entry. Depth-variable mounting on a 25 mm pitch pattern on the horizontal enclosure section.

#### Material:

- Steel

#### Surface finish:

- Zinc-plated

#### Supply includes:

- Assembly parts

Enclosure width mm	Packs of	Model No.
600	2 pc(s).	<b>8619.410</b>
800	2 pc(s).	<b>8619.420</b>
1200	2 pc(s).	<b>8619.440</b>



#### Accessories:

- Base/plinth installation bracket, see Cat. 36, page 885

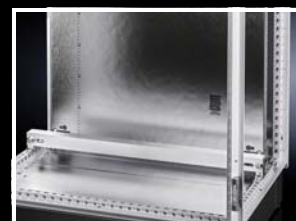

### Cable clamp

#### for cable clamp rails

For fastening the cables to the cable clamp rails.

#### Material:

- Sheet steel

#### Surface finish:

- Zinc-plated

#### Supply includes:

- Plastic insert

For cable diameter mm	Packs of	Model No.
6 - 12	25 pc(s).	<b>2350.000</b>
12 - 16	25 pc(s).	<b>2351.000</b>
14 - 18	25 pc(s).	<b>2352.000</b>
18 - 22	25 pc(s).	<b>2353.000</b>
22 - 26	25 pc(s).	<b>2354.000</b>
26 - 30	25 pc(s).	<b>2355.000</b>
30 - 34	25 pc(s).	<b>2356.000</b>
34 - 38	25 pc(s).	<b>2357.000</b>
38 - 42	25 pc(s).	<b>2358.000</b>
42 - 46	25 pc(s).	<b>2359.000</b>
46 - 50	25 pc(s).	<b>2360.000</b>



#### Possible alternative:

- Rail for EMC shielding bracket and strain relief, see Cat. 36, page 1029



# Hygienic Design

## Accessories for HD system enclosure



### Side panels HD for HD system enclosure

**Material:**

- Stainless steel 1.4301 (AISI 304), 2.0 mm

**Surface finish:**

- Brushed, grain size 400, peak-to-valley height < 0.8 µm

**Supply includes:**

- With assembly parts for screw-fastening from the inside

**Note:**

- The overall enclosure width is increased by 25 mm for each side panel fitted

For enclosure height mm	For enclosure depth mm	Packs of	Model No.
1800	500	2 pc(s).	<b>4000.205</b>
2000	600	2 pc(s).	<b>4000.206</b>



### Baying frame HD for HD system enclosure

**Material:**

- Stainless steel 1.4301 (AISI 304)

**Supply includes:**

- Seal
- Assembly parts

**Note:**

- The overall width of the bayed suite is increased by 44 mm for each baying frame used

For enclosure height mm	For enclosure depth mm	Packs of	Model No.
1800	500	1 pc(s).	<b>4000.718</b>
2000	600	1 pc(s).	<b>4000.720</b>



### Mounting plate infill HD for HD system enclosure

For a continuous mounting surface in bayed suites where the mounting plate is set forward.

**Material:**

- Sheet steel, 2 mm

**Surface finish:**

- Zinc-plated

**Supply includes:**

- Assembly parts

For enclosure height mm	Packs of	Model No.
1800	1 pc(s).	<b>4000.518</b>
2000	1 pc(s).	<b>4000.520</b>



# Hygienic Design

## Accessories for HD system enclosure

### Wiring plan pocket, sheet steel for HD system enclosure

For fastening to tubular door frames at any height.

**Colour:**

- RAL 7035

**Supply includes:**

- Assembly parts

**D = 90 mm**

To fit door width mm	Clearance opening mm		Model No.
	W	H	
600	455	210	<b>4116.000</b>
800	655	210	<b>4118.000</b>

**D = 35 mm**

To fit door width mm	Clearance opening mm		Model No.
	W	H	
600	455	210	<b>4116.500</b>
800	655	210	<b>4118.500</b>

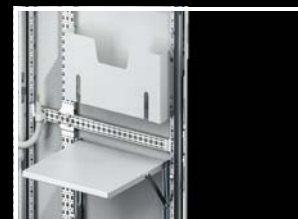

# LED system light



## Benefits:

- Optimum illumination of the entire enclosure
- Optionally with clip, screw or magnetic attachment
- Equipment to suit every application

## Material:

- Plastic
- Aluminium

## Colour:

- Enclosure: RAL 7016

## Light colour:

- 4000 K (neutral white)

## Supply includes:

- Assembly screws

## Note:

- Connection accessories should be ordered separately

Model No.		2500.300	2500.310	2500.311	2500.312	2500.313	Page
Output (lumens)		1200	1200	1200	1200	1200	
Length (mm)		437	437	437	437	437	
Motion sensor		■	■	■	■	■	
Rated operating voltage	100 – 240 V AC	■	■	■	■	■	
	24 V DC	–	–	–	–	–	
Protection class	II (all-insulated)	■	■	■	■	■	
	III (safety extra-low voltage)	–	–	–	–	–	
Equipment	Socket	–	D, earthing-pin	GB	F/B	CH	
	90° rotating connector	■	■	■	■	■	
	Adjustable light direction	■	■	■	■	■	
	Adjustable light distribution	■	■	■	■	■	
Approvals	UL/cUL	■	–	–	–	–	
	CSA	■	–	–	–	–	
	CCC	■	–	–	–	–	
	ENEC	■	■	■	■	■	
Installation type	Screw-fastening	■	■	■	■	■	
	Clip attachment	■	■	■	■	■	
	Magnetic attachment to surfaces (accessory)	■	–	–	–	–	
Connection options	Infeed	3-pole	3-pole	3-pole	3-pole	3-pole	
	Through-wiring	3-pole	3-pole	3-pole	3-pole	3-pole	
	Door-operated switch (accessory)	–	–	–	–	–	
Mounting options	Enclosures with a 25 mm pitch pattern	Directly on the profile	Directly on the profile	Directly on the profile	Directly on the profile	Directly on the profile	
	Screw fastening/clip	Directly on the profile	Directly on the profile	Directly on the profile	Directly on the profile	Directly on the profile	

## Accessories

Mounting kit magnet	2500.490	–	–	–	–	–	Cat. 36, p. 1024
Door-operated switch	–	–	–	–	–	–	
Door-operated switch, UL	–	–	–	–	–	–	

## Connection accessories

Infeed, 2-pole	–	–	–	–	–	–	
Infeed, 2-pole, UL	–	–	–	–	–	–	
Infeed, 3-pole	2500.400	2500.400	2500.400	2500.400	2500.400	2500.400	41
Infeed, 3-pole, UL	2500.500	–	–	–	–	–	41
Through-wiring, 2-pole	–	–	–	–	–	–	
Through-wiring, 2-pole, UL	–	–	–	–	–	–	
Through-wiring, 3-pole	2500.430	2500.430	2500.430	2500.430	2500.430	2500.430	41
Through-wiring, 3-pole, UL	2500.530	–	–	–	–	–	41

# LED system light

<b>Model No.</b>		<b>2500.314</b>	<b>2500.320</b>	<b>2500.200</b>	<b>2500.210</b>	<b>2500.211</b>	Page
Output (lumens)		1200	1200	900	900	900	
Length (mm)		437	437	437	437	437	
Motion sensor		■	■	–	–	–	
Rated operating voltage	100 – 240 V AC	100 – 125 V AC	–	■	■	■	
	24 V DC	–	■	–	–	–	
Protection class	II (all-insulated)	■	–	■	■	■	
	III (safety extra-low voltage)	–	■	–	–	–	
Equipment	Socket	USA / CDN	–	–	D, earthing-pin	GB	
	90° rotating connector	■	■	■	■	■	
	Adjustable light direction	■	■	–	–	–	
	Adjustable light distribution	■	■	■	■	■	
Approvals	UL/cUL	■	■	■	–	–	
	CSA	■	–	■	–	–	
	CCC	–	■	■	–	–	
	ENEC	■	–	■	■	■	
Installation type	Screw-fastening	■	■	■	■	■	
	Clip attachment	■	■	■	■	■	
	Magnetic attachment to surfaces (accessory)	–	■	■	–	–	
Connection options	Infeed	3-pole	2-pole	3-pole	3-pole	3-pole	
	Through-wiring	3-pole	2-pole	3-pole	3-pole	3-pole	
	Door-operated switch (accessory)	–	–	■	■	■	
Mounting options	Enclosures with a 25 mm pitch pattern	Screw fastening/clip	Directly on the profile	Directly on the profile	Directly on the profile	Directly on the profile	Directly on the profile

## Accessories



Mounting kit magnet	–	2500.490	2500.490	–	–	Cat. 36, p. 1024
Door-operated switch	–	–	2500.460	2500.460	2500.460	41
Door-operated switch, UL	–	–	2500.470	–	–	41

## Connection accessories

Infeed, 2-pole	–	–	–	–	–	
Infeed, 2-pole, UL	–	2500.410	–	–	–	41
Infeed, 3-pole	–	–	2500.400	2500.400	2500.400	41
Infeed, 3-pole, UL	2500.500	–	2500.500	–	–	41
Through-wiring, 2-pole	–	–	–	–	–	
Through-wiring, 2-pole, UL	–	2500.440	–	–	–	41
Through-wiring, 3-pole	–	–	2500.430	2500.430	2500.430	41
Through-wiring, 3-pole, UL	2500.530	–	2500.530	–	–	41

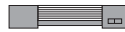

# LED system light

					
Model No.	2500.212	2500.213	2500.214	2500.220	Page
Output (lumens)	900	900	900	900	
Length (mm)	437	437	437	437	
Motion sensor	-	-	-	-	
Rated operating voltage	100 – 240 V AC	■	■	100 – 125 V AC	
	24 V DC	-	-	-	■
Protection class	II (all-insulated)	■	■	■	
	III (safety extra-low voltage)	-	-	-	■
Equipment	Socket	F/B	CH	USA / CDN	
	90° rotating connector	■	■	■	■
	Adjustable light direction	-	-	-	-
	Adjustable light distribution	■	■	■	■
Approvals	UL/cUL	-	-	■	■
	CSA	-	-	■	■
	CCC	-	-	-	■
	ENEC	■	■	■	■
Installation type	Screw-fastening	■	■	■	■
	Clip attachment	■	■	■	■
	Magnetic attachment to surfaces (accessory)	-	-	-	■
Connection options	Infeed	3-pole	3-pole	3-pole	2-pole
	Through-wiring	3-pole	3-pole	3-pole	2-pole
	Door-operated switch (accessory)	■	■	■	■
Mounting options	Enclosures with a 25 mm pitch pattern	Directly on the profile	Directly on the profile	Directly on the profile	Directly on the profile
	Screw fastening/clip				

## Accessories

Mounting kit magnet	-	-	-	2500.490	Cat. 36, p. 1024
Door-operated switch	2500.460	2500.460	2500.460	2500.460	41
Door-operated switch, UL	-	-	2500.470	2500.470	41

## Connection accessories

Infeed, 2-pole	-	-	-	-	
Infeed, 2-pole, UL	-	-	-	2500.410	41
Infeed, 3-pole	2500.400	2500.400	-	-	41
Infeed, 3-pole, UL	-	-	2500.500	-	41
Through-wiring, 2-pole	-	-	-	-	
Through-wiring, 2-pole, UL	-	-	-	2500.440	41
Through-wiring, 3-pole	2500.430	2500.430	-	-	41
Through-wiring, 3-pole, UL	-	-	2500.530	-	41

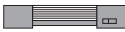
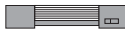
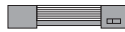
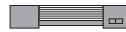

# LED system light

						
Model No.	2500.100	2500.104	2500.110	2500.114	Page	
Output (lumens)	400	400	600	600		
Length (mm)	262	262	337	337		
Motion sensor	-	-	-	-		
Rated operating voltage	100 – 240 V AC	■	■	■		
	24 V DC	-	-	-		
Protection class	II (all-insulated)	■	■	■		
	III (safety extra-low voltage)	-	-	-		
Equipment	Socket	-	-	-		
	90° rotating connector	-	-	-		
	Adjustable light direction	-	-	-		
	Adjustable light distribution	-	-	-		
Approvals	UL/cUL	-	■	-	■	
	CSA	-	■	-	■	
	CCC	■	■	■	■	
	ENEC	■	■	■	■	
Installation type	Screw-fastening	■	■	■	■	
	Clip attachment	■	■	■	■	
	Magnetic attachment to surfaces (accessory)	■	■	■	■	
Connection options	Infeed	2-pole	2-pole	2-pole	2-pole	
	Through-wiring	2-pole	2-pole	2-pole	2-pole	
	Door-operated switch (accessory)	■	■	■	■	
Mounting options	Enclosures with a 25 mm pitch pattern	Screw fastening/clip	Directly on the profile	Directly on the profile	Directly on the profile	Directly on the profile

## Accessories

Mounting kit magnet	2500.490	2500.490	2500.490	2500.490	Cat. 36, p. 1024
Door-operated switch	2500.460	-	2500.460	-	41
Door-operated switch, UL	-	2500.470	-	2500.470	41

## Connection accessories

Infeed, 2-pole	2500.420	-	2500.420	-	41
Infeed, 2-pole, UL	-	2500.520	-	2500.520	41
Infeed, 3-pole	-	-	-	-	
Infeed, 3-pole, UL	-	-	-	-	
Through-wiring, 2-pole	2500.450	-	2500.450	-	41
Through-wiring, 2-pole, UL	-	2500.550	-	2500.550	41
Through-wiring, 3-pole	-	-	-	-	
Through-wiring, 3-pole, UL	-	-	-	-	

# LED system light

## Accessories



### Socket box

#### for LED system light

In combination with the LED system light, the socket box creates a flexible modular system for international use.

#### Benefits:

- Identical connection accessories as for LED system light
- Cascadable with LED system light
- Supports flexible installation throughout the entire enclosure and on the tubular door frame
- No additional wiring required, thanks to simple connection technology and integration of the LED system light into the circuit

#### Material:

- Plastic

#### Colour:

- RAL 7016

#### Protection class:

- II (all-insulated)







#### Supply includes:

- Assembly parts

#### Configuration examples:

See Cat. 36, from page 1020

- 1 Infeed
- 2 Socket box
- 3 Through-wiring
- 4 LED system light
- 5 T distributor

Socket	UL	Packs of	Model No.
	D, earthing-pin	–	1 pc(s). <b>2500.710</b>
	GB	–	1 pc(s). <b>2500.711</b>
	F/B	–	1 pc(s). <b>2500.712</b>
	CH	–	1 pc(s). <b>2500.713</b>
	US	■	1 pc(s). <b>2500.714</b>
	CN	–	1 pc(s). <b>2500.715</b>



#### Also required:

- Depending on the application, through-wiring or a 3-pole infeed may be required, see page 41



#### Accessories:

- T distributor, see page 41
- Through-wiring, 3-pole, see page 41
- Infeed, 3-pole, see page 41

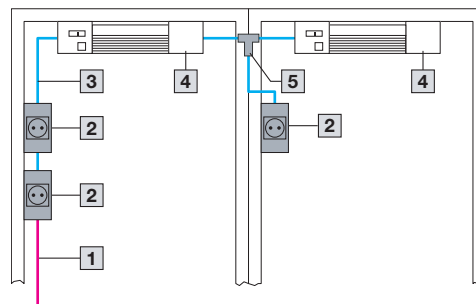



# LED system light

## Accessories

### Connection accessories

#### for LED system light

The following components can be used for time-saving, easy installation of the lights:

#### + Accessories:

- Cable ties for quick assembly, see Cat. 36, page 1061

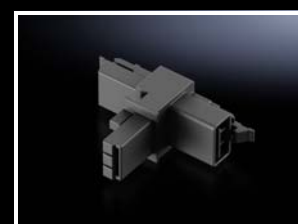
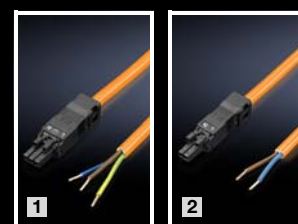

Connection cable for	ENEC	UL	Length mm	Packs of	Model No.	
					orange	black
[1] Infeed, 3-pole, 100 – 240 V AC	■	■	3000	1	2500.500	-
	■	-	3000	5	2500.400	-
[2] Infeed, 2-pole, 100 – 240 V AC	-	■	3000	1	2500.520	-
	■	-	3000	5	2500.420	-
[3] Infeed, 2-pole, 24 V DC	■	■	3000	5	-	2500.410
[4] Through-wiring, 3-pole, 100 – 240 V AC	■	-	200	1	2500.435	-
	■	■	1000	1	2500.530	-
[5] Through-wiring, 2-pole, 100 – 240 V AC	-	■	3000	1	2500.550	-
	■	-	1000	5	2500.450	-
[6] Through-wiring, 2-pole, 24 V DC	■	■	1000	5	-	2500.440

- [A] Connection cable for infeed
- [B] Connection cable for through-wiring
- [C] Door-operated switch with connection cable (not required for LED system light with integral motion sensor)

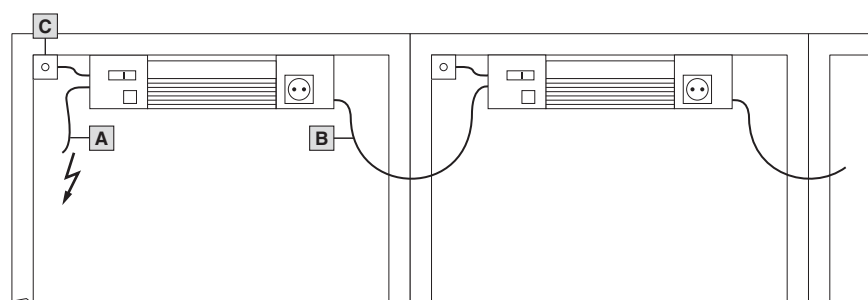

### T distributor

#### with two sockets and one connector

For creating safe, shock-hazard-protected junctions when wiring LED system lights and socket boxes.

Packs of	Model No.
5 pc(s).	2500.680

### Door-operated switch

#### with connection cable for LED system light

#### Protection category:

- IP40

#### Supply includes:

- Assembly parts

Connection cable	ENEC	UL	Length mm	To fit	Packs of	Model No.
						black
	■	-	800	230 V AC/24 V DC, 1 A	1 pc(s).	2500.460
	-	■	800		1 pc(s).	2500.470

# Hygienic Design enclosures at the Landgeflügel chicken processing



The special protection offered by HD enclosures is also invaluable in peripheral areas.



The state-of-the-art poultry plants Emsland Frischgeflügel in Haren and Celler Land Frischgeflügel in Wietze, Lower Saxony, produce poultry portions – from chicken wings, to legs, to fillets – for the food retail sector and for industrial processing.

Each day, more than 500,000 packets of fresh poultry leave the two slaughterhouses and butchery plants belonging to North-German company Landgeflügel. Sophisticated technology, the highest possible hygiene standards and a continuous cooling chain are vital for safe poultry production. Special Hygienic Design enclosures HD provide additional process and operational reliability, by protecting the sensitive control electronics in the automated production plants.

They are installed at the rear of the production plant, where all system parts are thoroughly cleaned and disinfected each night. Despite being exposed to large quantities of water, the HD enclosures remain completely water-tight during the daily washdown.

The blue silicone seal, which is resistant to all types of disinfectant, guarantees a permanent tight seal. Located externally, it provides a gap-free, secure seal for the door and enclosure.

## A

Accessories	23 – 41
Air/water heat exchangers	22
Assembly tool	
– for cable gland HD	28

## B

Baying frame HD	
– for HD system enclosure	34
Bit HD	25

## C

Cable clamp	
– for cable clamp rails	33
Cable clamp rail	
– Right angle section	33
Cable gland HD	28
Cage nut	33
Clamp rail for cables	33
Command panel HD	16
Compact enclosure HD	
– single-door	10, 11
– two-door	12
Connection accessories	
– for LED system light	41
Connection components HD	
– for command panel HD, printer enclosure HD	25
Connector gland	27

## D

Door-operated switch	
– for LED system light	41

## E

Enclosure key HD	24
------------------	----

## F

Fire extinguisher enclosure HD	13
--------------------------------	----

## H

Heat exchangers HD	
– Air/water	22
Hose-proof hood	
– for fan-and-filter units/outlet filters	27

## K

Keyboard support HD	26
---------------------	----

## L

LED system light	36 – 41
Levelling feet	23

## M

Mounting plate infill HD	
– for system enclosure HD	34

## N

NEMA 4X	
– Compact enclosures HD, two-door	12
Nut	33

## P

Pressure relief stoppers, stainless steel	23
Printer enclosure HD	17
Punched rail 18 x 39 mm	32
Punched section with mounting flange	
– 14 x 39 mm	30
– 18 x 64 mm	30
– 23 x 64 mm	31
Punched section without mounting flange, 23 x 64 mm	31

## R

Rails for interior installation HD	29
------------------------------------	----

## S

Sheet steel wiring plan pocket	35
Side panels HD	34
Silicone seal	26
Socket box	
– for LED system light	40
Support strip	32
Switch housings	8
System enclosure HD	20
– Baying frame HD	34
– Mounting plate infill HD	34

## T

T distributor	
– for LED system light	41
T handle	
– HD	24
– Stainless steel	24
Terminal boxes HD	9

## V

Viewing window HD	24
-------------------	----

## W

Wall spacer bracket HD	25
------------------------	----

# Rittal – The System.

Faster – better – everywhere.

- Enclosures
- Power Distribution
- Climate Control
- IT Infrastructure
- Software & Services

You can find the contact details of all Rittal companies throughout the world here.



[www.rittal.com/contact](http://www.rittal.com/contact)

XWWW00029EN2301

ENCLOSURES

POWER DISTRIBUTION

CLIMATE CONTROL

IT INFRASTRUCTURE

SOFTWARE & SERVICES



FRIEDHELM LOH GROUP