

Rittal – The System.

Faster – better – everywhere.

Stripping machine S22



AS 4050.451

Operating instructions

ENCLOSURES

POWER DISTRIBUTION

CLIMATE CONTROL

IT INFRASTRUCTURE

SOFTWARE & SERVICES

FRIEDHELM LOH GROUP



Contents

1	About this documentation.....	3
2	General safety instructions.....	4
2.1	Intended use	4
2.2	The following is not permitted.....	4
2.3	Machine dangers.....	4
2.4	Operational hazards.....	4
2.5	Hazard sources.....	4
2.6	Safety equipment.....	5
2.7	Warning signs at and on the machine or components	5
2.8	Residual risks.....	5
2.9	Safety measures at the installation site.....	5
2.10	Notes for the operating company.....	5
2.11	Noise	6
3	Device description	7
3.1	Overview	7
3.2	Technical data	7
4	Operating instructions.....	8
4.1	Setting up the machine	8
4.2	Switch on the machine.....	8
4.3	Setting the length unit (mm or inch).....	8
4.4	Setting the cross-section.....	9
4.5	Setting the stripping length.....	10
4.6	Setting the draw-off length.....	11
4.7	Wire entry	11
4.8	Menu	12
4.8.1	"Display" menu: Automatic work menu	12
4.8.2	"Manual" menu (manual control for removing the stripped insulation scrap).....	12
4.8.3	"Counter" menu.....	13
5	Maintenance	13
5.1	Emptying the stripped insulation scrap container	13
5.2	Interior	13
5.3	Replacing the insulation stripping blade.....	14
6	Troubleshooting	14
6.1	Machine does not start	14
6.2	No start for inserted wire.....	15
6.3	Larger number of rejects.....	15
6.4	Error messages.....	15
7	Electrical connection diagram	16
8	Spare parts	16
9	Disposal	17

1 About this documentation

The warnings in this documentation are structured differently depending on the severity of danger.



Warning!
Possible risk of fatality!
Notices with the signal word "warning" warn you about situations which could lead to fatal or serious injuries if you do not pay attention to the notices specified.









Caution!
Risk of injury!
Notices with the signal word "caution" warn you about situations which could lead to injury if you do not pay attention to the notices specified.

Attention!

Property damage!

Notices with the signal word "attention" warn you about dangers which could result in damage to property.

Situation-related warnings may contain the following warning symbols:

Symbol	Meaning
	Warning: dangerous electrical voltage
	Warning: injury to hands due to sharp blades
	Work may only be performed by a qualified electrician
	Only perform work with personal protective equipment
	Disconnect the mains plug
	Notes on documentation

Additional formatting is used in the rest of the text which has the following meaning:



Note:
This constitutes information which is not related to safety, but which provides important information regarding correct and effective work.

- This symbol indicates an "action point" and shows that you should perform an operation or procedure.

- Bullet points are indicated with dashes.

Operating instructions in other languages can be found on our website:



Click here!

2 General safety instructions

2.1 Intended use

The machine is an insulation stripping machine designed exclusively for stripping insulation from flexible conductors. For this reason, because of its construction, the machine has only this intended use.

For the intended use, the following must be observed:

- All notes from the operating instructions
- The documentation of the supplied products, as well as
- The notes for servicing/maintenance

Any other use is deemed improper.

The details in section 3.2 "Technical data" as well as in the original documentation for any accompanying supplied products must be observed and adhered to. An improper use of the product is not known to the manufacturer. The manufacturer is not liable for any damage resulting from inappropriate or unintended use.

2.2 The following is not permitted

- Removing notification or warning signs.
- Opening the machine during operation.
- Using the machine with obvious defects or damage.
- The insertion of objects that are not conductors.

2.3 Machine dangers

A risk evaluation with final safety inspection was performed on the insulation stripping machine.

2.4 Operational hazards

The operator may rectify only those faults for which the housing does not need to be removed.

- The machine must be disconnected from the power grid before changing tools or spare parts.

2.5 Hazard sources

- Before performing servicing, maintenance and cleaning work on the machine, switch off the machine, disconnect it from the power supply (e.g. cut off the electricity supply, switch off the fuse).



Caution!

Risk of injury due to missing safety equipment!

- Never remove safety equipment or decommission it by making changes to the machine.

2.6 Safety equipment

Safety equipment is installed to protect personnel. The operating company is obliged to inspect the safety devices annually.

- Housing: After removal of the housing, ensure that the earthing wire is inserted before the machine is closed again. The housing may be removed only by specialists or qualified personnel.
- Switched-mode power supply: The SMPS protects against dangerous voltages, because not more than 60 VAC or 110 VDC may be present.

Under no circumstances may safety devices be changed, removed or circumvented by changes to the machine.

2.7 Warning signs at and on the machine or components

- PE conductor connection: This marking is placed on the earth screw.

Symbol	Meaning
	The protective earth is a measure that in the event of a fault protects against dangerous touch voltage and electrical shock. The "protective earth" measure is provided by the protective conductor.

The connection is made via an IEC connector with leading protective conductor contact. The "PE" protective conductor (green/yellow insulating sheath only in Germany) is used for these protective measures.

2.8 Residual risks

Even when all safety and warning notes are observed, residual risks remain for the machine operation.

The machine is state-of-the-art and built according to recognised safety regulations. Nevertheless, hazards for users or third-parties can result when operating the machine.

- The machine may be used only for the intended purpose.
- The machine must be in proper safety condition during commissioning.



Warning!

Electrical shock caused by working on live components!

- Only authorised personnel may perform work on electronic components.

2.9 Safety measures at the installation site

The machine must be placed stable on a table.

- There is a large hazard risk should a machine fall.



Note:

Inner-company instructions and checks should ensure that the workplace and its vicinity remain clean and uncluttered.

2.10 Notes for the operating company

- The operating company is obliged to write operating instructions.
- The operating company is obliged to inspect the safety devices annually.
- Deploy only original fuses with the specified amperage.
- Knowledge of the local, operational safety and accident-prevention regulations.
- All notes on machines must be kept legible, and renewed when necessary.
- Notify the manufacturer without delay should defects become apparent, provided they were not caused intentionally.

2 General safety instructions

EN



Incorrect operation can lead to defects and malfunctioning. We strongly recommend that you take up the offer of an RAS Service training seminar for the operators of your semi-automated machines. To arrange training, please contact your Rittal service partner.

2.11 Noise

The A-evaluated equivalent continuous sound pressure level of the insulation stripping machine is ≤ 70 dB(A).

Consequently, ear muffs are not required for operating the machine.

3 Device description

3.1 Overview

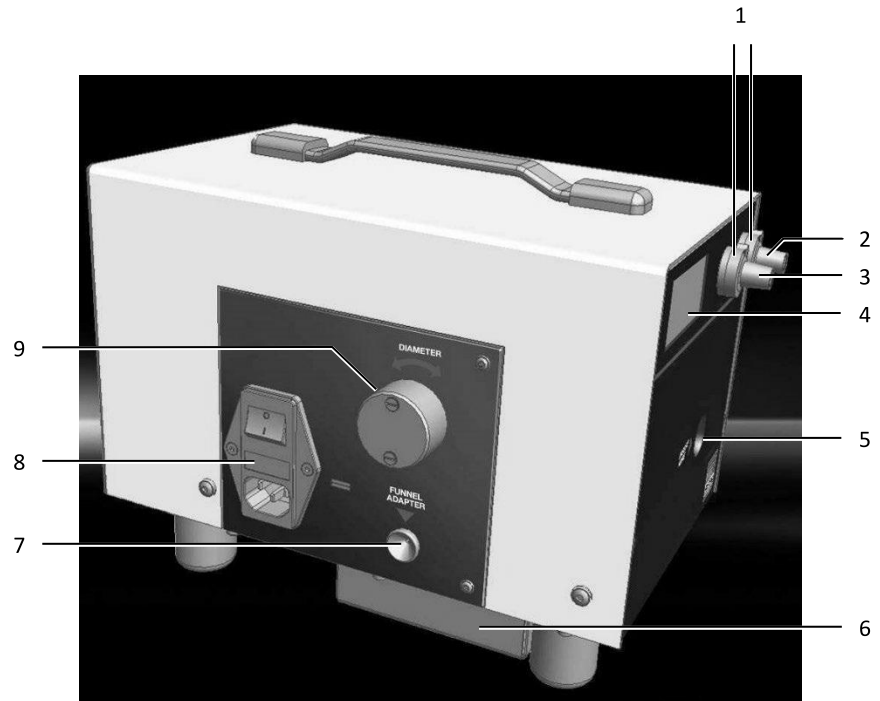

Fig. 1: Overall view

Key

- 1 Touch display
- 2 Brakes
- 3 Draw-off length setting button
- 4 Insulation stripping length setting button
- 5 Insertion funnel
- 6 Stripped insulation scrap container
- 7 Supplementary funnel
- 8 Mains filter
- 9 Cross-section setting button

3.2 Technical data

	AS Stripping machine S22
Feeding length	22 mm + stripping length
Cross-section	0.05...6.0 mm ² (30...10 AWG)
Max. outer diameter	5.1 mm
Stripping length	3...20 mm
Pull-off length	3...20 mm
Drive	Electric motor
Voltage	100...240 V
Frequency	50/60 Hz
Power consumption	45 VA

4 Operating instructions

EN

	AS Stripping machine S22
Fuse (mains filter module)	2 x T2AH250V
Degree of protection	IP 20
Cycle time	approx. 0.5 s
Continuous sound pressure level	≤70 dB(A)
Dimensions (W x D x H)	190 x 295 x 190 mm
Colour	RAL 9003
Weight	7.5 kg
Interfaces	Touch display
Operating environment	
Transport temperature	-25 °C...+55 °C
Ambient temperature	-5 °C...+40 °C
Operating temperature	+10 °C...+45 °C
Max. operating altitude	2000 m above mean sea level
Humidity	50% at 40 °C (without dewing) 90% at 20 °C (without dewing)
Contamination level	2
Pressure safety equipment	85%...110%

4 Operating instructions

4.1 Setting up the machine

- Read the operating instructions carefully before commissioning the machine.
- Deploy the machine only in a dry environment.

Attention!

The electrical data shown on the rating plate must match that of the power grid. Otherwise, damage can occur to the machine.

- Connect the mains cable to the machine and to the power supply.

4.2 Switch on the machine

- Switch on the mains switch at the mains filter module.

4.3 Setting the length unit (mm or inch)

- Press the touch display briefly.



- Press the touch display and keep pressed for at least 5 seconds. The length unit switches.



4.4 Setting the cross-section

- Turn the setting button for the cross-section until the display shows the desired cross-section.

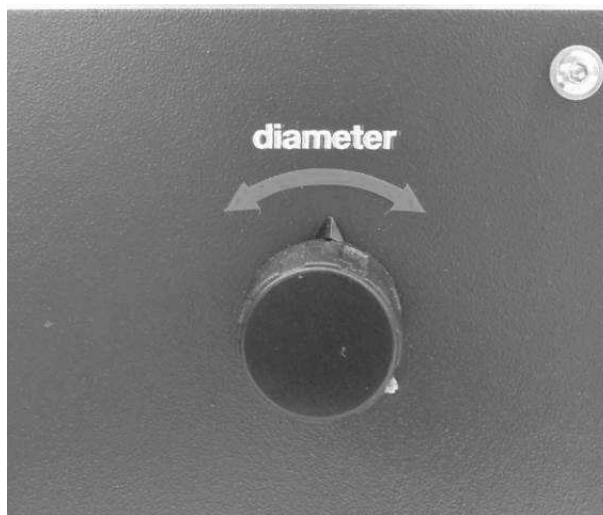

Fig. 2: Setting button

- Depending on the wire properties, a small readjustment may be needed.



Note:

Insert the supplementary funnel in the feed funnel for wire cross-sections from 0.05 – 0.34 mm².



4.5 Setting the stripping length

- Release the brake (fig. 3, item 1) of the setting button by turning it counter-clockwise.

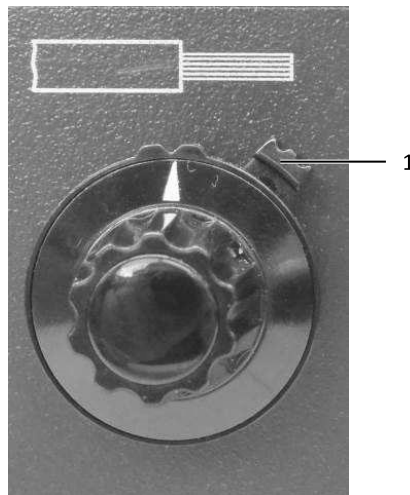

Fig. 3: Brake at the setting button

- Set the stripping length (fig. 4, item 2) via the setting button (length in mm, guide value).



Fig. 4: Stripping length in the display

- Apply the brake.

4.6 Setting the draw-off length

- Release the brake (fig. 5, item 1) of the setting button by turning it counter-clockwise.

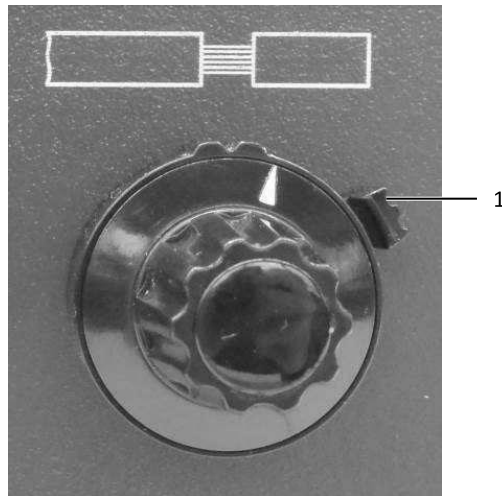

Fig. 5: Brake at the setting button

- Set the draw-off length (fig. 6, item 2) via the setting button (length in mm, guide value).



Fig. 6: Draw-off length in the display

- Apply the brake.

4.7 Wire entry







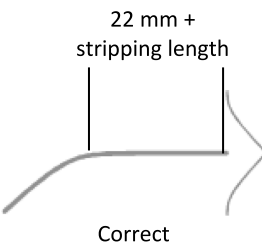

Note:

- The cable must be cut straight and must not have any kinks or bends.
- Inserting the wire in the insertion funnel triggers the work cycle.

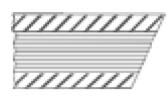
4 Operating instructions

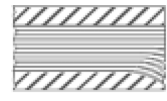
EN

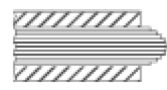
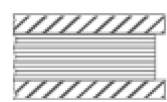
	Correct	Incorrect	
 <p>22 mm + stripping length</p> <p>Correct</p>			Inclined cut
 <p>Incorrect</p>			Protected conductor
			Pulled-out conductor
			Crushed conductor
			Recessed conductor

Tab. 1: Wire entry

4.8 Menu

4.8.1 "Display" menu: Automatic work menu



Fig. 7: "Display" menu

Key

- 1 Stripping length
- 2 Pull-off length
- 3 Menu
- 4 AWG
- 5 Cross-section

4.8.2 "Manual" menu (manual control for removing the stripped insulation scrap)



- Start manual cycle. To do this, press the touch display briefly. The display switches automatically to menu 1.

Manual mode

- Keep the touch display pressed during switch on.
Menu 2 "Manual" is displayed flashing.
- In manual mode, the motor can be adjusted slowly with touch contact during jogging.
- If the touch display is pressed for at least 3 seconds, a switch is made back to menu 1 "Display".

4.8.3 "Counter" menu

- Select menu 3 "Counter" To do this, press the touch display for at least 3 seconds.

Symbol	Description
	Total counter
	Day counter
	Service counter

- Exit the menu: press the touch display briefly.
- Clear the day counter: press the touch display for at least 3 seconds.
- When starting the insulation stripping, the menu is exited automatically and menu 1 selected.

5 Maintenance



- Caution!
Risk of injury at the blades.
- Never touch the blades.

5.1 Emptying the stripped insulation scrap container

- Withdraw the stripped insulation scrap container, empty it and reinsert it to the limit stop.

5.2 Interior



Note:
The machine interior should be cleaned and oiled in six-monthly intervals or after 50,000 – 100,000 activations.

- Loosen the screws and remove the front panel.
- Remove the stripped insulation scrap and any contamination.
- Oil very sparingly the wire-holding pliers (inner side of the front plate) and the pressure-ball screws (fig. 9) with standard motor oil.
- Close the front panel. To do this:
 - Push the actuator level to the left.
 - Place the front panel and, by moving from right to left, fasten it to the front frame of the machine (attach with the alignment pin on the right-hand side).
 - Fasten the front panel with the screws.

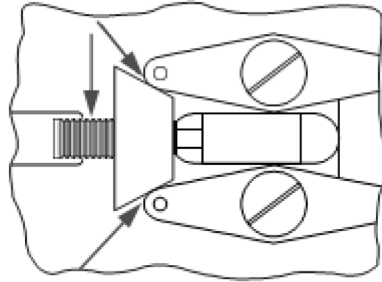

Fig. 8: Wire-holding pliers

5.3 Replacing the insulation stripping blade



Warning!

Electrical shock caused by working on live components!

- Before working on the machine, it must be disconnected from the power grid.

- Loosen the screws and remove the front panel.
- Loosen the fastening screws and remove the blade fastener.
- Either turn the insulation stripping blade or replace it with a new one. Reinsert the blade fastener and tighten the fastening screws.

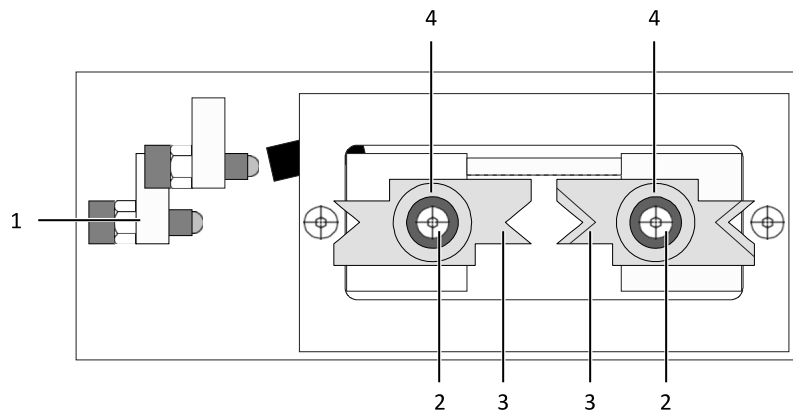

Fig. 9: Interior view

Key

- 1 Actuator lever with ball-pressure screws
- 2 Fastening screw
- 3 Insulation stripping blade
- 4 Blade fastener

- Close the front panel. To do this:
 - Push the actuator level to the left.
 - Place the front panel and, by moving from right to left, fasten it to the front frame of the machine (attach with the alignment pin on the right-hand side).
 - Fasten the front panel with the screws.

6 Troubleshooting

6.1 Machine does not start

The power supply is interrupted.

- Check the mains cable and the fuses.

6.2 No start for inserted wire

Start sensor (S1) is blocked with stripped insulation scrap.

- Press the "Manual cycle" touch display briefly.

Wire inserted incorrectly.

- Insert the wire as described in section 4.7 "Wire entry".

6.3 Larger number of rejects

The stripped insulation scrap container is full.

- Empty the stripped insulation scrap container.

Cross-section setting button adjusted.

- Check the setting



Insulation stripping blade damaged or installed incorrectly.

- Repair or replace blade.

6.4 Error messages

Flashing error messages in the touch display.

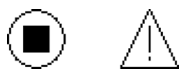
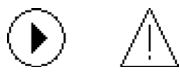
- To acknowledge, press the touch display briefly.

Symbol	Description
	Stop switch fault The Stop switch does not switch or remains pressed.
	Start switch fault Start switch not free.
	Motor fault The motor does not run or jams (current too high).
	Service message Service quantity attained.

7 Electrical connection diagram

EN

7 Electrical connection diagram

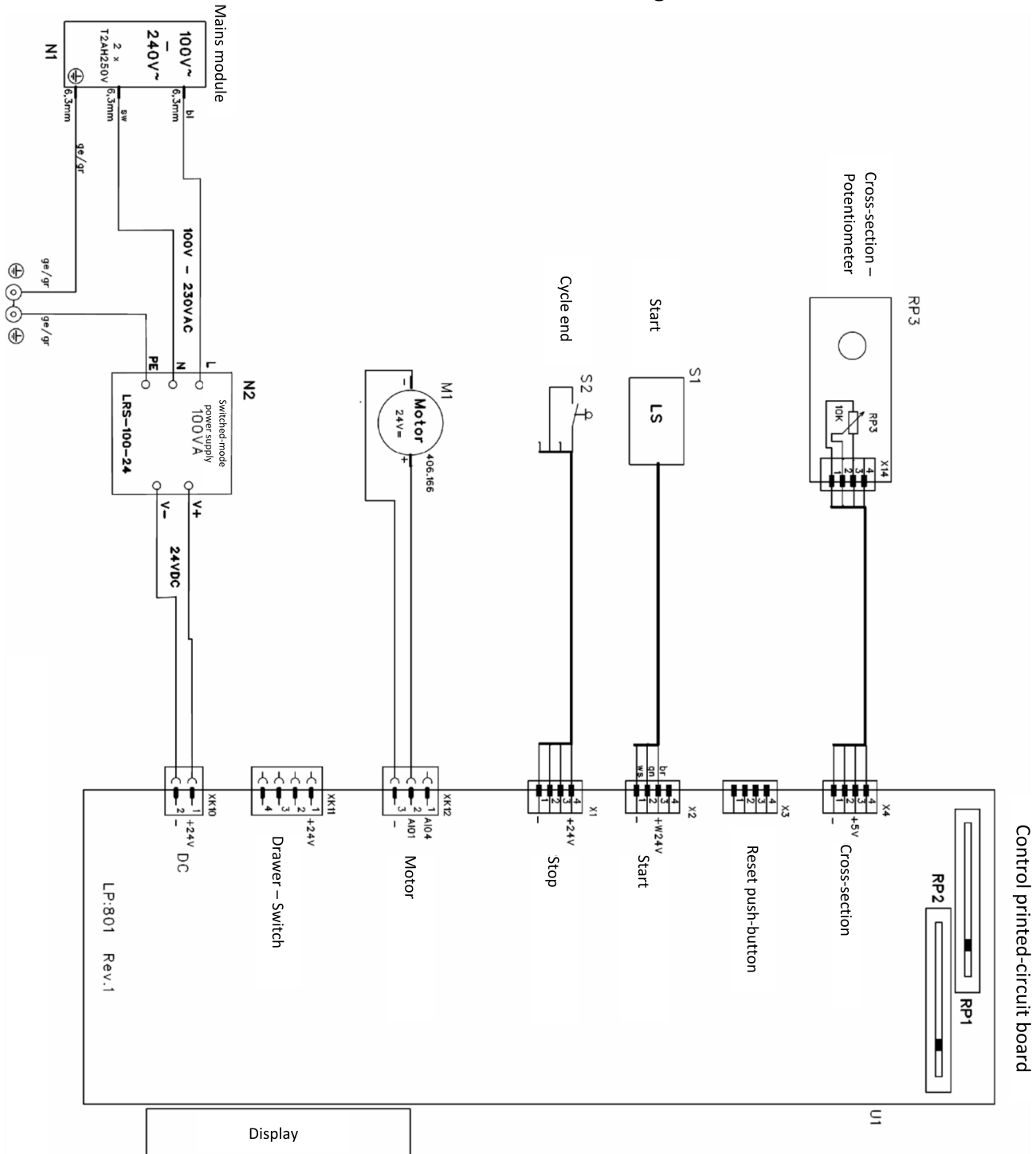

8 Spare parts

Designation	Model no.
AS Insulation stripping blade kit, V-blade, titanium	4050464

9 Disposal



Machine disposal as house refuse is not permitted. The machine should be disposed of environmentally conform and properly. The local waste disposal regulations and the legal requirements for disposal must be observed.

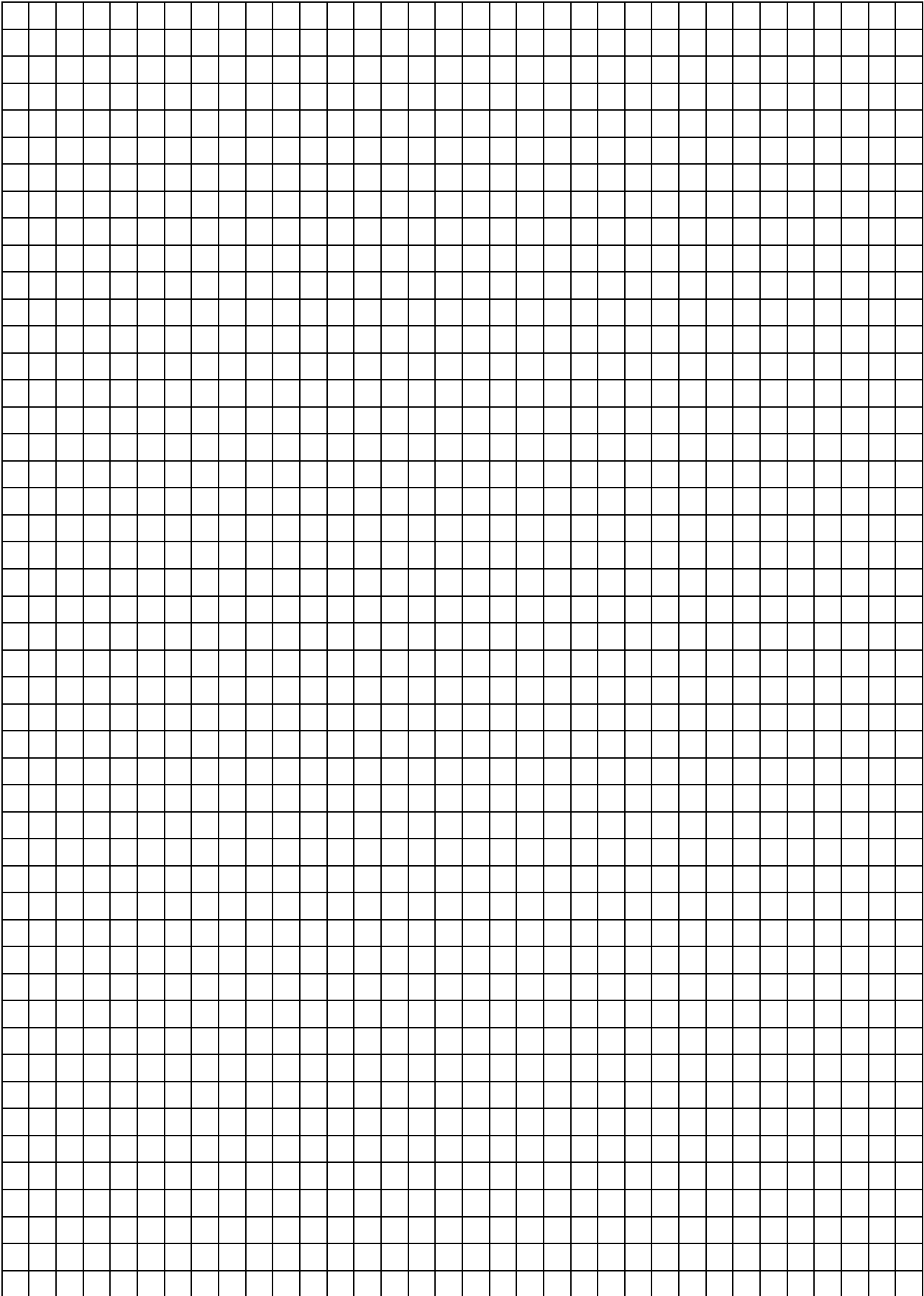

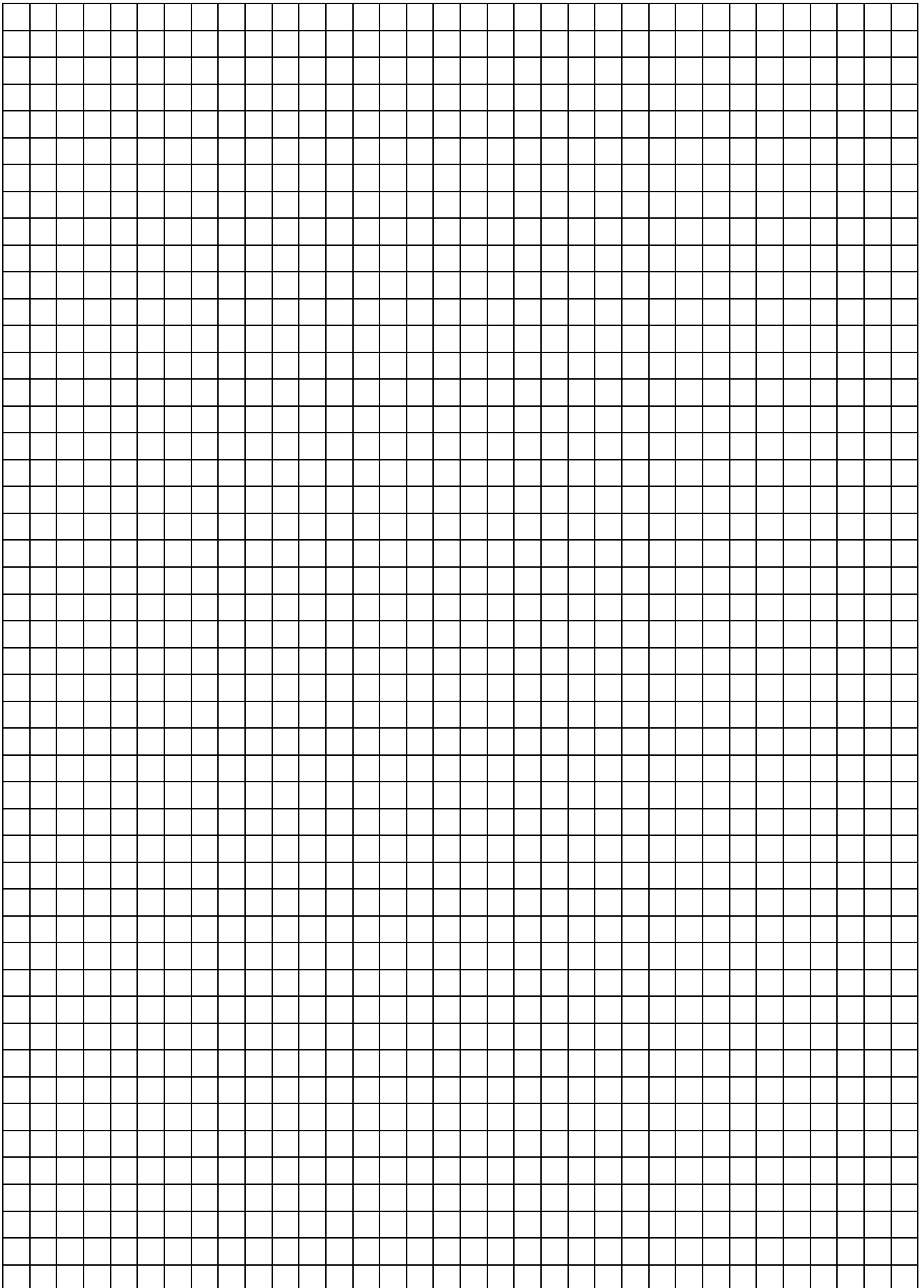

Notes

EN

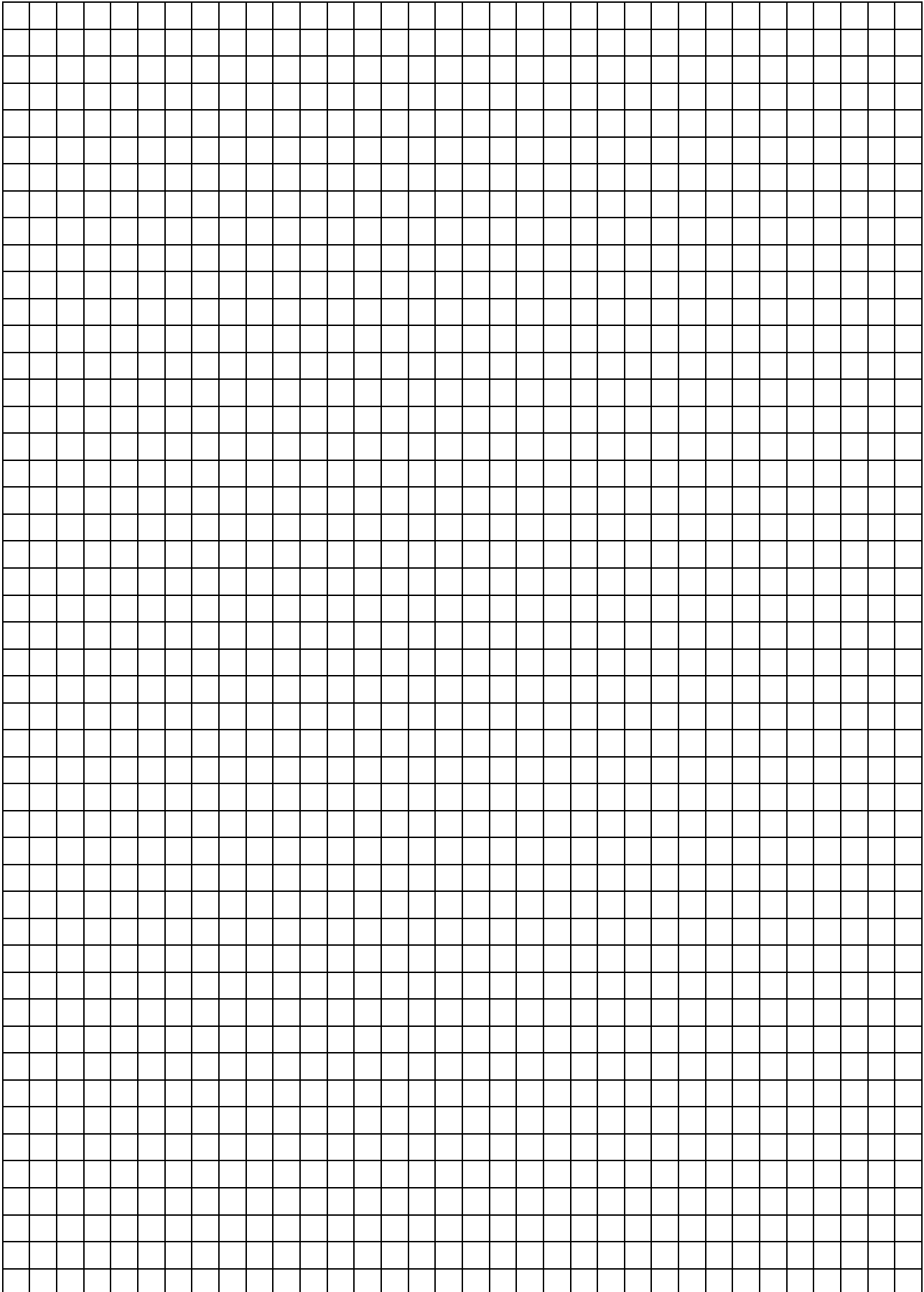

Rittal – The System.

Faster – better – everywhere.

- Enclosures
- Power Distribution
- Climate Control
- IT Infrastructure
- Software & Services

You can find the contact details of all Rittal companies throughout the world here.



www.rittal.com/contact

RITTAL GmbH & Co. KG
Auf dem Stuetzelberg · 35745 Herborn · Germany
Phone +49 2772 505-0
E-mail: info@rittal.de · www.rittal.com

10.2021 / D-0100-00000029-02-EN

ENCLOSURES

POWER DISTRIBUTION

CLIMATE CONTROL

IT INFRASTRUCTURE

SOFTWARE & SERVICES

FRIEDHELM LOH GROUP

