

$M_A = 6 \text{ Nm}$

$M_A = 45 \pm 5 \text{ Nm}$

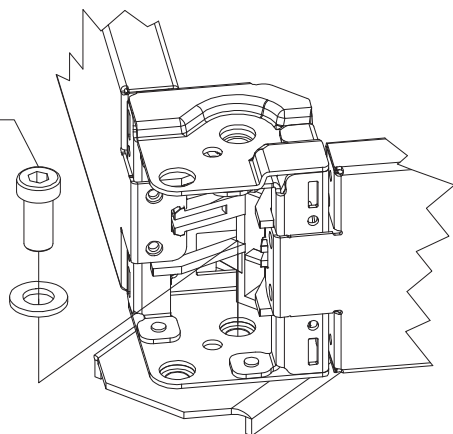

VX

8100.770

4x



M12

4x



A13

4x

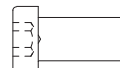

M12x25

4x



M5x12

Zchng.-Nr. / No. of dwg. : A08282900VX

Versandbeutel-Nr. / No. of accessory bag : 375334

Lieferanten-Nr. / No. of supplier : 6045700

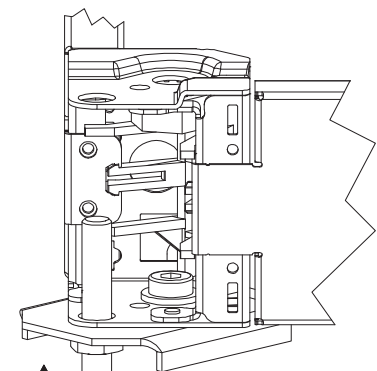

$M_A = 45 \pm 5 \text{ Nm}$

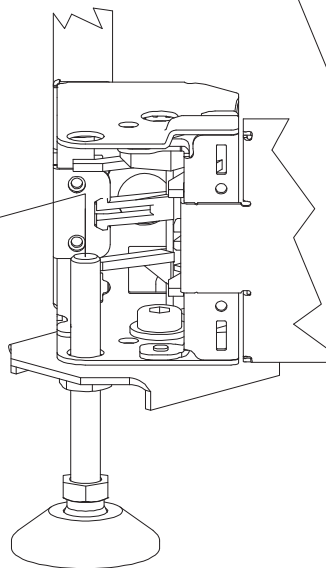

$M_A = 45 \pm 5 \text{ Nm}$

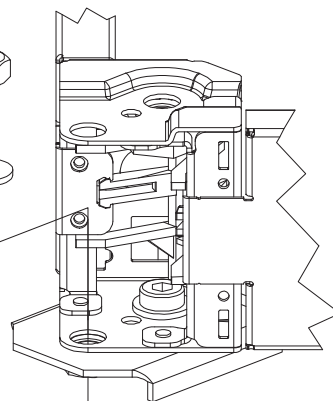
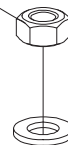

$M_A = 45 \pm 5 \text{ Nm}$

