

# Rittal – The System.

Faster – better – everywhere.

## Secarex AC 18 cutting centre



4050.418

## Operating instructions

ENCLOSURES

POWER DISTRIBUTION

CLIMATE CONTROL

IT INFRASTRUCTURE

SOFTWARE & SERVICES

FRIEDHELM LOH GROUP



## **Foreword**

Dear Customer,

We thank you for choosing our "Secarex AC 18" cutting centre!

We wish you every success!

Yours,  
Rittal GmbH & Co. KG

Rittal GmbH & Co. KG  
Auf dem Stützelberg

35745 Herborn  
Germany

Tel.: +49(0)2772 505-0  
Fax: +49(0)2772 505-2319

E-mail: [info@rittal.de](mailto:info@rittal.de)  
[www.rittal.com](http://www.rittal.com)

We are always happy to answer any technical questions regarding our entire range of products.

## Contents

1	Notes on the documentation .....	5
1.1	CE label .....	5
1.2	Storing the documents .....	5
1.3	Symbols used in these operating instructions .....	5
1.4	Associated documents .....	5
2	Safety instructions .....	6
2.1	General safety instructions .....	6
2.2	Responsibilities of the operating company .....	6
2.3	Operating and specialist personnel .....	7
2.4	Personal protective equipment.....	7
2.5	Residual risks for use of the Secarex AC 18.....	7
3	Product description .....	9
3.1	Functional description and components.....	9
3.1.1	Identification .....	9
3.1.2	Function .....	9
3.1.3	Components .....	9
3.1.4	Control components .....	10
3.1.5	Safety and warning components .....	11
3.2	Proper use, foreseeable misuse .....	12
3.3	Standing area of the user.....	13
3.4	Scope of supply.....	13
4	Transport and handling .....	14
4.1	Delivery.....	14
4.2	Transport.....	14
5	Installation and commissioning .....	15
5.1	Safety instructions .....	15
5.2	Installation site requirements.....	15
5.3	Installation procedure.....	16
5.4	Installation of the machine.....	16
5.5	Connecting the compressed-air supply.....	16
5.6	Connecting the mains power supply .....	17
5.7	Network connection.....	17
5.8	Connecting the label printer .....	18
5.9	Switching on the machine.....	18
5.10	Switching off the machine.....	18
6	Working with the machine .....	19
6.1	General information.....	19
6.2	Structure of the Secarex software.....	19
6.2.1	Basic operation .....	19
6.2.2	Structure of the Secarex software .....	19
6.2.3	Layout of the screens .....	19
6.2.4	Login and logout .....	20
6.3	Production.....	21
6.3.1	General information .....	21
6.3.2	Creating a production list .....	22
6.3.3	Viewing the bill of materials .....	26
6.3.4	Machining (operation) .....	27
6.3.5	Cancelling and resuming a machining operation .....	31
6.3.6	Manual operation .....	32
6.4	Working with CSV files.....	32
6.4.1	General information .....	32
6.4.2	Structure of the CSV file .....	32
6.4.3	Importing a CSV file .....	33

6.5	Importing a text file.....	34
6.5.1	General .....	34
6.5.2	Structure of the text file .....	34
6.5.3	Importing a text file .....	34
6.6	PPR import .....	34
6.6.1	General .....	34
6.6.2	Importing a PPR file .....	35
6.7	History .....	35
6.7.1	General .....	35
6.7.2	Filtering the entries .....	35
6.7.3	Exporting the history .....	35
6.8	User administration .....	36
6.8.1	Creating a user .....	36
6.8.2	Deleting a user .....	37
6.8.3	Changing the password .....	37
6.8.4	Changing the user role .....	38
6.9	Service.....	38
6.10	Configuration .....	38
6.10.1	General information .....	38
6.10.2	Machine .....	38
6.10.3	Software .....	41
7	Maintenance .....	44
7.1	Safety instructions concerning maintenance work.....	44
7.2	Overall maintenance plan .....	44
7.3	Tests .....	45
7.3.1	Compressed-air maintenance unit .....	45
7.3.2	Linear unit of the feed .....	46
7.3.3	Cutting tools .....	46
7.3.4	Electrical system .....	46
7.4	Cleaning .....	46
7.4.1	Complete machine .....	46
7.4.2	Linear guides .....	47
7.4.3	Cutting tools, including the guides .....	47
7.4.4	Compressed-air maintenance unit .....	49
7.4.5	Viewing window .....	49
7.5	Lubrication.....	49
7.5.1	Linear guides .....	49
7.5.2	Track tool .....	49
7.6	Replacement .....	50
7.6.1	Duct tool .....	50
7.6.2	Track tool .....	52
8	Technical specifications .....	55
9	Decommissioning and disposal .....	56
9.1	Decommissioning .....	56
9.2	Disposal.....	56

## 1 Notes on the documentation

### 1.1 CE label

Rittal hereby confirms that the Secarex AC 18 cutting centre is compliant with the EC Machine Directive 2006/42/EC. An appropriate declaration of conformity has been issued.



### 1.2 Storing the documents

These operating instructions, together with all applicable documents, are integral components of the product. They must be issued to everyone who works with the machine and must always be available and on hand for the operating and maintenance personnel.

### 1.3 Symbols used in these operating instructions

The following symbols are used in this documentation:

**Danger!**

**Hazardous situation which will result in death or serious injury if the instructions are not followed.**

**Warning!**

**Hazardous situation which may lead to death or serious injury if the instructions are not followed.**

**Caution!**

**Hazardous situation which may lead to (minor) injuries if the instructions are not followed.**

**Note:**

Identification of situations that can lead to material damage.

- This symbol indicates an "action point" and shows that you should perform an operation or procedure.

### 1.4 Associated documents

In addition to the provided operating instructions, the documentation folder with the operating instructions of the deployed components belongs to the complete documentation of the Secarex AC 18.

## 2 Safety instructions

### 2.1 General safety instructions

Please observe the following general safety instructions for the installation and operation of the Secarex AC 18:

- Other than these general safety instructions, ensure you also observe the specific safety instructions when performing the tasks described in the following chapters.
- The Secarex AC 18 is conceived as a single workplace; only one person can operate the machine.
- Please observe the valid regulations for electrical installation in the country in which the Secarex AC 18 is installed and operated, and the national regulations for accident prevention. Please also observe any internal company regulations, such as work, operating and safety regulations.
- Use only original Rittal products or products recommended by Rittal in conjunction with the Secarex AC 18.
- Do not make any changes to the Secarex AC 18 not described in these or the associated operating instructions.
- The operational safety of the Secarex AC 18 is guaranteed only when used properly for the intended purpose. The technical specifications and limit values stated must not be exceeded under any circumstances.
- Operating the system in direct contact with water, aggressive materials or inflammable gases and vapours is prohibited.
- Anyone involved with the operation or maintenance of the Secarex AC 18 must have read and understood the complete operating instructions.
- The switch-off procedures specified in the operating instructions must be observed.
- Any operation that impairs the safety of the operator or the Secarex AC 18 is prohibited.
- All unauthorised changes and modifications that can affect the safety of the operator or the Secarex AC 18 are prohibited.
- Changes made to the controller by the customer are permitted only with the consent of Rittal. Unauthorised changes void the warranty.
- No project documents may be forwarded to third-parties.
- Media must be supplied (e.g. compressed-air supply) in accordance with the information provided in these operating instructions.

### 2.2 Responsibilities of the operating company

- The company operating the Secarex AC 18 is responsible for always operating it in good technical state.
- The company operating the Secarex AC 18 is recommended to obtain a written confirmation from all operating personnel that they have read and understood the complete operating instructions.
- The operating company is required to inform all operating personnel concerning danger sources that can result from working with the Secarex AC 18.
- The operating company is responsible for prohibiting unauthorised personnel from having access to the Secarex AC 18. This may include the creation of a permanent access restriction.

The operating company is also obliged to create operating instructions that are available at the workplace. These operating instructions should be oriented on the worker protection laws and must contain at least the following passages:

- Work on electrical equipment may be undertaken only by qualified electricians.
- Prior to any work being performed on the electrical equipment of the Secarex AC 18, the master switch must be switched off by the professionally competent supervisor and be protected with a lock from being switched on again. The key is removed and retained by the supervisor.

- After completion of the work and before switching on again, the responsible supervisor ensures that this is possible without endangering personnel and equipment. Prior to switching on, a timely and clear warning must be issued to all involved persons.
- Operation of the Secarex AC 18 is permitted only when the personnel uses the prescribed personal protective equipment. In particular, this also applies to maintenance and repair work.

### 2.3 Operating and specialist personnel

Although the Secarex AC 18 is a state-of-the-art machine that is safe to operate, it can be a source of danger if it is operated incorrectly by untrained personnel or used for a purpose for which it is not intended.

- The assembly, installation and commissioning of the Secarex AC 18 may be performed only by Rittal or by specialist personnel commissioned by Rittal.
- The Secarex AC 18 may be operated and maintained only by properly trained specialists.
- The operating personnel is informed in the regular training courses on the necessity of wearing the personal protective equipment. They are also informed that working without protective equipment can lead to serious and permanent injuries or illness.
- The assignment of access authorisations for installation, commissioning, operation and repair work must clearly be defined and followed to avoid any ambiguity relating to competence. Basic prerequisite for operating personnel is expertise and experience with modern personal computers and the associated operating system.
- The operating company and all operating personnel are obliged to ensure tidiness and cleanliness at the workplace, in the working environment and the neighbouring access areas.

### 2.4 Personal protective equipment

The operating and maintenance personnel must always wear personal protective equipment when working on the Secarex AC 18. The personal protective equipment comprises of at least the following components:

- Safety work shoes: for all work on the machine.
- Hearing protectors: when cutting workpieces on the machine.
- Strong gloves: for maintenance work in the area of the duct tool, in particular when the housing is removed.

### 2.5 Residual risks for use of the Secarex AC 18

After initiation of the cutting movement, the duct tool travels with two-hand operation. Injuries can result from intervention in the cutting area of the duct tool.

- Ensure that two persons are never working on the machine (see section 3.2 "Proper use, foreseeable misuse").

When cutting wiring ducts, injuries can result from flying offcuts when the blade meets the teeth of the wiring duct.

- Look through the viewing window to ensure that the wiring duct is aligned correctly and the cut is always made between two teeth (see section 6.3.4 "Machining (operation)").

When traversing the stop, there is the risk of jamming between the workpiece and the stop, between the tool and the stop, as well as between the support surface and the stop.

- Ensure that two persons are never working on the machine (see section 3.2 "Proper use, foreseeable misuse").
- To prevent a possible jamming, remove any workpieces from the support before traversing the stop.
- Never perform any actions in the stop area while it is traversing.

## 2 Safety instructions

---

EN

When performing maintenance work, in particular in the area of the duct tool with removed housing, there is the risk of being crushed or cut at the blade.

- Always wear your personal protective equipment for all work performed in the area of the duct tool (see section 2.4 "Personal protective equipment").
- Directly after removing the housing, also place the blade protection on the cutting edge of the duct tool.



### 3 Product description

#### 3.1 Functional description and components

##### 3.1.1 Identification

The type plate of the Secarex AC 18 is located at the rear of the operating panel (fig. 1, item 1).

##### 3.1.2 Function

The Secarex AC 18 is a cutting centre for the (semi-automatic) shortening of wiring ducts, cable duct covers and support rails. For this purpose, two tools and an appropriate stop are mounted on the work table.

##### 3.1.3 Components



Fig. 1: Secarex AC 18 front view

##### Key

- 1 Operator panel with screen, keyboard and trackball
- 2 Label printer
- 3 Automatic length stop
- 4 Support for shortened workpieces
- 5 Operator console (fig. 3)
- 6 Cutting area (fig. 2)
- 7 Adjustable feet
- 8 Master switch
- 9 Duct support
- 10 Support rails support
- 11 "Control voltage On" key



##### Note:

As an option, drawers at the front left and storage bins at the right can be integrated for storage, e.g. of tools or residual material.

## 3 Product description

EN

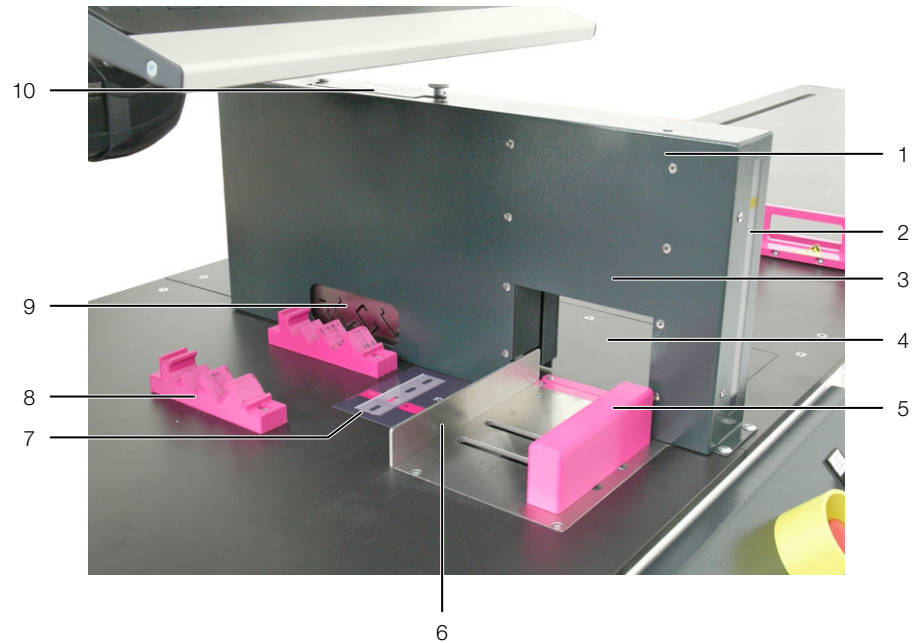

Fig. 2: Cutting area

### Key

- 1 Safety fence of the tools
- 2 Viewing window
- 3 Tool for wiring ducts and cable duct covers
- 4 Counter blade service cover
- 5 Wiring ducts and cable duct covers fixing (replaceable)
- 6 Wiring ducts and cable duct covers rear stop
- 7 System support rails label
- 8 Support rails support
- 9 Tool for support rails with five standard templates
- 10 Service flap (lubrication of the track tool)

### 3.1.4 Control components

In addition to the "Master switch" (item 8) shown in fig. 1, the "Control voltage On" key (item 11) as well as the operator panel (item 1), including the label printer (item 2), the cutting centre has an operator console, located at the front centre of the machine, which is used to initiate the cutting action for the wiring ducts, cable duct covers and support rails.

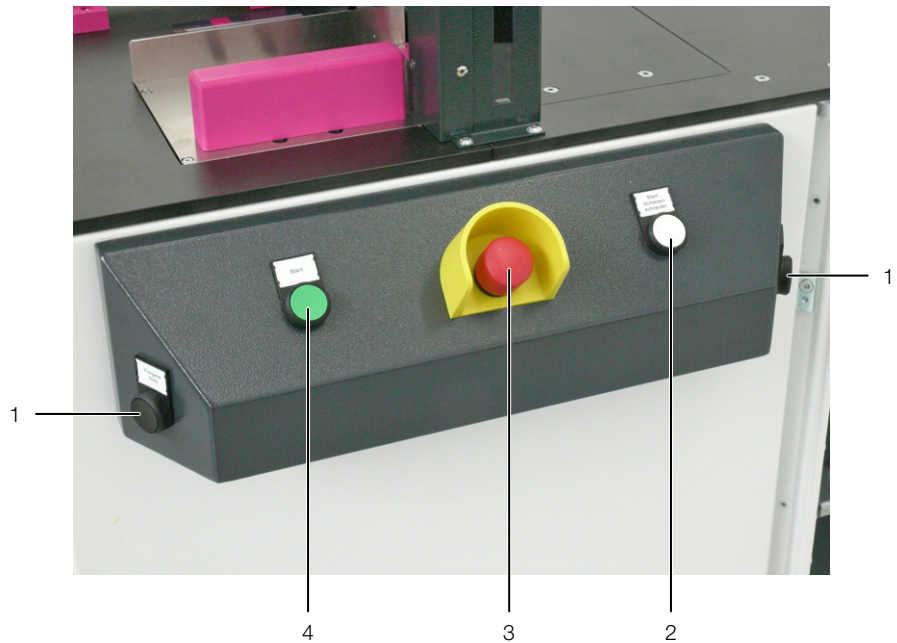

Fig. 3: Control components on the operator console

### Key

- 1 Two-hand keys, "Two-hand duct 1" (left) and "Two-hand duct 2" (right)
- 2 "Start rail cutter" key
- 3 EMERGENCY STOP key
- 4 "Start" key



### Note:

For simplification, the operating instructions use the term "two-hand duct" for both keys. This relates to the two above-mentioned two-hand keys left and right on the operator console.

### 3.1.5 Safety and warning components

The following safety equipment provides protection against personal injury and material damage:

#### Master switch

Activating the black master switch mounted on the front door of the switch cabinet integrated in the Secarex AC 18 switches the power supply to the Secarex AC 18 on or off (fig. 1, item 8).

#### EMERGENCY STOP key

Activating the red EMERGENCY STOP key installed on the operator console interrupts the power supply for all outputs (fig. 3, item 3). The operating panel and the graphical user interface remain switched on.

#### Two-hand operation

Wiring ducts and cable duct covers are cut by pressing and holding down the two "Two-hand duct" start keys simultaneously (fig. 3, item 1).

#### Warning signs on the Secarex AC 18

The following warning signs are provided on the Secarex AC 18:

- "Ear muffs" mandatory sign on the operating panel
- "Risk of jamming" warning sign at the automatic length stop
- "Grease gun" symbol on the service flap for lubricating the track tool

- "Warning of a dangerous electrical voltage" warning sign on the enclosure door as well as inside the enclosure on the permanently energised sockets.

### 3.2 Proper use, foreseeable misuse

The Secarex AC 18 is a cutting centre for the (semi-automatic) cutting of rectangular slitted wiring ducts, cable duct covers and support rails.

The wiring ducts and the associated duct covers must be manufactured from soft non-reinforced plastic. The wall thickness as well as the depth and height must not exceed the values specified in the technical specifications.

The support rails must be made of (galvanised) steel, copper or aluminium. Only those types named in the technical specifications may be cut with Secarex AC 18.

The Secarex AC 18 is conceived as a single workplace. In particular, it is also forbidden for more than one operating person to work on the Secarex AC 18.

The Secarex AC 18 is state-of-the-art and has been built according to recognised safety regulations. Nevertheless, improper use can pose a threat to the life and limb of the user or third-parties, or result in possible damage to the machine and other property.

As such, the Secarex AC 18 must only be used as intended and while in a perfect technical condition! Any malfunctions that impair safety must be rectified immediately!

Proper use also includes the observance of the provided documentation and compliance with the inspection and maintenance conditions.

Rittal is not liable for any damage which may result from failure to comply with the provided documentation. The same applies to failure to comply with the valid documentation for any accessories used (see section 1.4 "Associated documents").

Improper use may cause hazards. A foreseeable misuse of the Secarex AC 18 is the operation of the machine under the following conditions:

- Machining of support rails with the tool for wiring ducts or cable duct covers.
- In an imperfect state (with obvious faults or severe contaminations).
- With removed protective covers.
- Unauthorised in service operation.
- In an explosive environment.
- Outside the specified environmental conditions.
- After unauthorised changes or revisions to the machine.
- Non-observance of the safety instructions and the operating notes.
- When using non-approved materials, operating supplies or accessories.
- Non-observance of the worker protection and accident prevention regulations.
- Non-observance of the legal regulations.
- Non-observance of the permitted restrictions and limits, in particular exceeding the maximum dimensions of the machined workpieces.

Furthermore, an improper use can include:

- Use of impermissible tools.
- Improper operation.
- Improper rectification of malfunctions.
- Use of accessories not approved by Rittal.

## 3.3 Standing area of the user

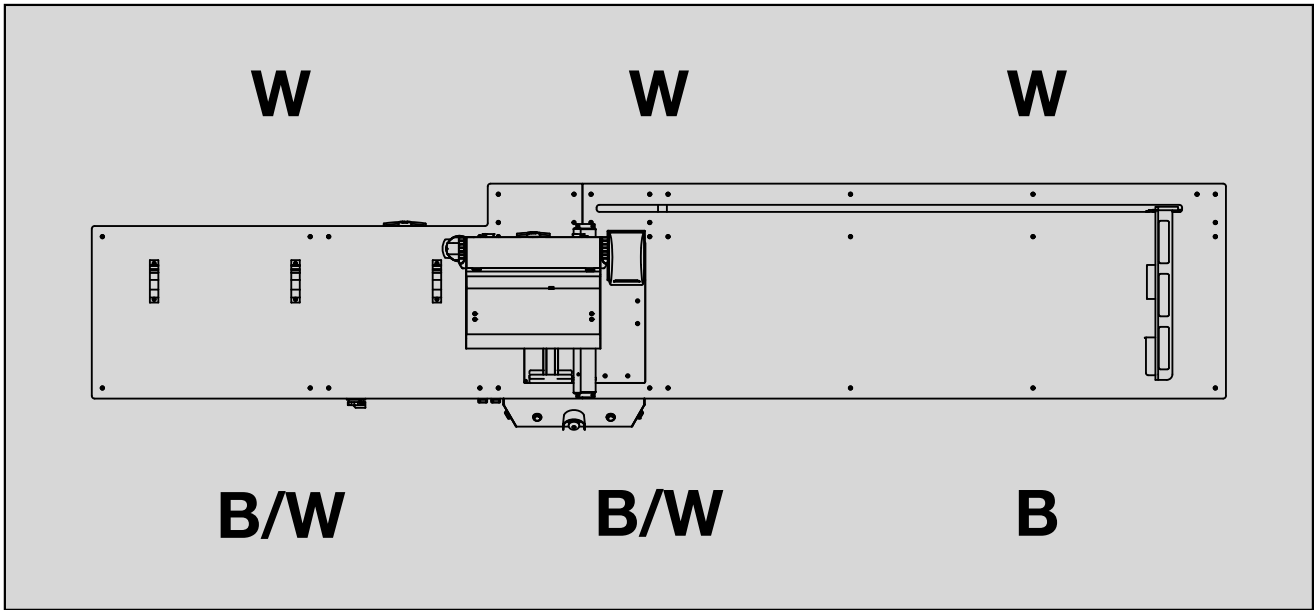

Fig. 4: Standing area of the user

### Key

- B Standing area for operation
- W Standing area for maintenance

For operation, the operating personnel stands only in front of the machine, where all control components are also located.

For maintenance work, the maintenance personnel also stands behind the machine, where, for example, the drive unit for the automatic length stop is located.

## 3.4 Scope of supply

Quantity	Designation
1	Secarex AC 18 cutting centre
1	Document folder, including the operating instructions
1	Label printer

Tab. 1: Scope of supply

## 4 Transport and handling



### Warning!

#### Injury due to falling suspended loads!

**For inadequately secured suspended loads, incorrectly placed hoisting gear or unfavourable centre of gravity there is the danger of injury due to falling loads.**

**Ensure that no persons are standing under or near a suspended load!**

### 4.1 Delivery

The Secarex AC 18 is delivered in one packaging unit.

- Check the packaging carefully for signs of damage.

Any packaging damage may be the cause of a subsequent functional failure.



#### Note:

After unpacking, the packaging materials must be disposed of in an environmentally friendly way. They consist of the following materials: Wood, polyethylene film (PE film), cardboard, plastic (straps).

- Check the Secarex AC 18 for any damage that may have occurred during transport.



#### Note:

Damage and other faults, e.g. incomplete delivery, should be reported immediately, in writing, to the shipping company and to Rittal.

- Please check the scope of supply for completeness (see section 3.4 "Scope of supply").

### 4.2 Transport



#### Note:

There is danger of damaging the machine at the left and right-hand sides when lifting the Secarex AC 18.

Transport the machine only as described in the following section.

- Even after delivery, transport the Secarex AC 18 on the wooden frame or in the packaging to the vicinity of the final installation site.
- To do this, lift the Secarex AC 18 with a fork lift from the front or rear centred under the wooden frame.
- Alternatively, lift the Secarex AC 18 with **two** hoist trolleys also under the wooden frame.  
Whereby, one hoist trolley grips from the left under the wooden frame and the other one from the right.
- When using two hoist trolleys, to prevent the machine from falling, ensure the synchronous movement of both hoist trolleys.
- Ensure that at no time, even briefly, are any persons standing under a suspended load.

## 5 Installation and commissioning

### 5.1 Safety instructions



**Warning!**

**The complete installation and commissioning of the system may be performed only by Rittal or by specialist personnel commissioned by Rittal.**



**Warning!**

**Work on electrical systems or equipment may be performed only by an electrician or by trained personnel under the guidance and supervision of an electrician. All work must be performed in accordance with electrical engineering regulations.**

**The Secarex AC 18 may be connected only after the aforementioned personnel have read this information!**

**Use only insulated tools.**

**Follow the connection regulations of the appropriate electrical power company.**

**The Secarex AC 18 is not de-energised until all of the voltage sources have been disconnected!**

- Please observe the valid regulations for electrical installation in the country in which the Secarex AC 18 is installed and operated, and the national regulations for accident prevention.
- Please also observe any internal company regulations, such as work, operating and safety regulations.

### 5.2 Installation site requirements

When choosing the installation site for the Secarex AC 18, please observe the following notes:

- The chosen installation site must provide adequate space for the Secarex AC 18.
- In addition, a clearance of at least 1000 mm should be provided at both sides and in front of the Secarex AC 18 to allow the handling with the wiring ducts, cable duct covers and support rails.
- Furthermore, access from the rear must be provided for maintenance work. If necessary, it must be possible to pull the machine forwards if it is located directly against a wall.
- The installation site must be free from excessive dirt and moisture.
- The ambient temperature must lie within the limit values indicated in the technical specifications.
- The mains connection data as contained in the connection diagram for the Secarex AC 18 or in the technical specifications must be guaranteed.

#### **Electromagnetic interference**

- Interfering electrical installations (high frequency) must be prevented.

## Location of the connection points

The connection points for supplying the Secarex AC 18 with the required media are located at the front of the machine behind the access doors of the enclosure or the pneumatic cabinet. The supply cables can be introduced into the machine from below:

- Front left in the enclosure: Mains voltage
- Front left in the pneumatic cabinet: Compressed air

## 5.3 Installation procedure

The Secarex AC 18 is delivered completely installed. An installation of the machine components is not required.

## 5.4 Installation of the machine



### Warning!

#### Injury due to falling suspended loads!

**For inadequately secured suspended loads, incorrectly placed hoisting gear or unfavourable centre of gravity, there is the danger of injury due to falling loads.**

**Ensure that no persons are standing under or near a suspended load!**



### Note:

There is danger of damaging the machine at the left and right-hand sides when lifting the Secarex AC 18.

Install the machine only as described in the following section.

For the actual installation, the machine must be lifted off the wooden frame on which it is placed for transport.

- Loosen the straps used to secure the machine to the wooden frame.
- Move a fork lift from the front or rear centred between the machine frame and the wooden frame.
- Lift the machine and then lower it slowly and carefully from the wooden frame.
- Place the machine at its final installation location.
- Align the machine using the adjustment feet (fig. 1, item 7) horizontally in all directions.



### Note:

For short distances, e.g. when moving within a company site, the machine can also be transported using two hoist trolleys. Whereby, one hoist trolley grips from the left under the wooden frame and the other hoist trolley from the right.

## 5.5 Connecting the compressed-air supply

The pneumatic cabinet contains a compressed-air maintenance unit to which the compressed-air supply can be connected for driving the cutting tools.

- Open the door of the pneumatic cabinet.
- Lead the pneumatic hose to the compressed air maintenance unit from below.



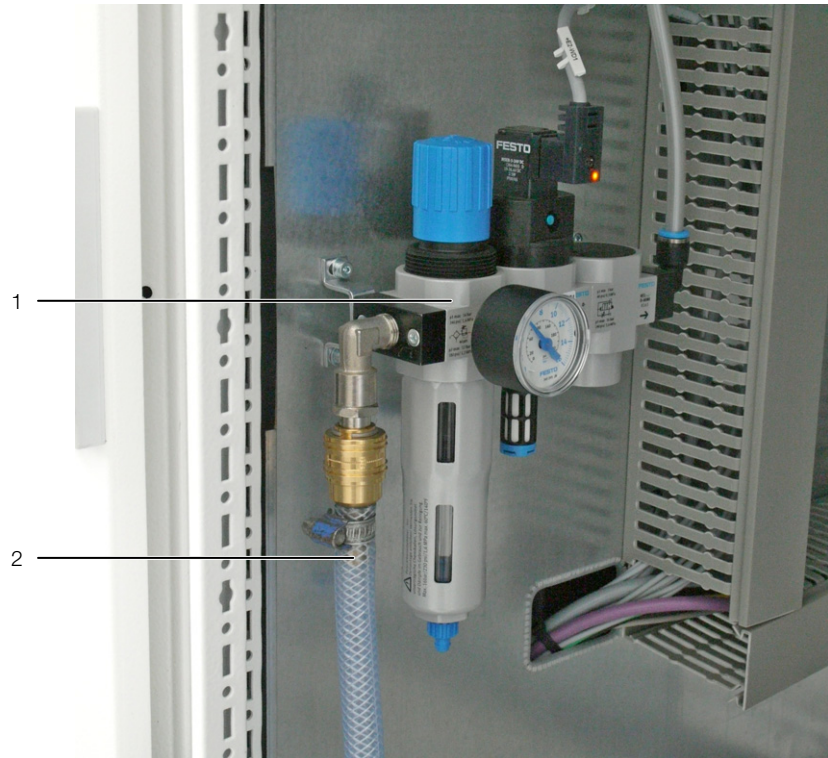

Fig. 5: Pneumatic cabinet

### Key

- 1 Compressed-air maintenance unit
- 2 Compressed-air supply hose

- Set a pressure of 6 bar at the control valve.
- Close the door of the pneumatic cabinet or connect the voltage supply.

## 5.6 Connecting the mains power supply

The enclosure contains the connection point for the mains power supply in a separate connection box. The connection box is located on the left-hand side panel of the enclosure; the connection point is marked with "X01".

- Open the enclosure door.
- Insert upwards the connection cable, and possibly the network cable (see section 5.7 "Network connection"), through the two grommets in the floor of the enclosure.
- Connect the in-house mains power supply with a connection cable to the connection point in the connection box.
- Observe the circuit diagram that accompanies the machine as well as the connection data (see section 8 "Technical specifications").
- Close the enclosure door.

## 5.7 Network connection

The Secarex application on the operating panel requires a network connection to the control unit in the enclosure (PLC). For this purpose, a network cable (at least Cat5e or higher) is connected to the PLC in the enclosure and to the PC. A fixed IP address for the LAN connection must be specified on the operating panel because otherwise the software cannot communicate with the PLC. The IP address is 172.16.5.100 The default address of the PLC is 172.16.5.66

To access a database with machining data present in the network, an appropriate network connection must also be established to the company network.

## Connection to the company network

- Connect the second network socket on the PC with a network cable (at least Cat5e or higher) with your company network.
- If required, assign a fixed IP address.

## 5.8 Connecting the label printer

If the machine is equipped subsequently with a label printer, it must be connected to the operating panel.

- Connect the label printer to a free USB connection on the operating panel.
- Activate the label printer in the Secarex software when an appropriate label should be printed for each workpiece (see section 6.10.3 "Software").

## 5.9 Switching on the machine

Always proceed in the following sequence when switching on the Secarex AC 18:

- Ensure that no workpieces are present on the machine.
- Unlock the EMERGENCY STOP key of the Secarex AC 18 at the front on the operating console.
- Turn the master switch on the enclosure of the Secarex AC 18 from the "OFF/0" position (horizontal) clockwise to the "ON/I" position (vertical).
- Press the "Control voltage On" key on the upper operator panel to start the PLC.  
The key illuminates green continuously.
- Start the Secarex application by clicking the appropriate icon on the desktop of the operating panel.

## 5.10 Switching off the machine

Always proceed in the following sequence when switching off the Secarex AC 18:

- Ensure that no workpieces are present on the machine and that all running machining operations have completed or terminated completely.
- Terminate the Secarex application and shutdown the Windows operating system.
- Press the "Control voltage On" key on the upper operator panel.  
The key no longer illuminates.
- Turn the master switch on the enclosure of the Secarex AC 18 from the "ON/I" position (vertical) counter-clockwise to the "OFF/0" position (horizontal).



---

### Note:

Before switching the machine off, ensure that the operating system has shut down completely. When switching the machine off only via the master switch, data loss can occur and communications problems between the Secarex software and the PLC can result when the machine is switched on again.

---

## 6 Working with the machine

### 6.1 General information

The Secarex AC 18 is equipped with an operating panel. All inputs are made via a keyboard and a trackball (mouse optional). For safety reasons, the actual shortening of the workpieces is made using one or two keys on the operator console of the machine.

To perform the waste optimisation, the following steps are also performed in addition to the actual shortening.

- **First cut:** To obtain a defined start point for a component (wiring duct or support rail), a first cut must be performed. Whereby, the distance from the duct start is matched to the first hole at the drilling pattern of the Perforex machine. After the first cut, the machine can calculate the exact position of the hole pattern. The first cut is a free cut. The operator positions the first cut.

To position the first cut for **support rails**, a label (fig. 2, item 7) that marks the contact point is located in the area of the support for support rails on the desktop.

The first cut for **wiring ducts** is positioned by looking through the viewing window (fig. 2, item 2) in the safety fence of the tools.

- **Intermediate cut:** If several cuts are made from a single raw part, the alignment to the hole pattern of the wiring duct is repeated for every cut. Unlike the first cut, the intermediate cut is calculated automatically by the Secarex software and prepositioned appropriately by the machine.

### 6.2 Structure of the Secarex software

#### 6.2.1 Basic operation

All inputs for working with the Secarex software are made with the keyboard or the trackball on the operator panel.

#### 6.2.2 Structure of the Secarex software

The Secarex software is divided into various areas for each associated topic.

- **Production:** Machining operations are prepared and executed here. This area is selected automatically after starting the machine (see section 6.3 "Production").
- **Configuration:** Settings made after or during the commissioning of the machine are normally made here (see section 6.10 "Configuration").
- **Service:** The basic settings of the machine can be viewed here. Changes to the values may be made only by Rittal service personnel (see section 6.9 "Service").

#### 6.2.3 Layout of the screens

The individual screens, independent of the associated selected area (see section 6.2.2 "Structure of the Secarex software"), always have the same layout.

# 6 Working with the machine

EN

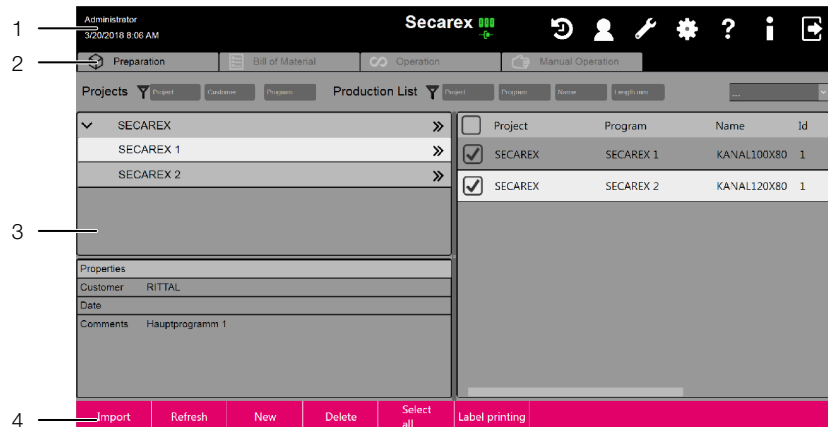

Fig. 6: Layout of the screens

## Key

- 1 Header line
- 2 Tabs
- 3 Main area
- 4 Buttons

The logged in user as well as the date and time are displayed in the header line of each screen. The following buttons are also displayed in the header line (from left to right):

- History: Call a list with the most recently changed settings by the individual users.
- User: Call the user administration (see section 6.8 "User administration").
- Service: Call the service page for the Rittal service personnel (see section 6.9 "Service").
- Configuration: Call the configuration pages (see section 6.10 "Configuration").
- Online help: Display of the available instructions.
- Information: Call the version information of the Secarex software.
- Logout: Log out the user currently logged in.

An appropriate symbol centred in the header line, at the right of the machine name, indicates whether (green symbol) or not (red symbol) a connection is currently established to the control unit in the enclosure (PLC).

Various tabs are displayed under the header line. Related information within an area is also grouped on these tabs.

The actual information is grouped in the main area of the screen. For example, projects can be selected for machining and workpieces can be deleted from the production list.

Buttons for performing the actions on the current screens are located at the lower screen edge.

## 6.2.4 Login and logout

The following screen is displayed after starting the Secarex AC 18 as well as after logging out from the Secarex software. If this screen page appears, automatic login is not activated for any user (see section 6.8 "User administration").

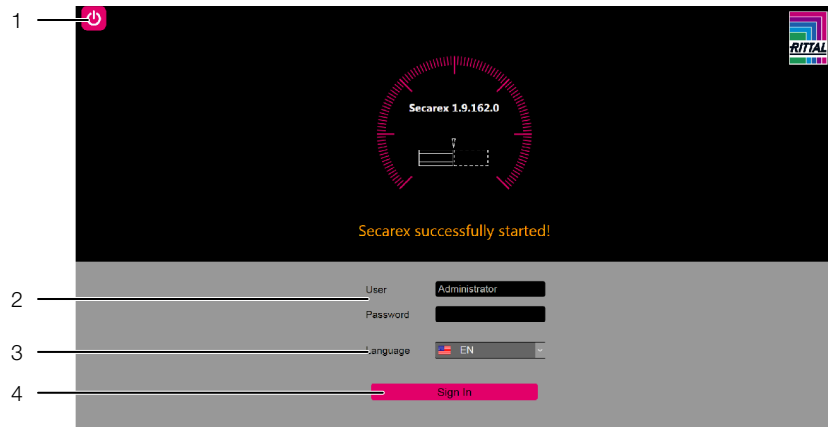

Fig. 7: Login and logout

**Key**

- 1 "Off" button
- 2 Input fields for user name and password
- 3 Switch language for the Secarex software
- 4 "Login" button



**Note:**

You will be informed during the machine commissioning of the currently valid user for the administration (see section 6.8 "User administration").

- Enter the name of the desired user and the associated password in the appropriate fields.
- Select the desired language for the Secarex software.
- Press the "Login" button to start the actual Secarex software.  
The Secarex software is started and the "Production" area displayed.
- Alternatively, press the "Off" button at the top left on the screen to end the Secarex software.

This screen is also displayed after logout from the Secarex software. The "Password" field, however, is empty.

## 6.3 Production

### 6.3.1 General information



**Note:**

The "Production" area is displayed automatically as start page after the login. If a different area is selected in the Secarex software, such as "Configuration", pressing the "Production" button returns to the "Production" area.

The actual machining is prepared and started in the "Production" area. To do this, a connection is normally established to EPLAN ProPanel or the database of the "Workshop programming" program in which the projects to be machined on the Secarex AC 18 have been created previously (see section 6.10.3 "Software"). If no connection to this database exists, alternatively, a production list can also be created externally and imported into the Secarex software (see section 6.4 "Working with CSV files").

The sequence for machining in semiautomatic operation is divided into the following sections:

- Create a production list with the workpieces to be machined
- Group the raw parts based on the bill of materials

– Actual machining of the workpieces

### 6.3.2 Creating a production list

The production list for a machining operation is created on the "Preparation" tab in the "Production" area. Generally, new projects are created in the "Workshop programming" program. Alternatively, a production list can also, for example, be created in EPLAN ProPanel using a PPR file (see section 6.6 "PPR import") or from an imported CSV file (see section 6.4 "Working with CSV files"). If a connection exists to the database of the "Workshop programming" program, all projects that can be machined on the Secarex AC 18 are displayed in the left-hand sub-area of this tab.



**Note:**

Before preparing a production list, when the above-mentioned database is used, it must first be updated by pressing the "Update" button (fig. 6, item 4). Only then are all projects of the current data pool displayed in the Secarex software.

### Deleting the complete production list

■ If necessary, first press the "New" button if workpieces are displayed already in the right-hand "Production list" area of the screen.

The complete production list is deleted and you can start a new project.

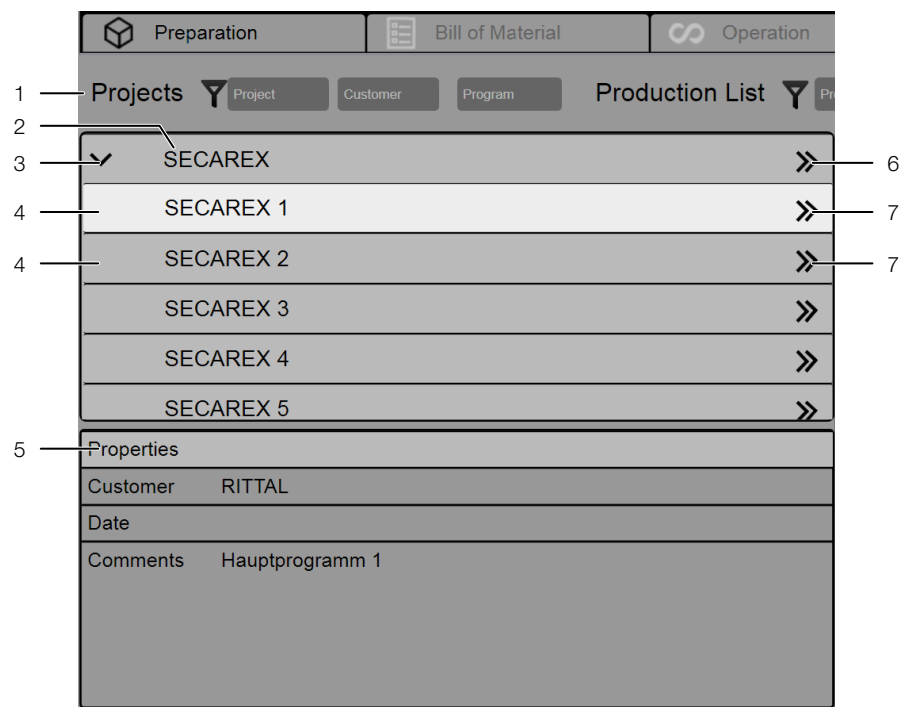

Fig. 8: "Preparation" tab – Projects

**Key**

- 1 Filter fields for the displayed projects
- 2 Name of the associated project
- 3 Button for displaying the main programs
- 4 Main programs of the selected project
- 5 Properties of the selected project or main program
- 6 Transfer the complete project to the production list
- 7 Transfer the associated main program to the production list

### Filtering the project list

If the list of the displayed projects is very long, filter fields can be used to restrict the list of the displayed projects.

The following filter criteria are available:

- Project name
- Customer name
- Program name
- Click the field with which you want to restrict the list of displayed projects (e.g. "Projects").
- Begin on the keyboard with the input of the desired term.  
The list of the displayed projects changes in accordance with the entered search term.



Note:

The filter fields do **not** differentiate between uppercase and lowercase. This means, the "SECAREX" project is also found when you enter "Se" in the associated filter field.

### Deleting projects from the project list

Projects can be deleted from the project list. After the deletion, the workpieces of the project are retained. For imported projects, e.g. from a PPR file or a CSV file, the project is deleted only from the project list; the associated file remains on the data medium.

- Right-click the project that you want to delete from the project list.  
A context menu with the "Delete" entry opens.
- Left-click this entry to delete the project directly from the project list.  
**No** prompt appears whether the project should actually be deleted.
- Alternatively, click another project in the project list if you want delete a different project.  
The context menu closes.

When a project has been deleted from the project list that is stored in the database of the workshop programming, the project is displayed again in the project list when the "Refresh" button is pressed.

### Transferring a project to the production list

You can now transfer the workpieces of the complete project (including **all** main programs) to the production list.

- Press the ">>" button (fig. 8. item 6) behind the project name.  
A window opens in which the quantity for the production list can be specified.  
The specified quantity applies equally to all workpieces stored in the production list.

**Example:** If 14 workpieces are stored in the production list and you enter the value 2, all workpieces are imported duplicated. This means a total of 28 workpieces are added to the production list.

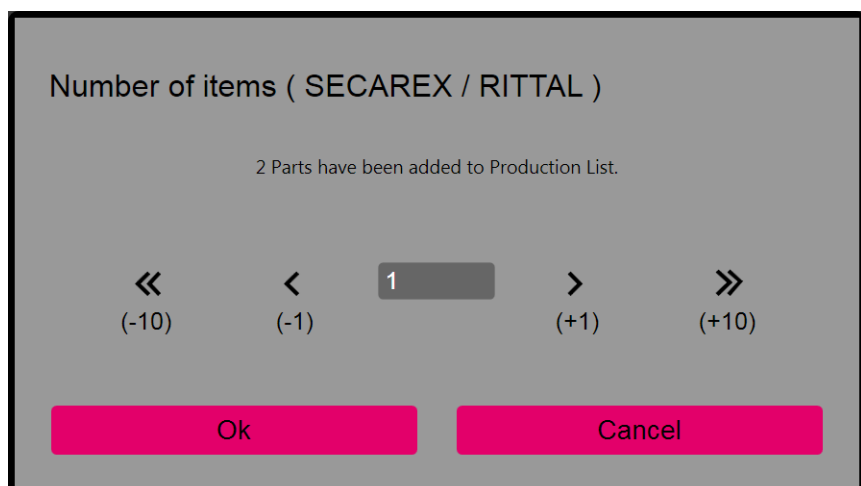

Fig. 9: Quantity of workpieces



Note:

If no data for machining with the Secarex is contained in a project, this project is empty.

---

### Transferring a main program to the production list

Alternatively, you can also transfer only the workpieces of individual main programs to the production list.

- Press the ">" button (fig. 8. item 3) in front of the project name.  
The list of main programs contained in the project is displayed.
- Press the ">>" button (fig. 8. item 7) behind the name of the desired main program.

All workpieces from this main program are transferred to the production list. A request of the quantity is also made here initially.

---



Note:

Pressing a ">>" button (fig. 8. item 7) returns the workpieces to the production list. You can also group the workpieces of several main programs in a production list.

---

The following information for the individual workpieces is displayed in the production list:

- Project name
- Program name
- Workpiece name
- ID of the workpiece within the main program
- Set length of the workpiece after the machining
- "<>" button to perform a single production
- Workpiece status (e.g. "Being machined" or "Miscut") as symbols



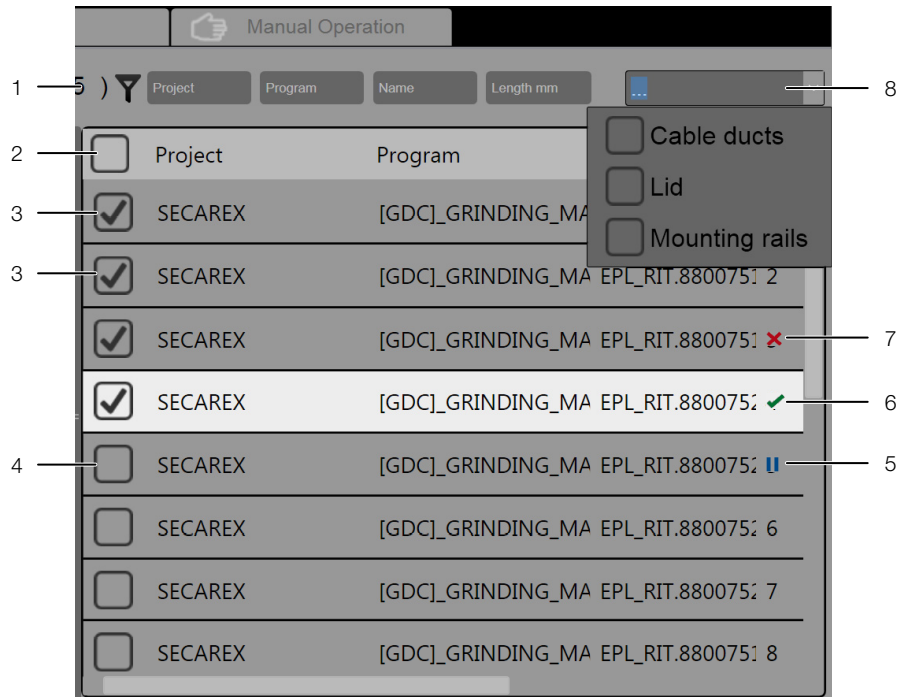

Fig. 10: "Preparation" tab – Production list

**Key**

- 1 Filter fields for the displayed production list
- 2 Header line with checkbox for selection and deselection of all workpieces
- 3 Selected workpiece
- 4 Non-selected workpiece
- 5 "Being machined" status
- 6 "Miscut" status
- 7 "Machining completed" status
- 8 "< >" button
- 9 Filter for the workpiece type (cover, duct, rail)

**Filtering the production list**

If the list of the displayed workpieces is very long, like the project list, filter fields can be used to restrict this list.

The following filter criteria are available:

- Project name
- Program name
- Workpiece name
- Workpiece length
- Workpiece type (cover, duct, rail)

- In the Filter field, select the workpiece types that should be displayed in the production list.
- Click the field with which you want to further restrict the list of displayed workpieces (e.g. "Program name").
- Begin on the keyboard with the input of the desired term.  
The list of the displayed workpieces changes in accordance with the entered search term.

**Note:**

The filter fields do **not** differentiate between uppercase and lowercase. This means, the "SECAREX 1" program is also found when you enter "Se" in the associated filter field.

The filter fields in the production list allow the number of displayed workpieces to be reduced accordingly. This does not affect the actual machining.



**Note:**

Before starting the machining, ensure that no filters are used in the production list so that all workpieces to be machined are displayed in the production list.

### Deleting individual workpieces from the production list

Finally, you can remove individual workpieces from the production list.

- Select successively the desired components by activating the checkbox (fig. 10, item 3) in front of the associated component.
- Press the "Delete" button (fig. 6, item 4) to delete the marked components from the production list.

If you want to delete very many workpieces and leave only a few in the production list, proceed as follows:

- Activate the checkbox in the header line of the production list to (initially) select all workpieces.
- Reactivate the checkbox of those workpieces that should **not** be deleted from the production list.  
The marking will be removed.
- Press the "Delete" button again to delete the marked components from the production list.

### Performing individual machining

You can directly machine individual workpieces. However, no waste optimisation is performed for individual machining.

- Press the "<>" button (fig. 10, item 8) in the "EF" column of the workpiece that you want to machine.

The "Operation" tab is displayed for performing the actual machining (see section 6.3.4 "Machining (operation)").



**Note:**

After completion of the single production, the "Preparation" tab can be selected to return to the production list.

### 6.3.3 Viewing the bill of materials

The Secarex software can create a bill of materials for the workpieces listed in the production list. As part of the waste optimisation, identical raw parts are grouped, irrespective of the main program or project in which they are used. This bill of materials is displayed on the "Bill of materials" tab in the "Production" area.

	Item Number	Quantity	Type	Comments
1	4261267	3	Kanal	Kabelkanal 100 mm x 100 mm
2	@4261267	2	Deckel	Kabelkanal 100 mm x 100 mm
	1982341	1	Hutschiene	Hutschiene 35 mm x 7,5 mm mit Gewinde M5

Fig. 11: "Bill of materials" tab

**Key**

- 1 Model number of the wiring duct
- 2 Associated cable duct cover (with prefixed "@")

For wiring ducts and support rails, the model number as stored for the associated workpiece is displayed in the first column. For cable duct covers, an "@" is prefixed to the model number of the associated wiring duct.



**Note:**

No adapting cuts (first cut or intermediate cuts) are required for cable duct covers because no hole pattern needs to be considered. For this reason, it is possible that a different number of wiring ducts and the associated cable duct covers is required.

- Provide near the Secarex AC 18 all raw parts required for the machining based on the bill of materials.  
This allows you to machine the complete production list within a short time.

### 6.3.4 Machining (operation)

Select the "Operation" tab (fig. 12, item 3) to start the actual machining. The operating steps to be performed by the operating personnel are displayed on the screen.



**Note:**

The machining of a wiring duct is now described as example. The operating steps to be performed are displayed on the screen in plain language.



**Caution!**

**Danger of jamming at the automatic length stop!**  
To prevent a possible jamming, remove any workpieces from the support before traversing the stop.

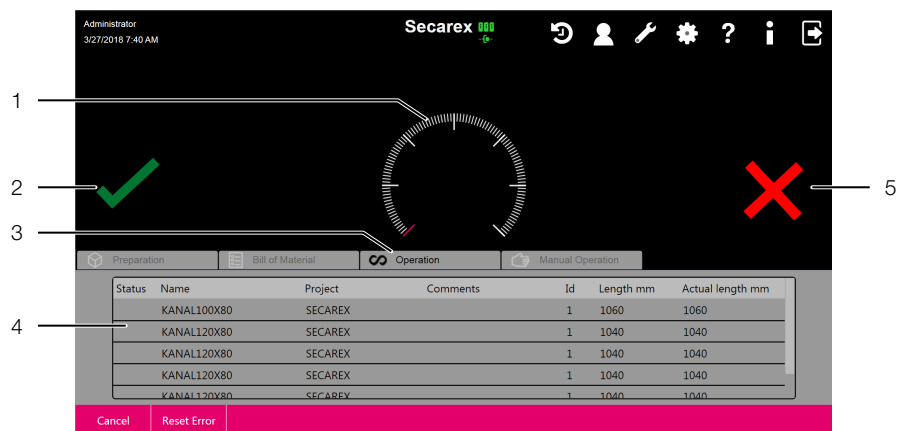

Fig. 12: "Operation" tab

**Key**

- 1 Progress display
- 2 "Continue" button
- 3 "Operation" tab
- 4 Production list
- 5 "Workpiece defect" identifier

### Starting the machining

- Select the "Operation" tab to perform the actual machining.

### Performing the first cut

The machining data for the first workpiece is displayed on the operating panel. The "Waiting for confirmation of the machining data with Start" message is displayed.

- First check the data for the first workpiece.

## 6 Working with the machine

EN

- Ensure that the replaceable fastener for the wiring ducts and cable duct covers is inserted in the correct alignment. If necessary, lift the fastener and replace it turned through 180° for ducts deeper than 100 mm, so that the separation of the fixing to the rear limit stop becomes larger (fig. 2).



Fig. 13: Alignment of a cable duct

### Key

- 1 Viewing window
- 2 Interface on the cable duct
- 3 Counter blade
- 4 Fastener for wiring ducts and cable duct covers

- Press the "Start" key (fig. 3, item 4) on the operating console when you want to machine the first workpiece from the displayed production list. The "Insert a new cable duct, perform first cut with TWO-HAND OPERATION" message is displayed.

To correctly align the wiring duct, the operator can look through the viewing window in the hood. The interface is located parallel to the position of the counter blade.

- Feed the workpiece specified in the display to the cutting area from the left-hand side.
- Align the workpiece so that
  - the cutting edge is aligned correctly in accordance with the hole pattern,
  - the cut is made between two teeth of the wiring duct.



### Note:

For the first cut, the workpiece must **not** be present at the automatic length stop.

- Press and hold down the two "Two-hand duct" keys simultaneously (fig. 3, item 1) left and right on the operating console. Directly before cutting, the automatic length stop is raised slightly from the workpiece. The first cut on the workpiece is performed. The "Remove workpiece, position with Start" message is displayed.

### Creating the first workpiece in accordance with the production list

- Remove the workpiece separated by the first cut.
- Press the "Start" key (fig. 3, item 4), the automatic length stop travels to the required length of the workpiece.

The "Insert cable duct, cut with TWO-HAND OPERATION" message is displayed.



**Note:**

The teeth separation of the wiring duct normally causes a (small) deviation between the required set length of the workpiece and the actual length.

- Move the wiring duct from the left to the automatic length stop and place the workpiece at the rear limit stop (fig. 2).
- Look from the front through the viewing window in the hood to ensure that the wiring duct is aligned correctly and the cut is always made between two teeth.



**Caution!**

**Risk of injury caused by flying fragments!**

**If the blade meets the teeth of the wiring duct, there is a risk of injury to the operator caused by flying fragments. There is also a risk of damage to the blade and the complete machine.**

- If necessary, correct the position of the wiring duct by (slightly) retracting back from the automatic length stop.
- Press and hold down the two "Two-hand duct" keys simultaneously (fig. 3, item 1) left and right on the operating console.  
The cut is performed. If the label printer is activated, an appropriate label will be printed with all required information (see section 6.10.3 "Software" (Label printing)).  
The "Remove workpiece, position to the intermediate cut with Start" message is displayed.
- Remove the workpiece and attach the label.

**Performing the intermediate cut**

- Press the "Start" key (fig. 3, item 4).  
The automatic length stop travels to the calculated value with which the desired alignment of the cut edge is established to the hole pattern.  
The "Insert cable duct, cut with TWO-HAND OPERATION" message is displayed.
- Look from the front through the viewing window in the hood to ensure that the wiring duct is aligned correctly and the cut is always made between two teeth.



**Caution!**

**Risk of injury caused by flying fragments!**

**If the blade meets the teeth of the wiring duct, there is a risk of injury to the operator caused by flying fragments. There is also a risk of damage to the blade and the complete machine.**

- If necessary, correct the position of the wiring duct by (slightly) retracting back from the length stop.
- Press and hold down the two "Two-hand duct" keys simultaneously (fig. 3, item 1) left and right on the operating console.  
The intermediate cut is performed and the "Waiting for confirmation of the machining data with Start" message is displayed.

### Further machining of workpieces

Hereafter, the instructions and operating steps are repeated until the complete production list has been processed. The progress of the complete machining is displayed above the production list.

If the remainder does not suffice for the following machining of a workpiece, the operator will be requested to perform a material replacement. In this case, a first cut is required initially again. The Secarex software issues an appropriate message.



**Note:**

With a switch to the "Preparation" tab, the operator can at anytime see the machining progress based on the production list. Previously machined workpieces are marked.

### Deviations for cable duct covers and support rails

The machining of cable duct covers and support rails involves the following deviations from the above-mentioned processing sequence.

- **Cable duct covers:** No adapting cuts (first cut or intermediate cuts) are required for cable duct covers because no hole pattern needs to be considered.
- **Support rails:** Due to the templates and the encapsulation of the tool, there is no risk of the operator being cut when shortening support rails. Consequently, the cutting operation for support rails is **not** initiated with the two "two-hand duct" keys, but rather with the "Cut rail" key (fig. 3, item 2) (one-hand operation). If necessary, the complete mounting station can be replaced as appropriate for the type of the support rails to be machined (see section 7.6.2 "Track tool").

### Aligning a support rail for the first cut

The encapsulation of the track tool means no viewing window can be used to check the cutting point on the workpiece. Proceed as follows to correctly align the support rails for the first cut:

- Place the support rail on the label so it points exactly to a possible separation point, appropriate for the hole pattern (normally centred between two elongated holes, fig. 14).

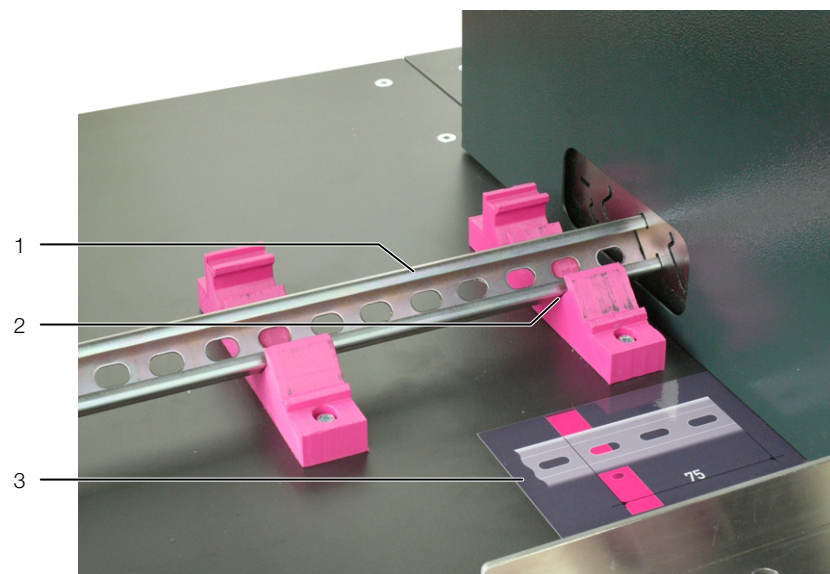

Fig. 14: Placing a support rail on the support

**Key**

- 1 Support rail
- 2 Contact point
- 3 Label in front of the support

## Marking a workpiece as defect

If a workpiece has not been machined correctly (miscut), it can be marked once as "defect".

- Press the "Workpiece defect" button on the screen (fig. 12, item 5).  
The currently selected workpiece is marked accordingly in the production list.



Note:

A first cut or an intermediate cut cannot be marked as defect.

## 6.3.5 Cancelling and resuming a machining operation

A machining operation can be cancelled at anytime. The calculated data for the waste optimisation, however, is lost.

- Press the "Cancel" button.  
The following message window is displayed.

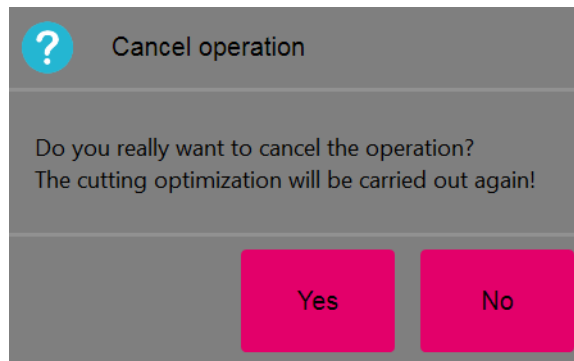

Fig. 15: "Cancel operation" window

- Confirm the prompt with "Yes" if you want to cancel the machining.
- Alternatively, press the "No" button to exit the "Cancel operation" screen.

## Resuming the machining

To resume the project, we recommend the following procedure:

- Switch to the "Preparation" tab (see section 6.3.2 "Creating a production list").
- Delete the previously machined workpieces from the production list.  
You can recognise such workpieces by the marking in the "Status" column.
- As alternative, you can create a complete production list for this project.
- Group (again) the required workpieces based on the details on the "Bill of materials" tab.
- Start the machining of the remaining workpieces on the "Operation" tab.

## Cancelling the machining in an emergency situation

In the event of an emergency situation, the program sequence and the machining can be stopped immediately by pressing the EMERGENCY STOP key on the operating console (fig. 3).

- Press the EMERGENCY STOP key on the operating console.  
The program is cancelled and all movements are stopped immediately.

## Restoring operability

After pressing the EMERGENCY STOP key (fig. 3, item 3), operability can be restored as follows.

- Pull out the EMERGENCY STOP key.
- Press the "Control voltage On" key on the upper operator panel to confirm the emergency off message and to restore the control power.
- Press the "Reset Error" button (fig. 12) on the operating panel to confirm all pending error messages.

## 6.3.6 Manual operation

In manual operation, workpieces can be shortened without waste optimisation for a specified value.

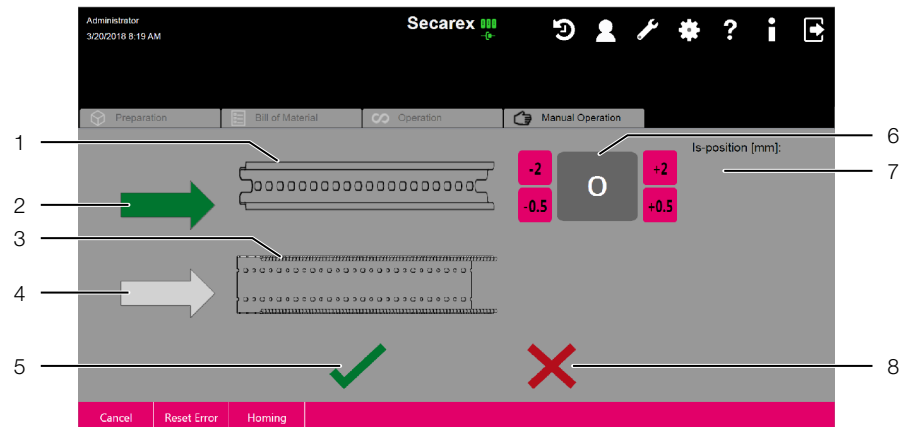

Fig. 16: "Manual operation" tab

### Key

- 1 Stylised support rail
- 2 "Arrow" button for track tool (activated here)
- 3 Stylised wiring duct
- 4 "Arrow" button for duct tool
- 5 "Continue" button
- 6 "Set Length" button for track tool (activated here)
- 7 "Actual position of the automatic length stop" display for track tool
- 8 "Cancel" button

- Select the "Manual operation" tab.
- Press the "Arrow" button in front of the stylised workpiece to select the track tool or duct tool.  
The arrow is shown green, and the input field for the set length of the workpiece as well as the display of the actual position of the automatic length stop are displayed behind the workpiece.
- Enter the desired length of the workpiece in the "Set length" input field for the previously selected tool.
- Press the "Continue" button to confirm your input.  
The automatic length stop travels to the required position.
- Press the two "Two-hand duct" keys if you have preselected the cutting of a wiring duct or a cable duct cover, or alternatively the "Cut rail" key (fig. 3. item 2) if you have preselected the cutting of a support rail.

## 6.4 Working with CSV files

### 6.4.1 General information

If the "Workshop programming" program is not available, you cannot establish any connection to a database that contains the orders (see section 6.10.3 "Software"). In this case, it is possible to create a production list as a CSV file.



#### Note:

The CSV file should be saved with "UTF-8" coding. This allows accented characters to be displayed correctly in the Secarex software.

### 6.4.2 Structure of the CSV file

This type of production list is a simple text file that contains the following information items each separated by commas:

- **Name:** Workpiece name (mandatory).



- **AbstandZaehne**: Separation of the teeth for wiring ducts. The value is used for the waste optimisation (mandatory).
- **ArticleId**: Model number. The value is displayed in the bill of materials (mandatory).
- **ProgrammId**: Number of the program. The value is displayed in the "ID" column in the production list (optional).
- **ArticleType**: Workpiece type. One of the values "duct", "top-hat rail", "CProfile" or "cover" must be present (mandatory).
- **Length**: Set length of the workpiece (mandatory).
- **Kommentar**: Any comment (optional).
- **MinEndAbstand**: The minimum distance of the last hole to the end of the workpiece. The value is used for the waste optimisation (mandatory).
- **PosX**: The distance of the first hole to the start of the workpiece. The value is used for the waste optimisation (mandatory).
- **ProgramName**: Name of the main program. The value displayed in the "Program" column in the production list (optional).
- **ProjectName**: Name of the associated project. The value is displayed in the "Project" column in the production list (optional).
- **Raster**: Distance between the holes. The value is used for the waste optimisation (mandatory).
- **RohteilLaenge**: The length of the raw part. The value is used for the waste optimisation (mandatory).
- **Breite**: The width of the workpiece to be produced.
- **Anzahl**: The number of workpieces to be produced.

The above-mentioned identifiers shown bold must be added to the first line of the CSV file. The data for the individual workpieces is listed in the following lines. Such a complete file is shown below.

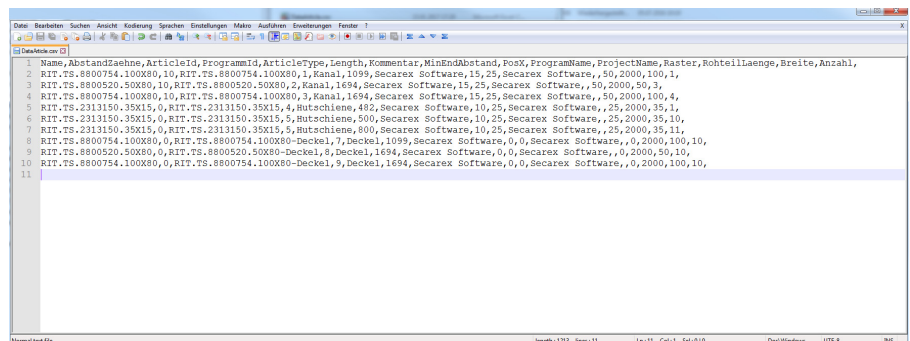

Fig. 17: CSV file in a text editor

Alternatively, you can request an Excel file from Rittal in which you can enter the required data. This file includes a macro with which you can create the CSV file automatically.

### 6.4.3 Importing a CSV file

The production list must be imported into the Secarex software.

- Press the "Import" button on the "Preparation" tab.

A dialogue for selecting a CSV file opens.

- Ensure that only CSV files are displayed in the file filter ("CSV (\*.csv)" selection).
- Select the desired file and press the "Open" button to confirm your selection.

Similar to adding a project to the production list, a window opens in which the associated quantity can be specified. The specified quantity applies equally to all workpieces stored in the production list.

If the data could not be imported, the appropriate "Import failed" message with a possible fault cause is displayed.

## 6.5 Importing a text file

### 6.5.1 General

In addition to importing a CSV file (see section 6.4 "Working with CSV files") a production list can also be specified as a text file. Whereby, a connection to a database in which the components are stored must be available.



Note:

The text file should be saved with "UTF-8" coding. This allows accented characters to be displayed correctly in the Secarex software.

### 6.5.2 Structure of the text file

This type of production list is a simple text file that contains the following information items, each separated by vertical bars:

- **Order:** Name of the order. The value is displayed in the "Project" column in the production list.
- **ID:** Number of the program. The value is displayed in the "Comment" column in the production list.
- **Article:** Designation of the workpiece. The value is displayed in the "Program" column in the production list. The workpiece must be stored with this designation (model number) in the database of the workshop programming.
- **Length:** Set length of the workpiece. The entry is specified in mm with a decimal point.
- **Workpiece:** Workpiece type. This serves only for identification in the text file. The actual type of the workpiece is taken from the database.



Note:

Entries that do not consist just of numbers must be enclosed within "straight" quotes ("").

The above-mentioned identifiers shown bold are **not** used in the text file.

**Example:** "K2016-084\_1"|U2|"LVK7331 / 40x80"|894.0|"KK"



Note:

The wiring ducts or support rails to be imported must be created in the workshop programming with the appropriate model number ("Article" column) as variable components so that missing details can be augmented appropriately.

### 6.5.3 Importing a text file

In general, a text file is imported in the same manner as a CSV file (see section 6.4.3 "Importing a CSV file").

- However, press the "Import" button on the "Preparation" tab.
- Ensure that only TXT files are displayed in the file filter ("Import text files (\*.txt)" selection).

## 6.6 PPR import

### 6.6.1 General

The so-called PPR import is also possible. The PPR file (with further files) can be created via the ASCII interface of "EPLAN ProPanel" or the workshop programming. The following files are required for the export:

- **PPR file:** Main program.
- **PVB file:** Definition of the variable components.

Because these files are created automatically, no detailed description of the file structures is provided.

### 6.6.2 Importing a PPR file

In general, a PPR file is imported in the same manner as a CSV file (see section 6.4.3 "Importing a CSV file").

- However, press the "Import PPR" button on the "Preparation" tab.
- Ensure that only PPR files are displayed in the file filter ("PPR (\*.ppr)" selection). In addition to the PPR file, a PVB file with the same name must be present in the same directory. This file contains the definitions of the deployed variable components.

## 6.7 History

### 6.7.1 General

A list with the settings most recently changed by the individual users is displayed on the "History" screen.

- Press the "History" button (fig. 18, item 1) in the header line of the Secarex software.

The "History" screen opens.

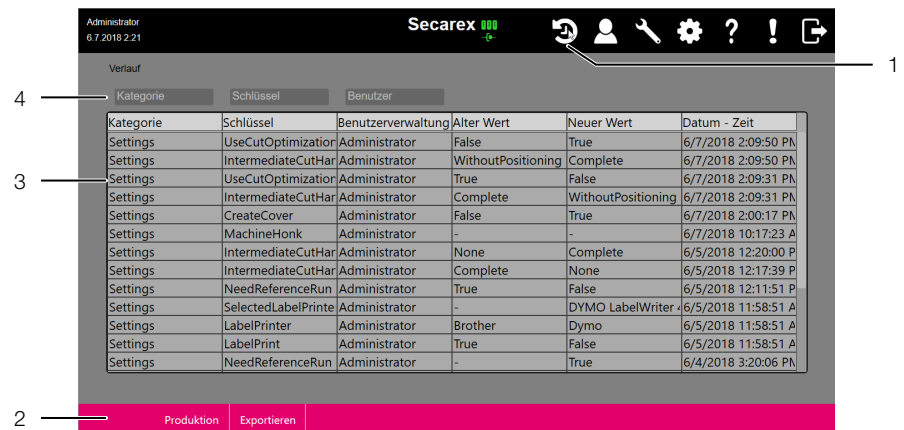

Fig. 18: "History" screen

#### Key

- 1 "History" button
- 2 Buttons
- 3 Entries with changed settings
- 4 Filter fields for the displayed entries

### 6.7.2 Filtering the entries

If the list of the displayed entries is very long, filter fields can be used to restrict the list of the displayed entries.

The following filter criteria are available:

- Category
- Key
- User
- Click the field with which you want to restrict the list of displayed entries (e.g. "Users").
- Begin on the keyboard with the input of the desired term.

The list of the displayed entries changes in accordance with the entered search term.

### 6.7.3 Exporting the history

The complete list can be exported as a CSV file so it can be browsed and evaluated with a spreadsheet program (e.g. Excel) on a separate PC.

- Press the "Export" button (fig. 18, item 2).

A dialogue opens in which you select a directory and enter the name for the CSV file to be exported.

- Press the "Save" button to confirm your inputs.

The CSV file is saved appropriately and the dialogue closes.

- Alternatively, press the "Cancel" button to exit the dialogue.  
No CSV file is saved.

## 6.8 User administration

Various users with different names, roles and passwords can be created on the "User administration" screen.



Note:

To access the user administration, the currently logged-in user must have been assigned the "Administrator" or "Service" user role.

- Press the "User" button.  
The following screen is displayed.

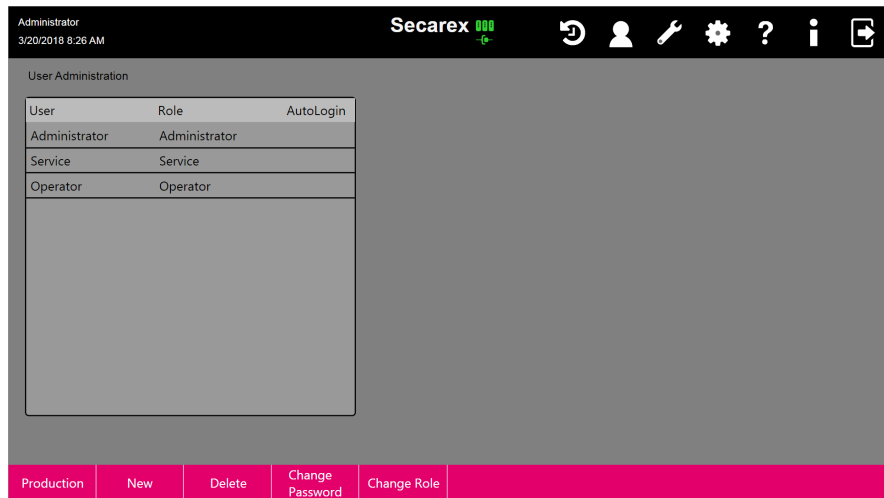

Fig. 19: "User administration" screen

All currently created users with their associated user role are displayed. You can also specify here which user with the "Operator" role is logged in automatically. In this case, after starting the Secarex software, the login screen does not appear, but rather the "Production" area directly.

- Activate the symbol in the "Autologin" column for the desired user.  
The symbol is greyed-out when the automatic login is deactivated. The symbol is shown black when the automatic login is activated.

### 6.8.1 Creating a user

- Press the "New" button on the "User administration" screen.  
The following screen is displayed.

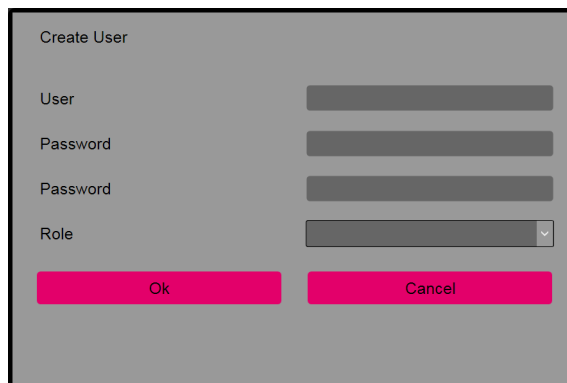

Fig. 20: "Create user" screen

- Complete all fields shown here.
  - **User:** The name of the user who then logs in to the Secarex software.

- **Password:** The password that the user must enter for the login. Other than the Password field must not be empty. No further restrictions are placed on the password. The password must be repeated in the second Password field.
- **Role:** Three user roles are possible: Administrator, Service and Operator. Users with the Operator user role do not have any access to the "User administration" and "Service" screens.
  - Press the "OK" button to confirm your inputs.
    - The "User administration" screen opens again; the newly-created user is displayed accordingly in the list.
  - Alternatively, press the "Cancel" button to exit the "Create user" screen.
    - The inputs are then discarded and no new user is created.

### 6.8.2 Deleting a user

- On the "User administration" screen, select the user to be deleted.
- Press the "Delete" button.
  - The following screen opens.

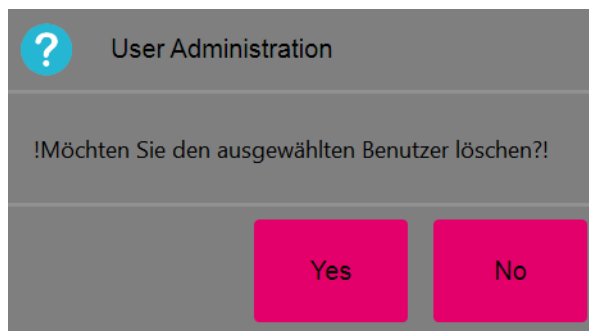

Fig. 21: The "Delete user" prompt

- Press the "Yes" button to confirm your inputs if you want to delete the selected user.
  - The user is deleted and the "User administration" screen opens again.
- Alternatively, press the "No" button to exit the "Create user" screen.
  - In this case, the user is not deleted and the "User administration" screen also opens.

### 6.8.3 Changing the password

- Select on the "User administration" screen the user name whose associated password should be changed.
- Press the "Change Password" button.
  - The following screen is displayed.

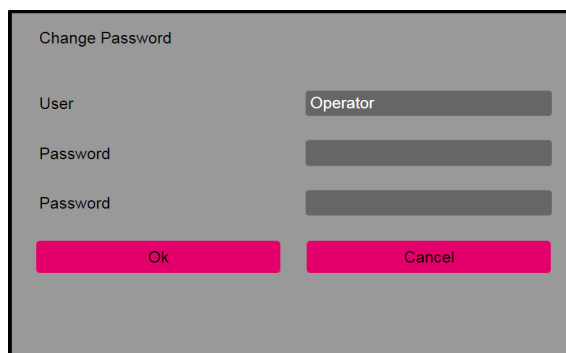

Fig. 22: "Change password" screen

- Enter the new password in the "Password" field.
- Re-enter the password in the second password field.
- Press the "OK" button to confirm your inputs.
  - The "User administration" screen opens again. The password of the user has been changed accordingly.

- Alternatively, press the "Cancel" button to exit the "Create user" screen. In this case, the current password of the user is retained.

### 6.8.4 Changing the user role

- Select on the "User administration" screen the user name whose user role should be changed.
- Press the "Change Role" button. The following screen is displayed.

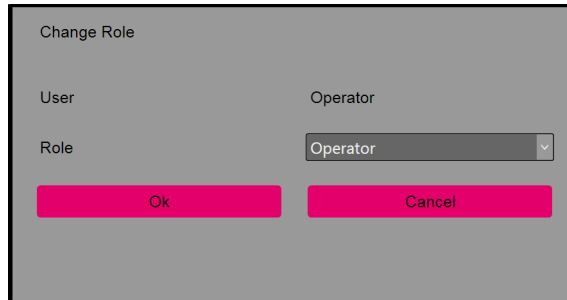

Fig. 23: "Change role" screen

- Select in the list the new user role for the selected user.
- Press the "OK" button to confirm your inputs. The "User administration" screen opens again. The changed user role is displayed accordingly in the list.
- Alternatively, press the "Cancel" button to exit the "Create user" screen. In this case, the current user role of the user is retained.

### 6.9 Service

The basic settings of the machine are displayed on the "Service" screen. Only Rittal service personnel and the administrator can make changes to these values.

- Press the "Service" button.

An information window with the version number of the installed software version is also displayed on this screen.

- Press the "Info" button.
- Have this information available when support is requested from the Rittal Service.

### 6.10 Configuration

#### 6.10.1 General information

Advanced settings for the Secarex software can be performed on the tabs in the "Configuration" screen. These are normally one-off settings made after commissioning the machine.

- Always save all changes made on the "Configuration" screen by pressing the "Save" button. Only then are your changes saved permanently in the Secarex software.

#### 6.10.2 Machine

Various basic settings for the Secarex can be made on the "Machine" tab.

## Machine Number

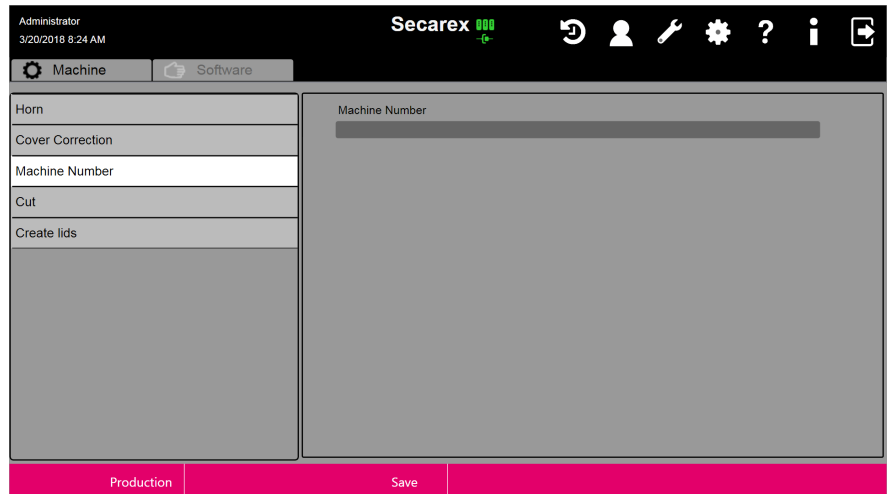

Fig. 24: "Machine" tab – "Machine Number" settings

- If required, enter an arbitrary, unique machine number or a machine name for the unique machine identification.

This entry appears on the login screen (fig. 7) below the version number of the Secarex software.

## Cover Correction

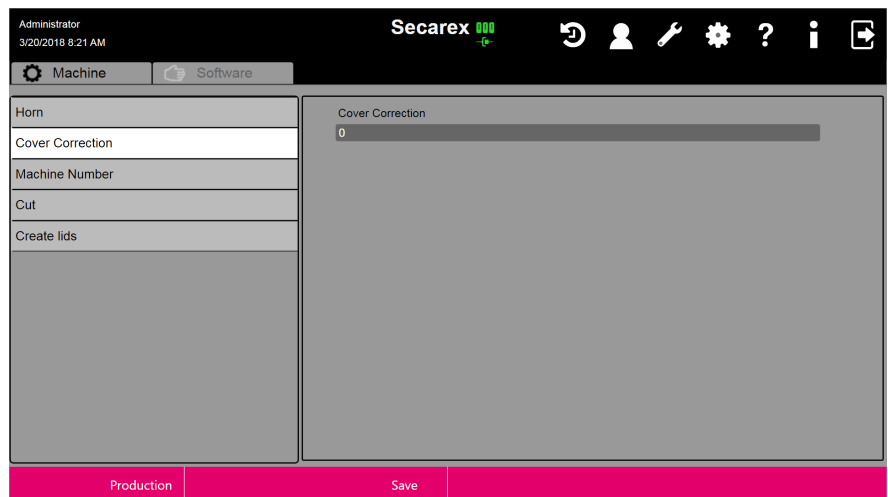

Fig. 25: "Machine" tab – "Cover Correction" settings

The cover correction allows the cover for the wiring ducts always to be cut longer by a specific amount.

- Enter in the "Cover correction" field, the desired dimension in millimetres by which a cover should be cut longer than the associated wiring duct. Whereby, this is a global specification for **all** covers.

## Cut

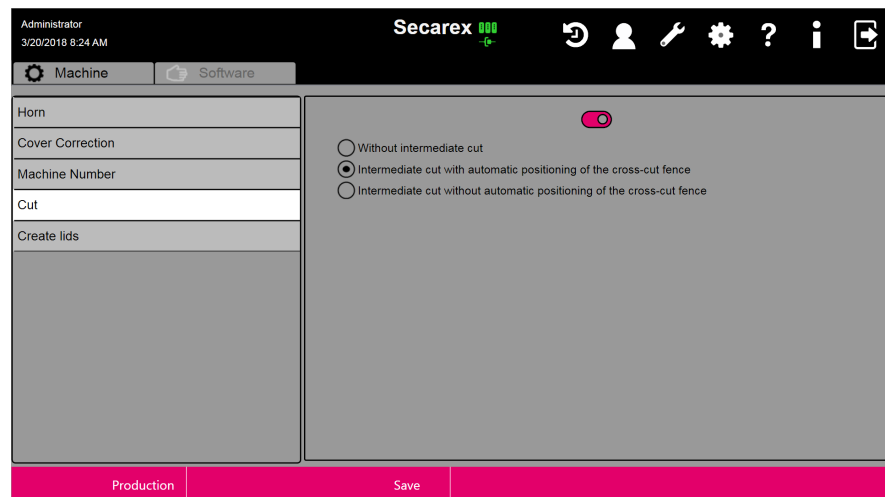

Fig. 26: "Machine" tab – "Cut" settings

The waste optimisation can be activated and deactivated in the upper area of the screen.

- After activation of the waste optimisation, select whether an intermediate cut should be performed; if yes, whether or not the limit stop should be positioned automatically.

- Ensure that the label printer is activated in the user interface when you activate waste optimisation (see section 6.10.3 "Software").

If this is not done, you can no longer correctly assign the individual workpieces to the projects, because the waste optimisation assigns the production items in a different sequence than which they are imported.

## Create lids



Fig. 27: "Machine" tab – "Create lids" settings

You can specify whether an entry for the associated cover with the appropriate length is created for a wiring duct ("activated" setting).



**Note:**

This setting acts only when the data from the database of the workshop programming is imported (not when a CSV or PPR file is imported).



## Homing

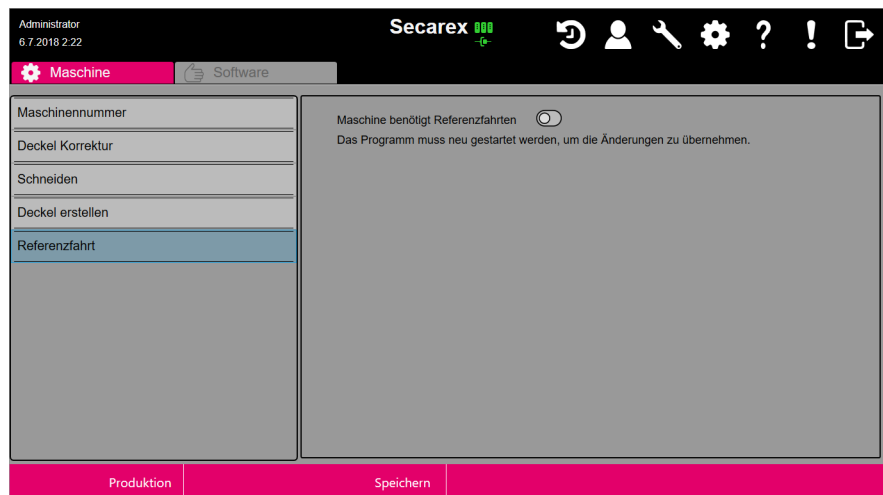

Fig. 28: "Machine" tab – "Homing" setting

You can specify whether or not the machine performs homing.



### Note:

Because the Secarex AC 18 machine does not require homing, this setting is deactivated for this machine.

### 6.10.3 Software

The settings for connecting the Secarex software to the workshop programming database as well as the settings for the label printer are made on the "Software" tab.

## Database

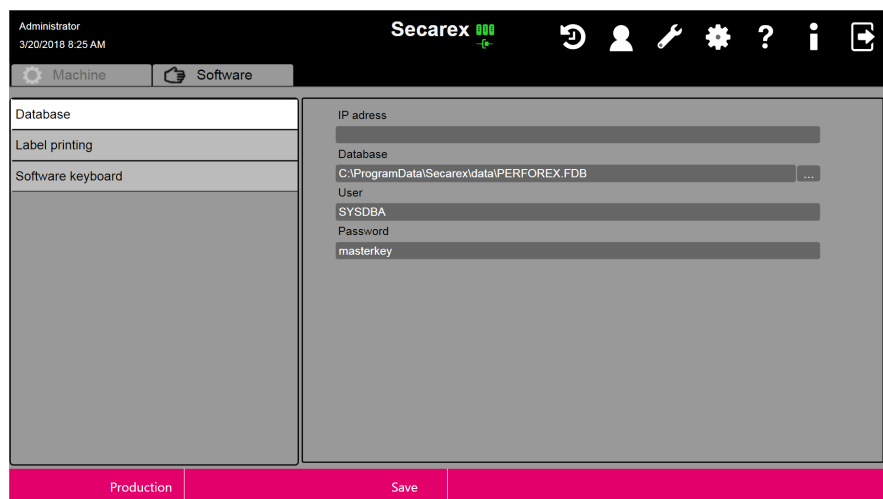

Fig. 29: "Software" tab – "Database" settings

- If you use the workshop programming database, enter the path for the database as well as the user and the associated password.
- If the database is not stored directly on the Secarex machine, but rather on a database server in the network, enter here the IP address or the host name of this computer. Note that in this case, the drive letter in the path to the database from the viewpoint of the computer on which the database server runs, and not a network drive, is entered.
- Press the "Save" button.

The connection to the database is then tested automatically. If no connection can be established using the data specified on the screen, an appropriate message will be issued.

## Label printing

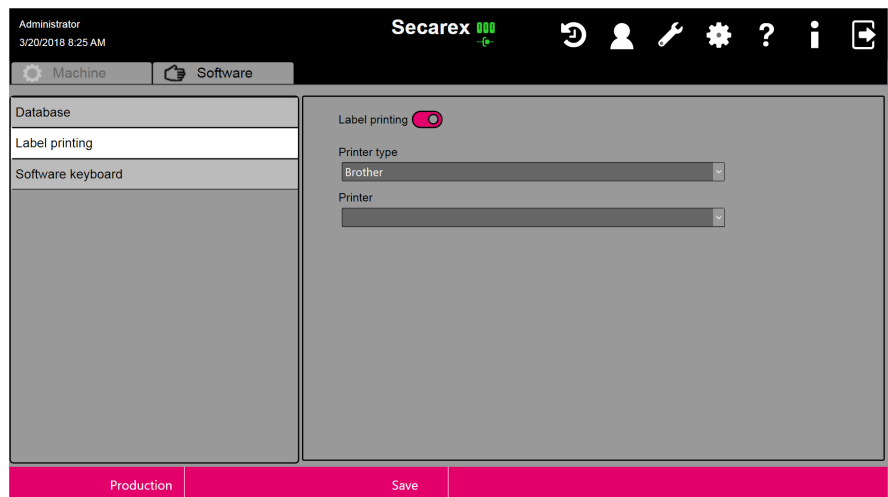

Fig. 30: "Software" tab – "Label printing" settings

- Enable or disable the label printer.
- Also select the manufacturer and the exact name of the printer with which it is registered in the operating system.

## Software keyboard

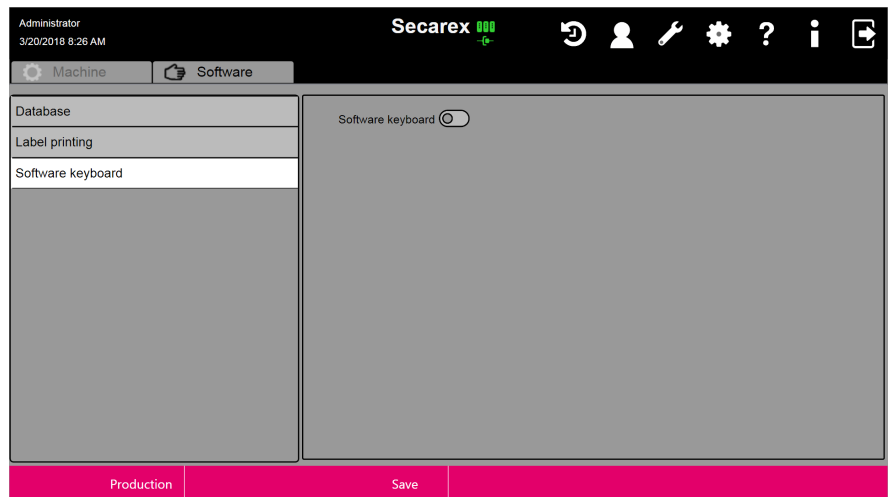

Fig. 31: "Software" tab – "Software keyboard" settings

- Activate or deactivate the software keyboard here.  
If the software keyboard is activated, a keyboard for entering characters or numbers is displayed on the screen.

## Import

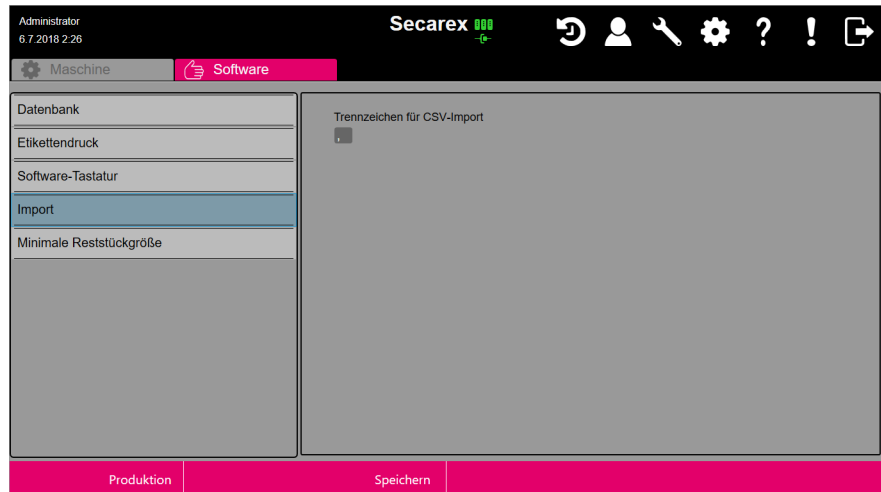

Fig. 32: "Software" tab – "Import" settings

- Enter here the separator used to separate the individual entries for the import of CSV files.  
A comma (",") is entered as default here.

## Minimum residual part size

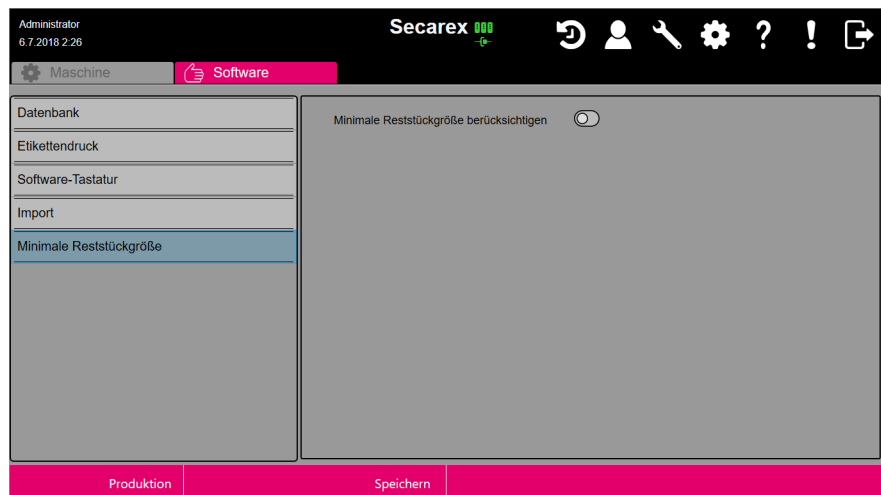

Fig. 33: "Software" tab – "Minimum residual part size" settings

The minimum residual part size is the minimum length of a workpiece that must remain in front of the blade so that the part can be clamped for cutting. This setting should always be activated for machining in automatic mode.

- Activate or deactivate this setting to determine whether the minimum residual part size should be considered when cutting the workpieces.  
If this setting is deactivated, under some circumstances, a workpiece can no longer be securely clamped for machining.

## 7 Maintenance

### 7.1 Safety instructions concerning maintenance work

- There is the general danger that improperly performed repairs, maintenance and adjustment work can endanger persons and/or Secarex AC 18 components. Consequently, the maintenance work listed in this section may be performed only by qualified specialists (see section 2.3 "Operating and specialist personnel").
- More extensive maintenance work not described in these instructions may not be performed by the operating company.
- The personnel for the maintenance work wears the required personal safety equipment (see section 2.4 "Personal protective equipment").
- When performing maintenance work, in particular in the area of the duct tool with removed housing, there is the risk of being crushed or cut at the blade. Consequently, directly after removing the housing, always place the blade protection on the cutter of the duct tool.
- For all maintenance work performed on the Secarex AC 18, the master switch must be switched off by the professionally competent supervisor and secured against being switched on again (see section 5.10 "Switching off the machine").
- The employee responsible for the work carries the key with him/her.
- A sign is attached to the master switch: "Do not switch on! Work being performed in the danger zone!".
- The sign also specifies who initiated the shutdown and who may revoke the shutdown again.
- After completion of the work and before switching the power on again, the responsible supervisor ensures that this is possible without endangering persons or equipment. Before switching on, a timely and unambiguous warning must be issued to all involved persons.
- The supply of compressed air to the machine must also be switched off. This is particularly true for all maintenance work for which the housing of the tools must be removed.
- Some safety devices must be removed so that maintenance work can be performed by the operating company. After completion of the maintenance work, the safety devices must be reinstalled and checked.

### 7.2 Overall maintenance plan

An overall maintenance plan sorted according to the intervals of the individual maintenance work is listed below.

Maintenance work	Interval
Check compressed-air maintenance unit	Daily or as required (see section 7.3.1 "Compressed-air maintenance unit")
Check the linear unit of the feed	Daily or as required (see section 7.3.2 "Linear unit of the feed")
Check the cutting tools	Daily or as required (see section 7.3.3 "Cutting tools")
Check the safety devices	Daily (see section 7.3.3 "Cutting tools")
Clean the linear guides	Daily or as required (see section 7.4.2 "Linear guides")
Clean the viewing window	Daily or as required (see section 7.4.5 "Viewing window")

Tab. 2: Overall maintenance plan

Maintenance work	Interval
Clean the machine	Weekly or as required (see section 7.4.1 "Complete machine")
Clean the sinter filter of the compressed-air maintenance unit	Weekly or as required (see section 7.4.1 "Complete machine")
Clean the cutting tools, including the guides	Monthly or as required (see section 7.4.3 "Cutting tools, including the guides")
Lubricate the track tool	Monthly or as required (see section 7.5.2 "Track tool")
Lubricate the linear guides	Every two months (see section 7.5.1 "Linear guides")
Check the electrical system	Annually or according to country-specific regulations (see section 7.3.4 "Electrical system")
Replace the duct tool/counter blade	As required (see section 7.6.1 "Duct tool")

Tab. 2: Overall maintenance plan

## 7.3 Tests

### 7.3.1 Compressed-air maintenance unit

- Check the pressure set at the compressed-air maintenance unit (see section 5.5 "Connecting the compressed-air supply").
- If necessary, discharge any accumulated condensate from the condensate separator.
- To do this, switch on the supply of compressed air to the machine.

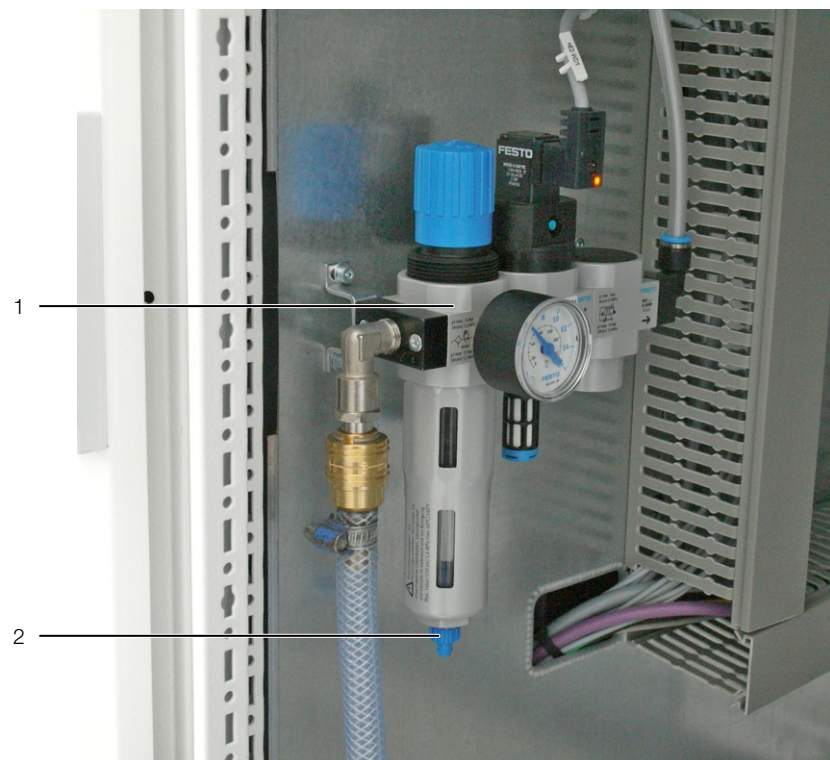

Fig. 34: Compressed-air maintenance unit

#### Key

- 1 Compressed-air maintenance unit
- 2 Drain plug

- Open the drain plug at the lower end of the compressed air maintenance unit. The pressure causes the condensate to discharge from the compressed air maintenance unit.
- Switch off the supply of compressed air to the machine again.

### 7.3.2 Linear unit of the feed

- Switch on the machine completely (see section 5.9 "Switching on the machine") and ensure that the compressed air supply to the machine is switched on.
- Traverse, for example, the length stop in manual operation of the Secarex software (see section 6.3.6 "Manual operation").
- Perform a visual inspection.  
The automatic length stop must travel uniformly and jerk-free.
- Then switch off the machine completely and also the compressed air supply.
- By visually inspecting the automatic length stop through the cut-out, check that no dust or particles have accumulated there.
- If necessary, clean the linear unit (see section 7.4.2 "Linear guides").
- If necessary, relubricate the linear unit (see section 7.5.1 "Linear guides").

### 7.3.3 Cutting tools

- Check the cut edges of the most recently cut wiring ducts, cable duct covers and support rails.  
The cut edges must be straight and burr-free.
- If this is not the case: Inspect the cutting tools for damage and replace the duct tool if necessary (see section 7.6.1 "Duct tool").

### 7.3.4 Electrical system



#### Warning!

**Work on electrical systems or equipment may be performed only by an electrician or by trained personnel under the guidance and supervision of an electrician. All work must be performed in accordance with electrical engineering regulations.**

- Have a qualified electrician check and document the continuity of the PE conductor system and the insulation resistance of live conductors in accordance with DIN EN 60204-1.
- Also observe any additional valid stationary directives and regulations.
- In the event of a repair or change of a part: Have the affected part rechecked before the machine is switched on.

## 7.4 Cleaning



#### Note:

When performing the individual work tasks, also observe the accompanying documents of the associated components.

### 7.4.1 Complete machine

The complete machine, in particular, the table and the screen, must be cleaned of machining residues and other contaminations regularly and when required.



#### Note:

Never use aggressive cleaning substances or abrasives for cleaning the screen, because they can attack the surface of the screen.

- Switch off the machine completely at the master switch.
- Sweep or vacuum the table.

- Clean the screen with a soft cloth.
- Check that the labels on the machine are complete and easy to read (see section 3.1.5 "Safety and warning components"). Replace any damaged labels without delay.

#### 7.4.2 Linear guides

The linear guides of the automatic length stop must be cleaned of dust and particles regularly and when required.

- If during the visual inspection (see section 7.3.2 "Linear unit of the feed") you determine that contaminations are present on the shafts: Loosen the fastening screws of the covers at the rear of the machine and remove them.
- To prevent damage to the linear guides, remove any contaminations on them without delay.
- If necessary, apply grease to the guides (see section 7.5.1 "Linear guides").
- Finally, replace the service cover and secure it on the desktop.

#### 7.4.3 Cutting tools, including the guides

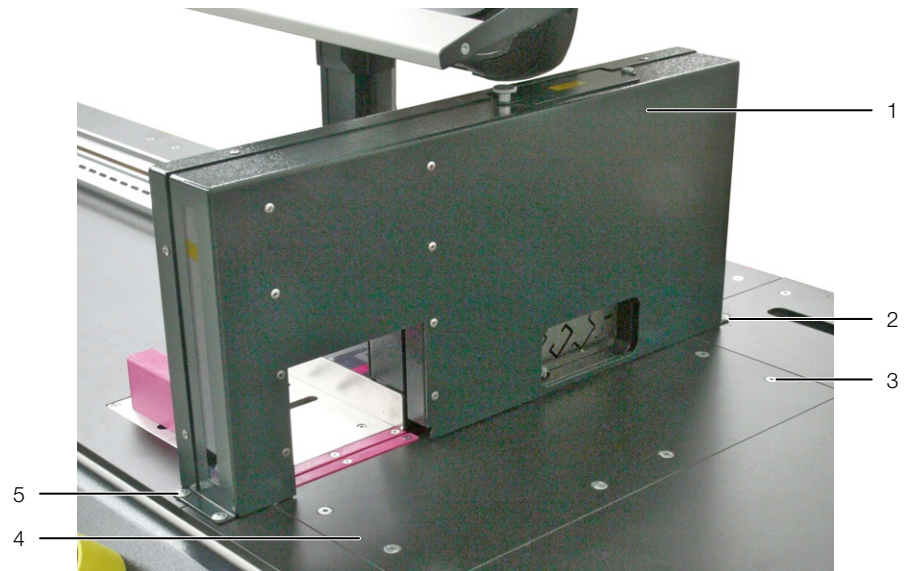

Fig. 35: Safety fence of the tools

##### Key

- |   |                                                  |
|---|--------------------------------------------------|
| 1 | Safety fence                                     |
| 2 | "Rear" fastening screw (2x)                      |
| 3 | Counter blade service cover fastening screw (6x) |
| 4 | Counter blade service cover                      |
| 5 | "Front" fastening screw (2x)                     |

- Loosen and remove each of the two SW 4 fastening screws at the front and rear on the safety fence.
- Remove the safety fence upwards.
- Place the blade protection on the duct tool.

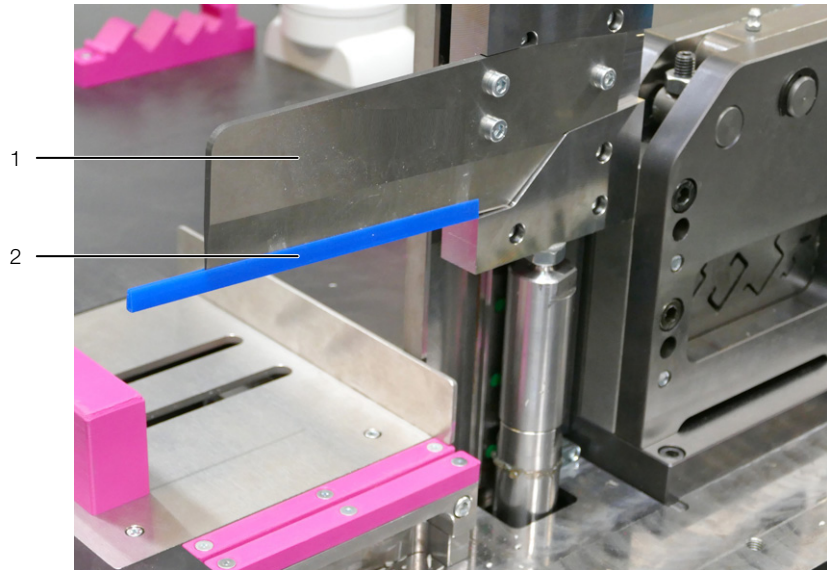

Fig. 36: Blade protection

**Key**

- 1 Duct tool
- 2 Blade protection

- Loosen and remove the six SW 4 fastening screws of the counter blade service cover.
- Open the door of the pneumatic cabinet and press the service cover slightly upwards so it can be removed easier.

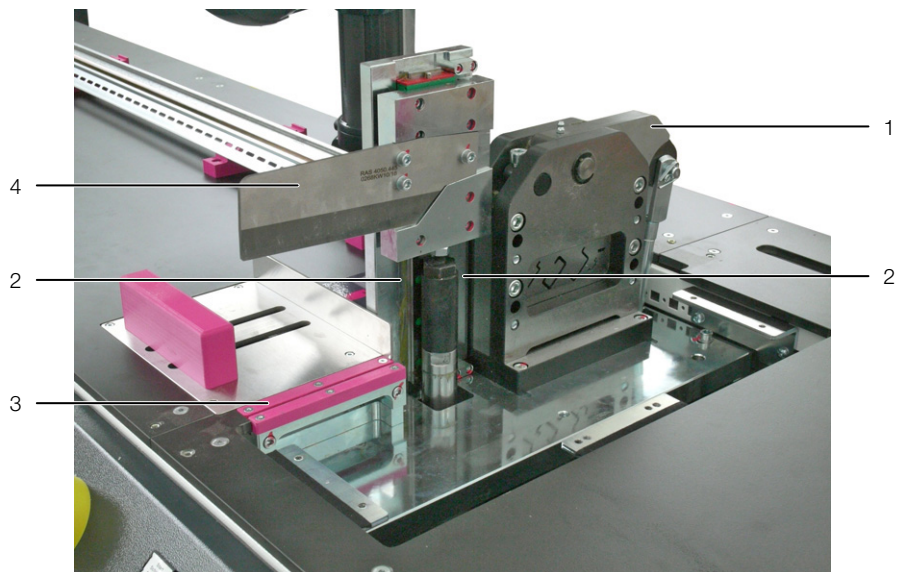

Fig. 37: Tools

**Key**

- 1 Track tool
- 2 Duct tool guides
- 3 Duct tool counter blade
- 4 Duct tool

- Clean the area below the counter blade service cover of any dust and particles.
- Clean the guides and contact surfaces of the cutting tools.
- If necessary, apply oil or grease to the cutting tools (see section 7.5.2 "Track tool").
- Finally, reattach the safety fence.



#### 7.4.4 Compressed-air maintenance unit

- Check the sinter filter for contaminations.
- Clean the sinter filter or replace it with a new compatible one.

#### 7.4.5 Viewing window



##### **Caution! Risk of being cut by the duct tool!**

**There is risk of injury at the stationary blade even when the machine is switched off. Never clean the viewing window directly on the machine when the safety fence is installed.**

- To clean the viewing window, first remove the safety fence from the tools (see section 7.4.3 "Cutting tools, including the guides").
- Then clean the viewing window in the safety fence of the tools as required and in regular intervals inside and outside using a soft, lightly moistened cloth.
- Moisten the cloth with water (max. 60 B0C) or isopropyl alcohol.
- Finally, reattach the safety fence.

### 7.5 Lubrication



#### Note:

When performing the individual work tasks, also observe the accompanying documents of the associated components.

#### 7.5.1 Linear guides

The linear guides are lubricated using a grease gun at the greasing nipples located on the face side of the shaft slides. The lubrication is performed in regular intervals or when the visual inspection reveals imperfections in the lubricating film or contaminations on the steel shafts.

- First clean the shafts and the greasing nipple (see section 7.4.2 "Linear guides").
- Place the grease gun on the clean greasing nipple and press in one shot of lubricant.
- Move the shaft slides backwards and forwards several times to distribute the applied lubricant.
- Reapply lubricant until the required quantity of lubricant is present.
- Use the following grease (or a comparable product) for lubrication:
  - Sodium-saponified grease GP00/00F-20 according to DIN 51 502
  - Required grease quantity: 1 cmB3

#### 7.5.2 Track tool

Unlike the duct tool, the track tool must be greased rather than being oiled.

- Open the service flap upwards in the area of the track tool.
- Clean the greasing nipple.

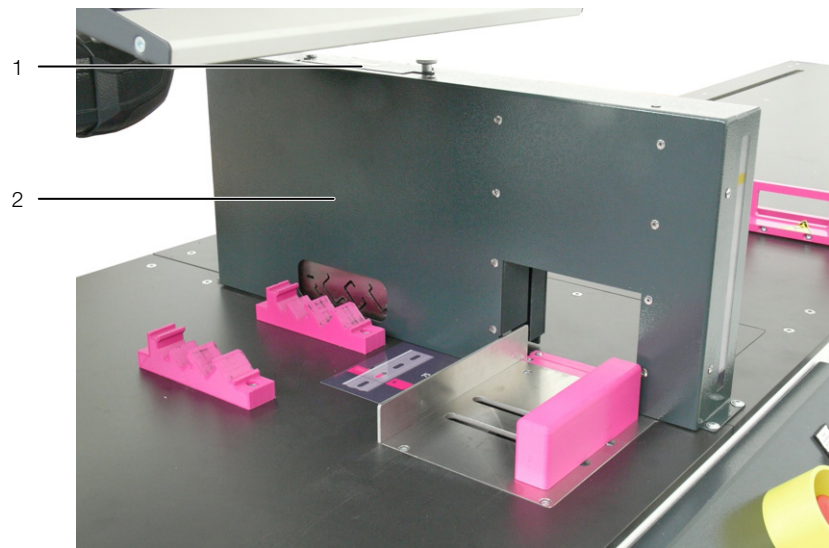

Fig. 38: Service flap

### Key

- 1 Service flap
- 2 Safety fence

- Place the grease gun on the clean greasing nipple and press in one shot of lubricant.
- Move the tool upwards and downwards several times to distribute the applied lubricant.
- Reapply lubricant until the required quantity of lubricant is present.
- Use the following grease (or a comparable product) for lubrication:
  - Sodium-saponified grease GP00/00F-20 according to DIN 51 502
- Close the service flap again.

## 7.6 Replacement



### Note:

When performing the individual work tasks, also observe the accompanying documents of the associated components.

### 7.6.1 Duct tool



#### **Caution! Risk of being cut by the duct tool!**

**Always wear your personal protective equipment when replacing the duct tool (see section 2.4 "Personal protective equipment").**

The duct tool can be replaced if necessary.

- First remove the safety fence from the tools (see section 7.4.3 "Cutting tools, including the guides").
- Place the blade protection on the duct tool (fig. 36).
- Loosen the three fastening screws of the duct tool and remove the tool carefully from the holder.

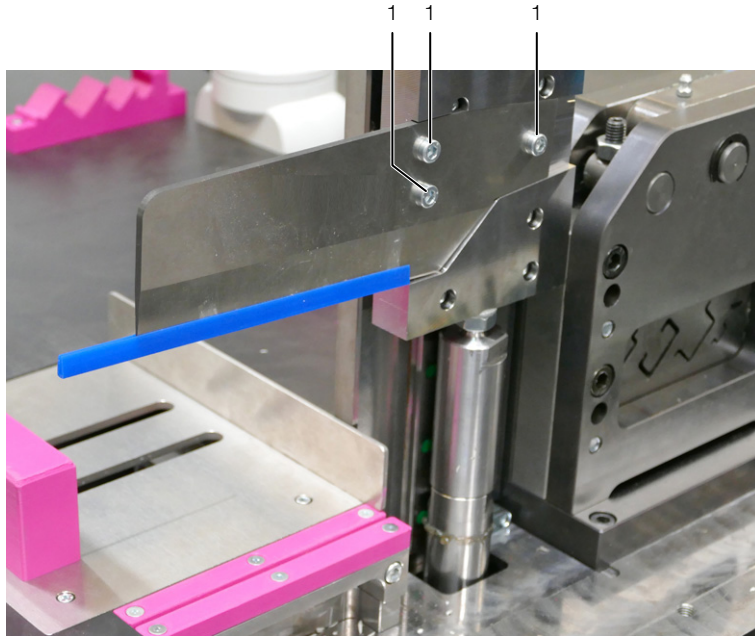

Fig. 39: Fastening screws of the duct tool

**Key**

1 Fastening screw (3 x)

- Place a new, comparable tool on the holder and fasten it with the three fastening screws.
- Reattach the safety fence.

The counter blade of the duct tool can also be replaced if necessary.

- First remove the counter blade service cover (see section 7.4.3 "Cutting tools, including the guides").
- Loosen each of the three fastening screws on both counter blades and remove them from the machine.

You can reinsert the counter blades turned through 180° so that the outer edges lie inside. You can also turn the counter blades through 180° at the longitudinal axis so that the bottom side points upwards. This means each counter blade can be used in four different orientations.

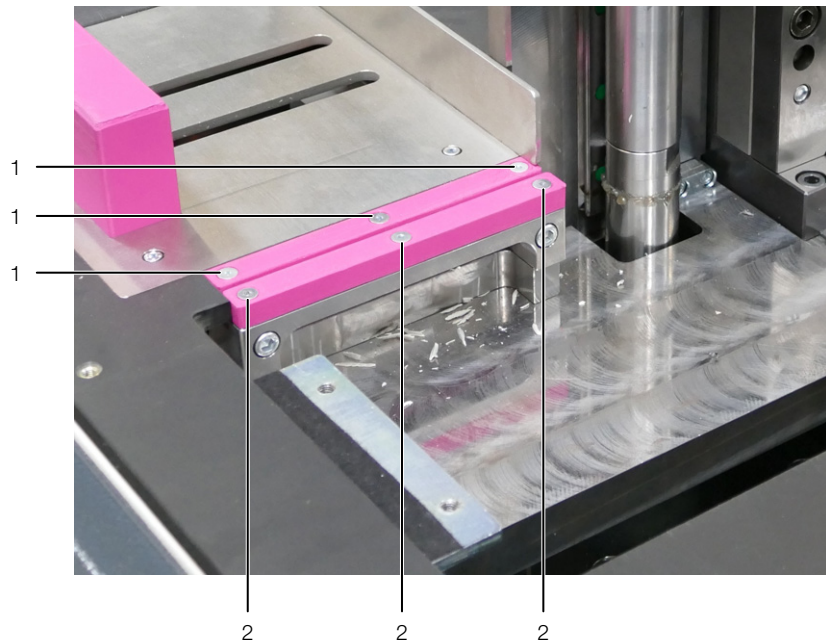

Fig. 40: Fastening screws of the counter blades

### Key

- 1 Counter blade 1 fastening screws (3 x)
- 2 Counter blade 2 fastening screws (3 x)

- If both counter blades were installed in all four possible positions: Install new, identical counter blades in the machine and fasten them with the fastening screws.
- Reattach the counter blade service cover.

### 7.6.2 Track tool

When the track tool is worn or other types of support rails should be shortened, the mounting station with the templates can be replaced completely.

- Contact Rittal Service with regard to an appropriate mounting station.
- Remove the housing of the two tools (see section 7.4.3 "Cutting tools, including the guides").
- Place the blade protection on the duct tool (fig. 36).

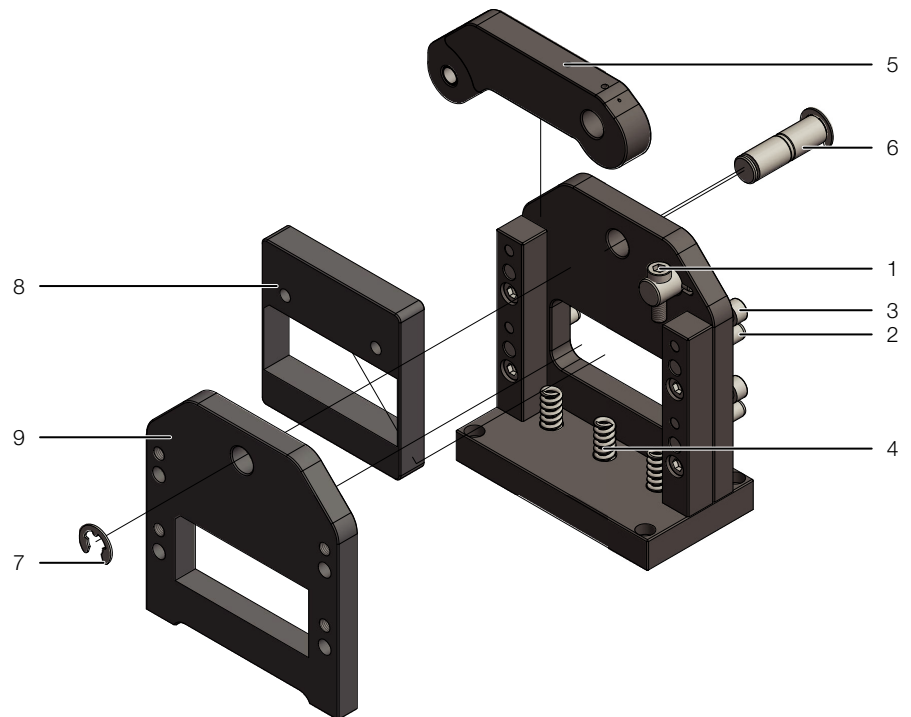

Fig. 41: Replacing the track tool

#### Key

- 1 Screw
- 2 Alignment pins
- 3 Fastening screws
- 4 Springs (3 x)
- 5 Lever
- 6 Axle with safety ring
- 7 Safety ring
- 8 Cutting plate
- 9 Stencil

- Press the cutting plate (item 8) against the springs (item 4) by screwing in the screw (item 1) and so reduce load on the lever (item 5).
- Loosen the safety ring (item 7) of the axle (item 6).
- Pull the axle with safety ring out at the rear.
- Remove the lever.
- Loosen and remove the four screws (item 3).
- Hit the four alignment pins (item 2) from the stencil (item 9).
- Pull the stencil forwards so you have access to the cutting plate with the templates.
- Replace the cutting plate with an identical one or a cutting plate with the desired templates.
- When inserting the new cutting plate, ensure the correct positioning of the three springs below the cutting plate.
- Install all further components in the reverse order.
- Before placing the housing, unscrew the screw (item 1) sufficiently so that the cutting plate is placed at the top on the lever.

The appropriate supports for the support rails are also supplied with each customer-specific cutting plate. They must also be replaced to ensure a seamless safe support of the support rails.

- Replace all supports of the support rails.

Each support is screwed from above with two screws.

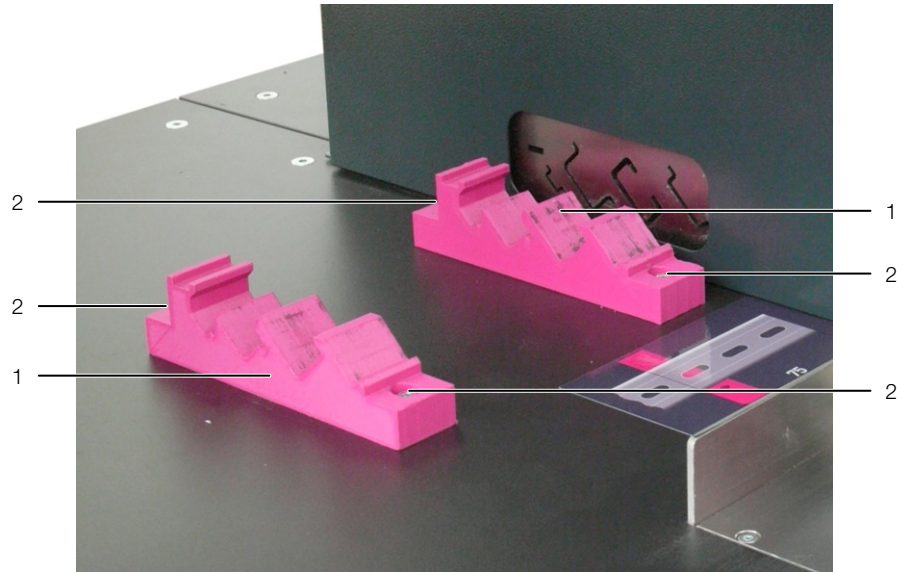

Fig. 42: Replacing the supports

**Key**

- 1 Support
- 2 Fastening screws (each 2x)

## 8 Technical specifications

Technical specifications	
Designation	Rittal Secarex AC 18 cutting centre
<b>Dimensions and weight</b>	
Dimensions (width x height x depth) [mm]	4000 x 1610 x 875
Weight	approx. 630 kg
<b>Electrical connection</b>	
Voltage	1~/N/PE 230 V, 50 Hz
Connection power	1.5 kW
Supply cable cross-section	3 x 1.5 mm <sup>2</sup>
Pre-fuse	16 A
<b>Wiring ducts and cable duct covers maximum dimensions</b>	
Height [mm]	100
Depth [mm]	15...125
Wall thickness [mm]	3...3.5
<b>Support rail types</b>	
Standard tool types	<ul style="list-style-type: none"> <li>– Rittal C rails 30/15 (according to EN 60 715)</li> <li>– NS 35/7.5 (according to EN 60 715)</li> <li>– NS 35/15 (similar to EN 60 715)</li> <li>– NS 15 (according to EN 60 715)</li> <li>– NLS-CU 3/10</li> </ul>
Customer-specific tool types	on request
<b>Compressed-air supply</b>	
Compressed air [bar]	min. 6, max. 8
Compressed air consumption [l/min.]	320
<b>Other information</b>	
Sound pressure level (depends on the workpiece) (open air above reflective flooring, distance 1 m)	max. 79 dB(A) (L <sub>Cpeak</sub> max. 115 dB(A))
Operating temperature range [B0C]	+5...+35
Operating humidity range	20%...80% relative humidity, non-condensing
Storage temperature range [B0C]	-40...+70
Colour	RAL 9003, RAL 4010 and RAL 7016

Tab. 3: Secarex AC 18 technical specifications

## 9 Decommissioning and disposal

### 9.1 Decommissioning

In the event of long- or medium-term interruptions, the Secarex AC 18 must be protected with the following measures:

1. End the visualisation and shutdown the operating system at the operating panel
2. Shut off the compressed-air supply
3. De-energisation of the machine at the master switch and interlocking the master switch
4. Attach a warning label to the master switch

### 9.2 Disposal

Although no special measures must be adopted concerning the Secarex AC 18 disposal, you must observe the following instructions:

- Only trained personnel may disassemble the Secarex AC 18.
- If necessary, contact Rittal concerning the disposal.

The Secarex AC 18 contains parts that must be treated as hazardous waste, for example, electrical circuit boards, cables, various plastic parts and paint coatings.

- Consequently, observe all the usual country laws and regulations for waste disposal!
- Commission a registered disposal company with the proper disposal and reuse.



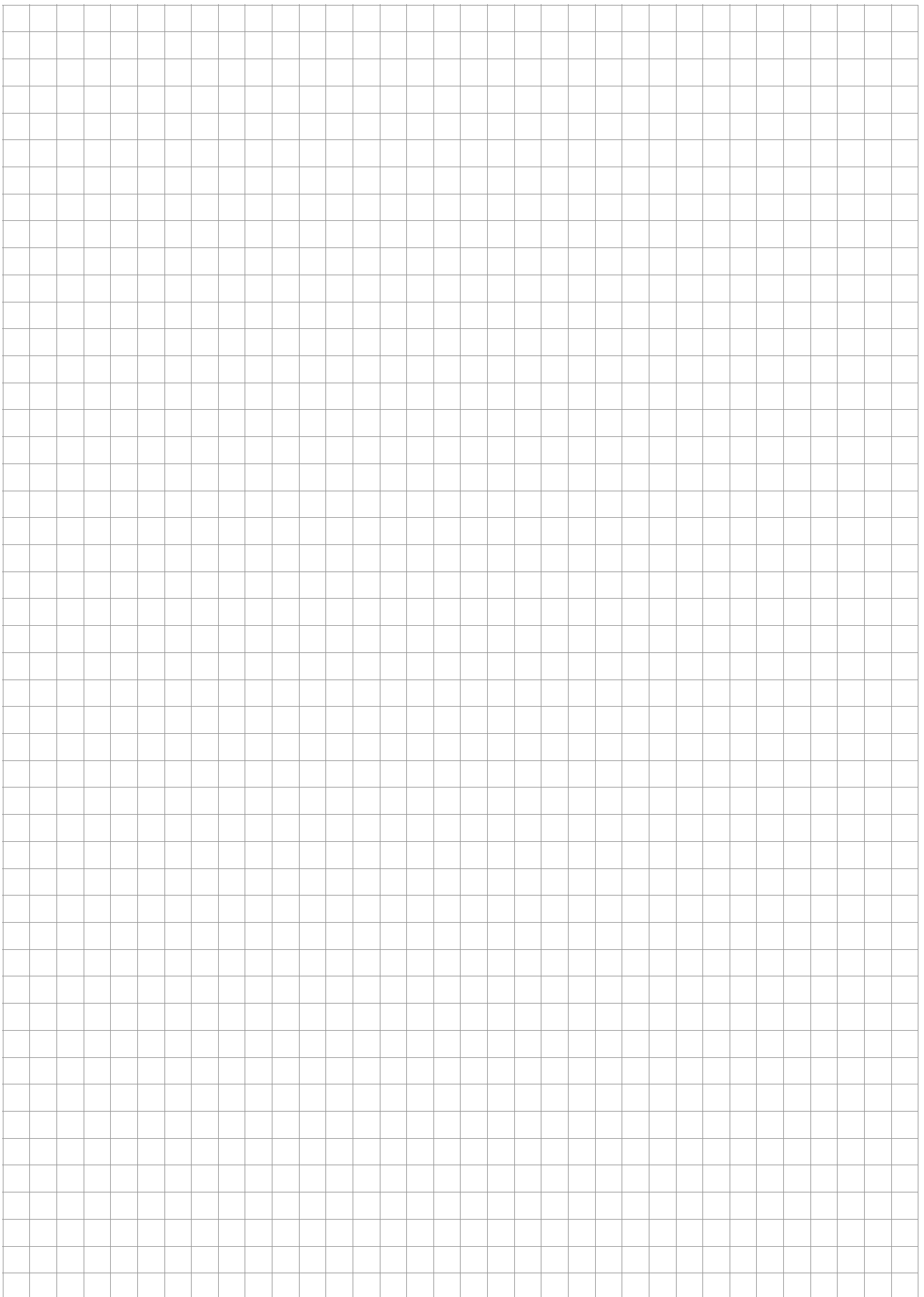

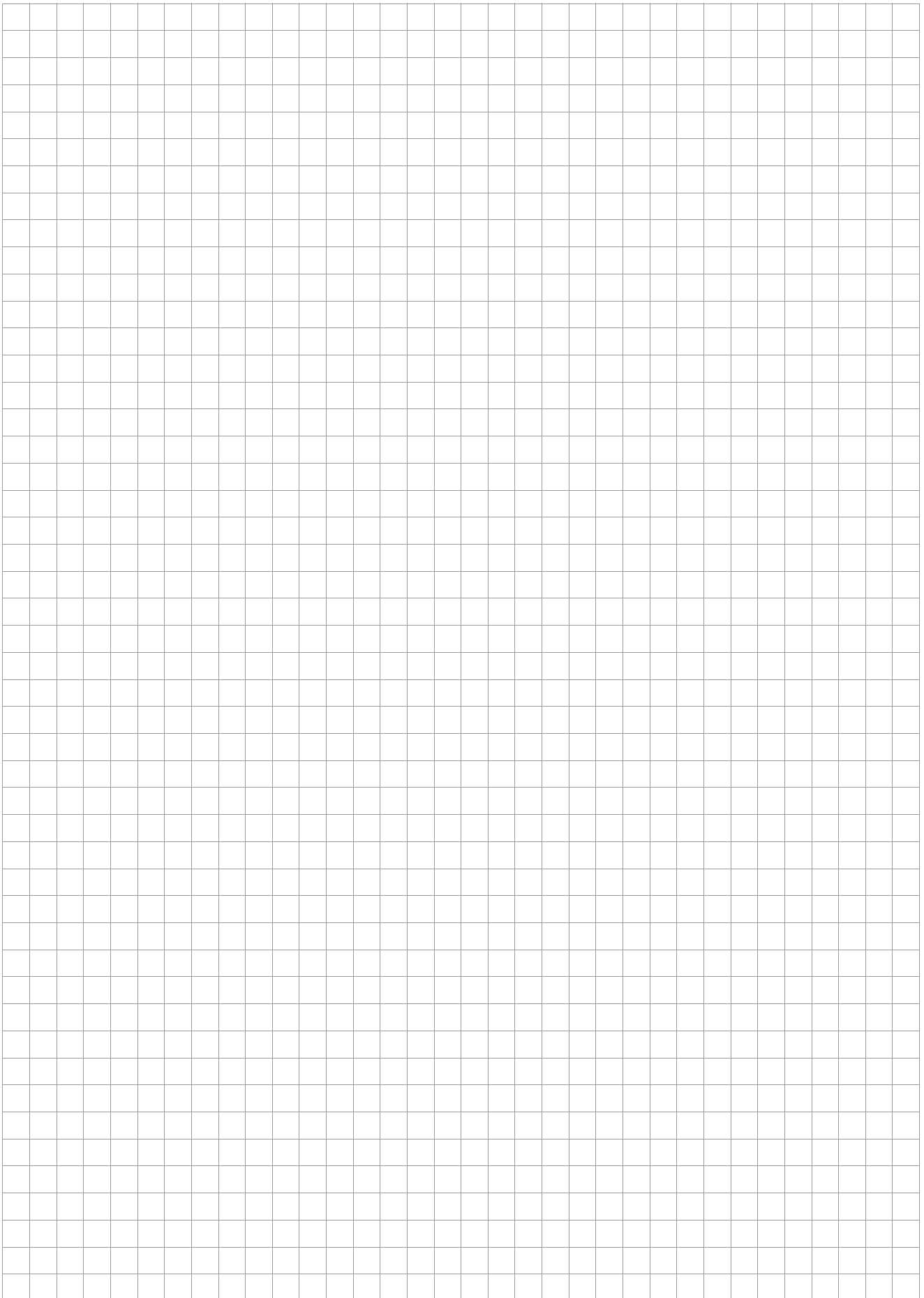

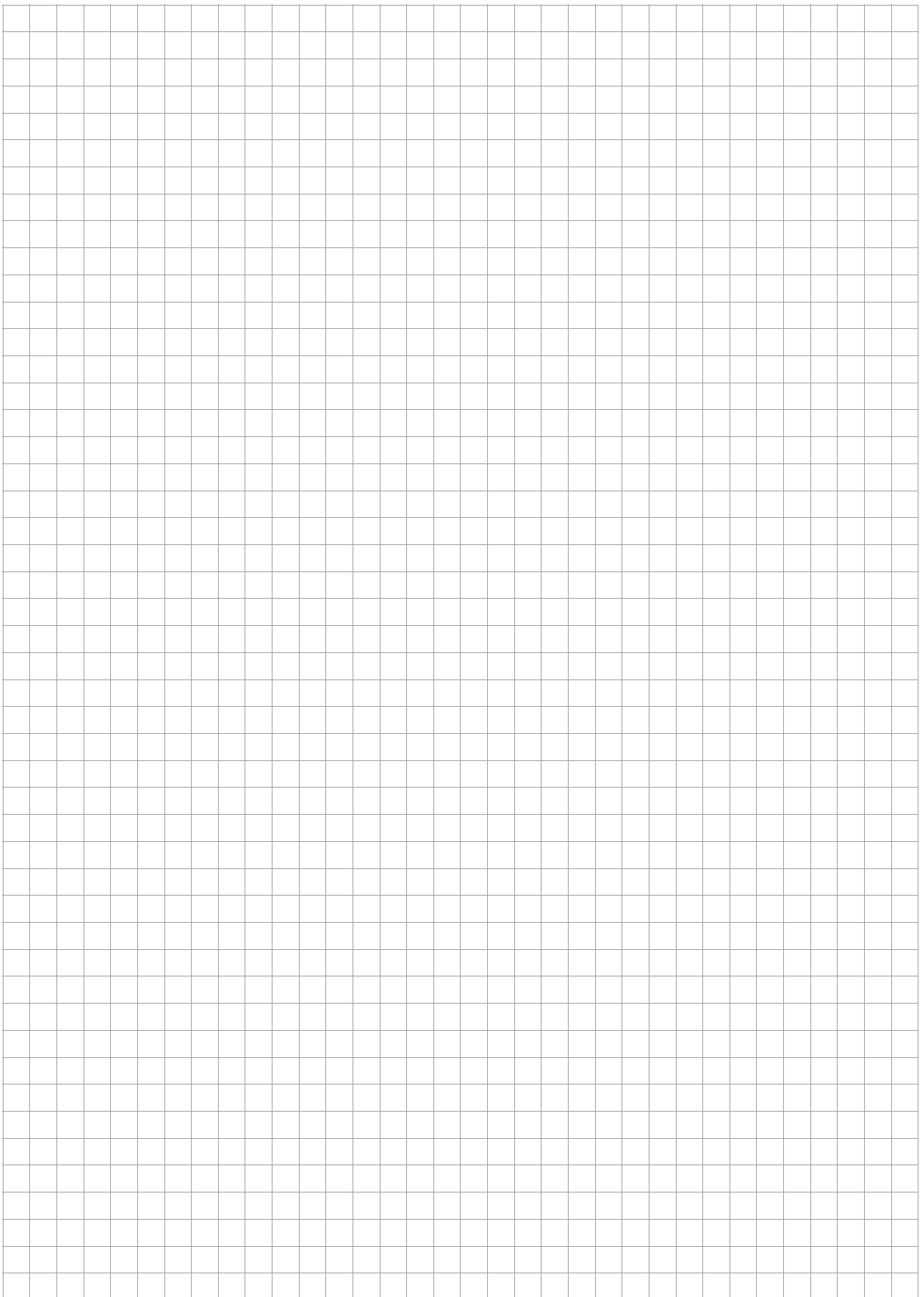

# Rittal – The System.

---

**Faster – better – everywhere.**

- Enclosures
- Power Distribution
- Climate Control
- IT Infrastructure
- Software & Services

01.2019 / D-0100-00000013 Rev. 1

You can find the contact details of all Rittal companies throughout the world here.



[www.rittal.com/contact](http://www.rittal.com/contact)

RITTAL GmbH & Co. KG  
Postfach 1662 · D-35726 Herborn  
Phone +49(0)2772 505-0 · Fax +49(0)2772 505-2319  
E-mail: [info@rittal.de](mailto:info@rittal.de) · [www.rittal.com](http://www.rittal.com)



ENCLOSURES

POWER DISTRIBUTION

CLIMATE CONTROL

IT INFRASTRUCTURE

SOFTWARE & SERVICES

FRIEDHELM LOH GROUP