

Anwendungsbeispiel  
Application example  
Exemple d'application

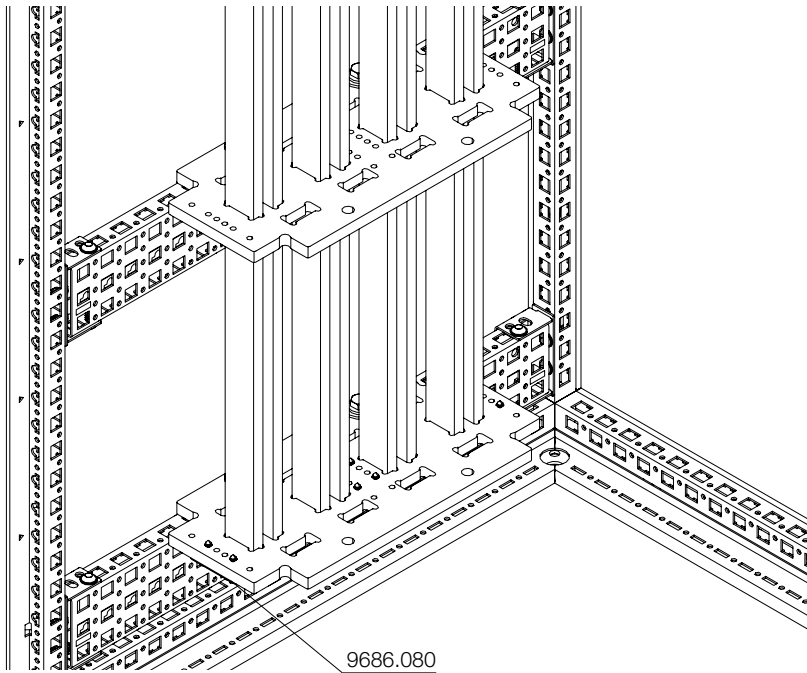
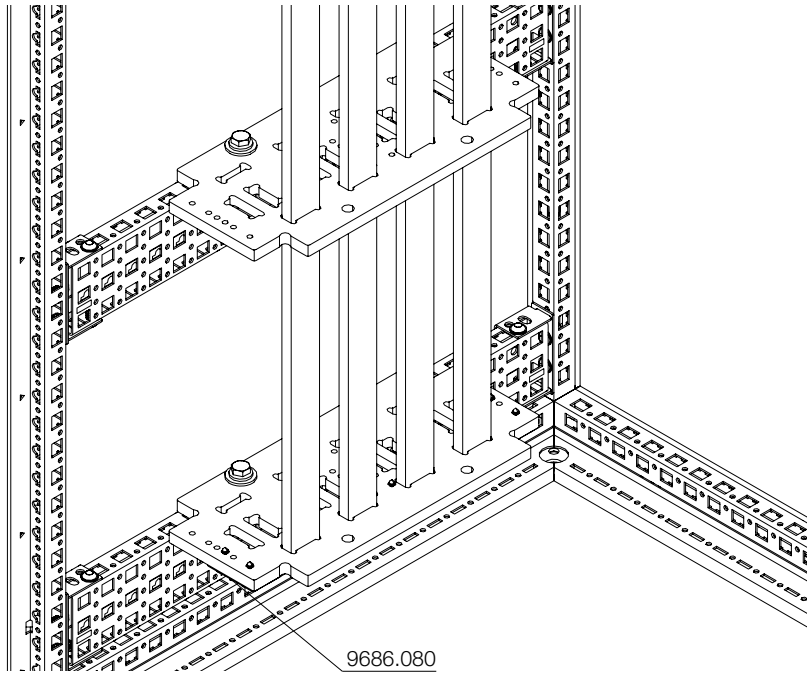

www.rittal.com

SV  
9686.100

CE

2x

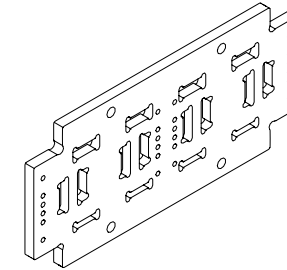

4x

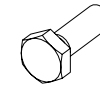

M8x25

4x



Ø8,4 (DIN 6796)

4x



Ø8,4 (DIN 9021)

4x



M8

Dok.-Nr. / No of doc.: D-0000-00001942-02  
Versandbeutel-Nr. / No. of accessory bag: -

Ident-Nr. / Part No.: 342358  
Lieferanten-Nr. / No. of supplier: -

SW13

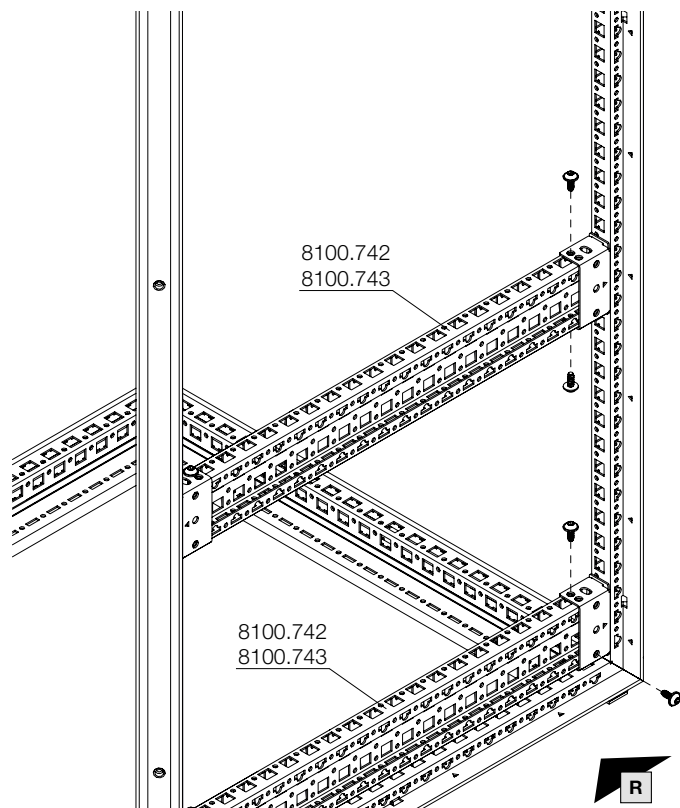

8100.742  
8100.743

8100.742  
8100.743

R

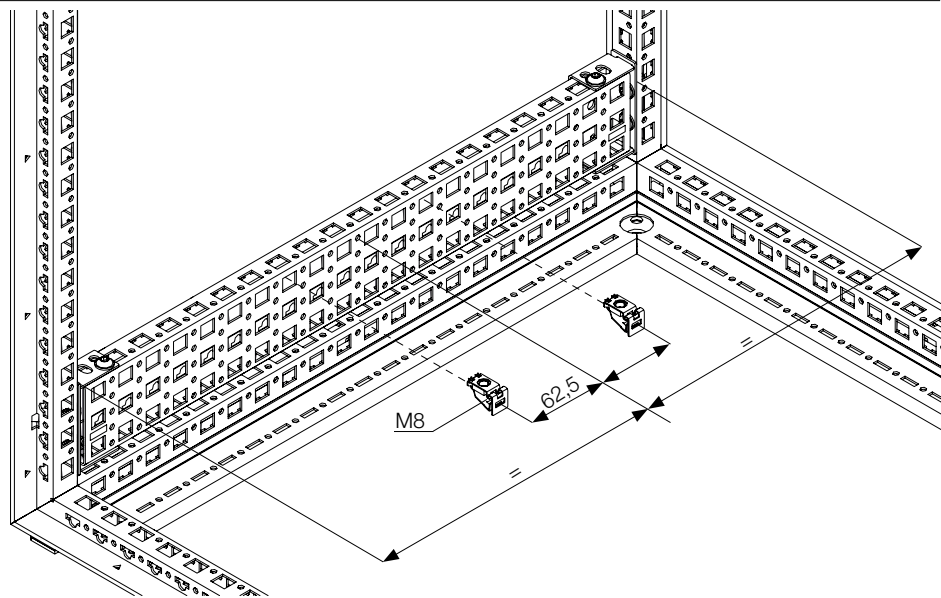

M8

62.5

F

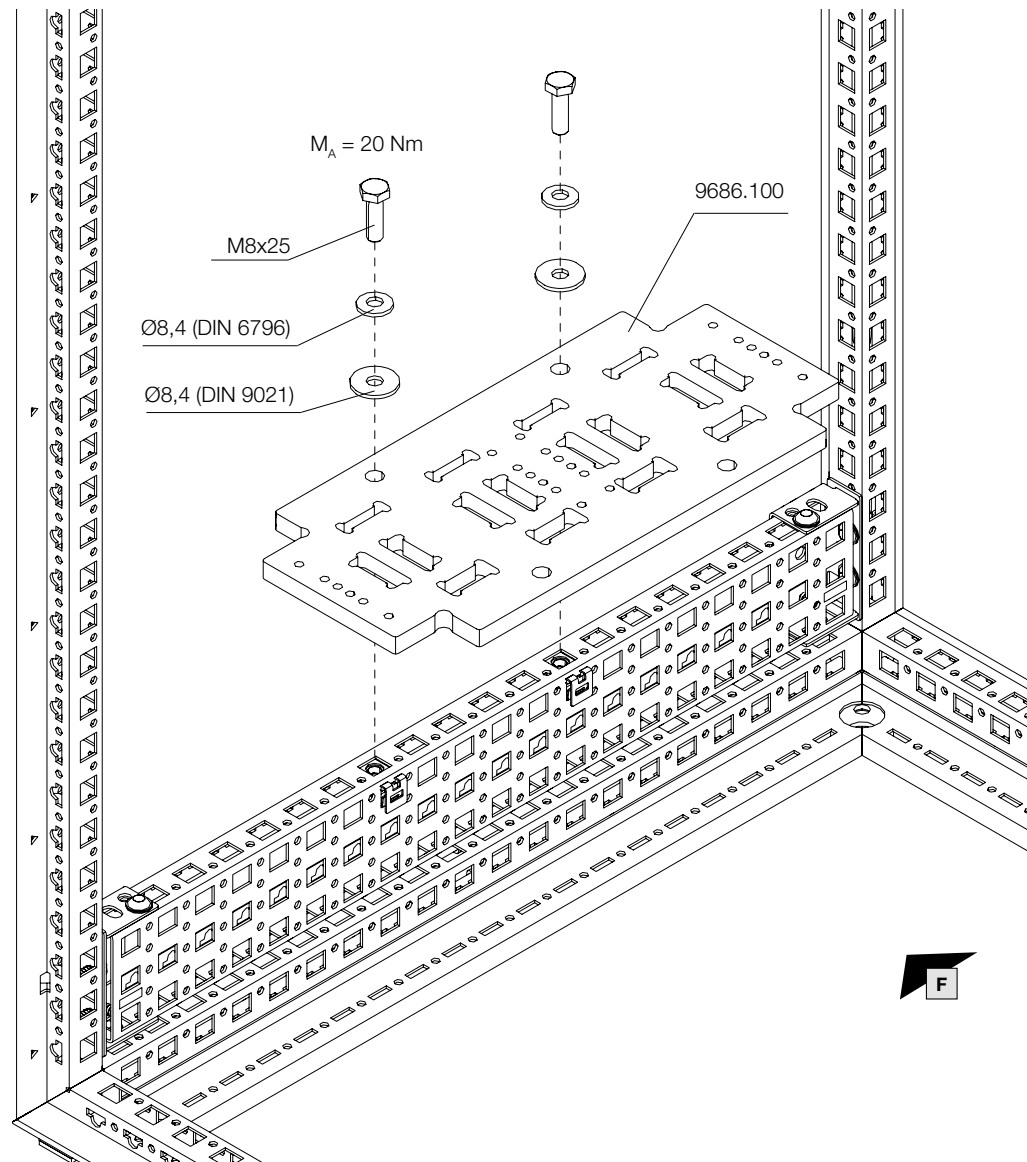

$M_A = 20 \text{ Nm}$

M8x25

Ø8,4 (DIN 6796)

Ø8,4 (DIN 9021)

9686.100

F