

Rittal – The System.

Faster – better – everywhere.

**Bodenblech mehrteilig,
geschlossen für VX IT**
**Gland plate, multi-piece,
solid for VX IT**

**Plaque passe-câbles pleine en
plusieurs parties pour baies VX IT**

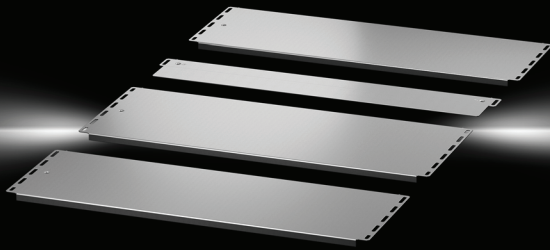

VX IT 5301.336 VX IT 5301.347
VX IT 5301.337
VX IT 5301.338
VX IT 5301.341
VX IT 5301.344

Montageanleitung
Assembly instructions
Notice de montage

ENCLOSURES

POWER DISTRIBUTION

CLIMATE CONTROL

IT INFRASTRUCTURE

SOFTWARE & SERVICES

FRIEDHELM LOH GROUP



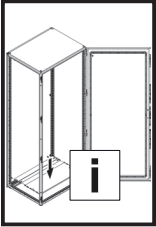

Inhaltsverzeichnis
Contents
Sommaire

DE

1. Hinweise zur Dokumentation	4
1.1 Aufbewahrung der Unterlagen	4
1.2 Verwendete Symbole	4
1.3 Bestimmungsgemäße Verwendung	4
2. Zusätzliches Zubehör	5
3. Sicherheitshinweise	6 – 9
4. Montage Bodenblech mehrteilig, geschlossen	10 – 12

EN

1. Notes on documentation	4
1.1 Storing the documents	4
1.2 Symbols used	4
1.3 Intended use	4
2. Additional accessories	5
3. Safety instructions	6 – 9
4. Mounting the gland plate, multi-piece, solid	10 – 12

FR

1. Remarques relatives à la documentation	4
1.1 Conservation des documents	4
1.2 Symboles utilisés	4
1.3 Utilisation correcte	4
2. Accessoires complémentaires	5
3. Consignes de sécurité	6 – 9
4. Montage de la plaque passe-câbles pleine en plusieurs parties	10 – 12

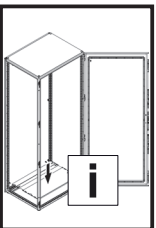

Inhaltsverzeichnis
Contents
Sommaire

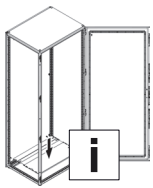

2 – 9

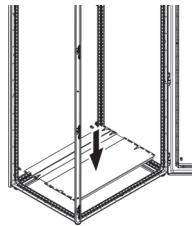

10 – 12

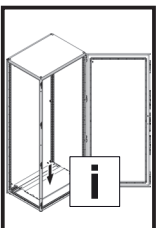

Abkürzungsverzeichnis
Table of abbreviations
Répertoire des abréviations

DE

– M_A: Anzugsdrehmoment



EN

– M_A: Tightening torque

FR

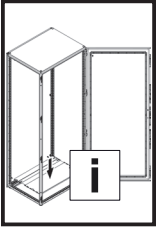
– M_A: Couple de serrage

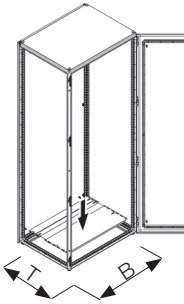
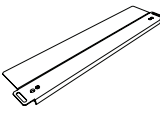
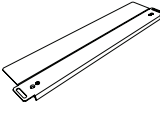
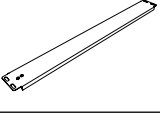
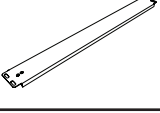
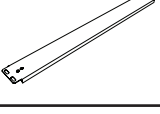
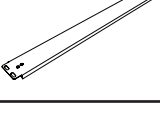
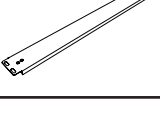
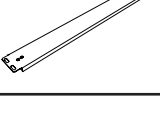

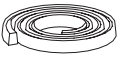
	Bestell.-Nr. Model No. Référence	5301.338	5301.341	5301.336	5301.337	5301.344	5301.347
B [mm]		600	600	800	800	800	800
T [mm]		1000	1200	600	800	1000	1200
	8001.239	1	1				
	8001.241			2	1	1	1
	8001.211			1	1		
	8001.215			1			
	8001.218	2	4				
	8001.219				2	2	4
	8001.222	1			1		
	8001.223					1	
	ST5,5x13	14	14	14	14	14	14
	10x4x4000	1	1	1	1	1	1
	10x4x7500	1	1	1	1	1	1

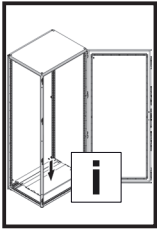

1. Hinweise zur Dokumentation
1. Notes on documentation
1. Remarques relatives à la documentation

DE

Die **Montageanleitung** richtet sich an Personen, die Einrichtungen der Informations- und Telekommunikationstechnik unter Kenntnis der länderspezifischen Sicherheitsvorschriften am Bestimmungsort aufstellen, anschließen und betreiben.

1.1 Aufbewahrung der Unterlagen

Die Dokumentation ist Teil des Produktes. Sie muss dem Anlagenbetreiber ausgehändigt werden. Dieser übernimmt die Aufbewahrung, damit die Unterlagen im Bedarfsfall zur Verfügung stehen.

1.2 Verwendete Symbole

Beachten Sie folgende Sicherheits- und sonstige Hinweise in der Anleitung:

Sicherheits- und andere Hinweise:



Gefahr!
Unmittelbare Gefahr für Leib und Leben.



Achtung!
Mögliche Gefahr für Produkt und Umwelt.



Hinweis:
Nützliche Informationen und Besonderheiten.



Hinweis:
Front-/Rückansicht.

EN

These **assembly instructions** have been written for personnel tasked with assembling, connecting and operating IT and telecommunications equipment at the intended location and who are familiar with the country-specific safety regulations.

1.1 Storing the documents

The safety notes and the accompanying note are part of the product. They must be given to the plant operator, who is then responsible for the storage of the documents so that they are readily available when needed

1.2 Symbols used

Please observe the following safety instructions and other notes in this guide:

Safety and other notes:



Danger!
Immediate danger to life and limb.



Caution!
Potential threat to the product and its environment.



Note:
Useful information and special features.



Note:
Front/rear view.

FR

La **notice de montage** s'adresse aux personnes qui installent, raccordent et exploitent les installations IT et de télécommunication, dans le respect des prescriptions de sécurité spécifiques au pays où elles sont installées.

1.1 Conservation des documents

Les consignes de sécurité et la notice jointe font partie du produit. Elles doivent être remises à l'exploitant de l'installation. Celui-ci les conservera de manière à ce qu'elles soient disponibles en cas de besoin.

1.2 Symboles utilisés

Tenir compte des consignes de sécurité et autres directives contenues dans cette notice :

Consignes de sécurité et autres directives :



Danger !
Risque de blessure grave, voire mortelle.



Attention !
Danger éventuel pour le produit et l'environnement.



Remarque :
Informations utiles et particularités.



Remarque :
F = vue frontale
R = vue arrière

1.3 Bestimmungsgemäße Verwendung

Die Bodenbleche dienen zur räumlichen, zugriffgeschützten Trennung zweier Installationsbereiche oder Schranksysteme sowie zum Schutz gegenüber dem Eintrag von Staub oder Feuchtigkeit (Wasser) im Rahmen einer schutzartgerechten Abschottung (IP) gegenüber dem Außenbereich des Gehäuses entsprechend den Vorgaben der Norm IEC 60529 (EN 60529).

1.3 Intended use



The gland plates are used for spatial, access-protected separation of two installation areas or enclosure systems and for protection from the ingress of dust or humidity (water) as part of protection category-compatible shielding (IP) from the enclosure exterior as prescribed by standard IEC 60529 (EN 60529).

1.3 Utilisation correcte

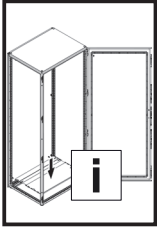
Les plaques passe-câbles servent à la séparation physique avec protection d'accès de deux espaces d'installation ou systèmes d'armoires ainsi qu'à la protection contre la pénétration de poussière ou d'humidité (eau) dans le cadre d'un cloisonnement efficace (IP) vis-à-vis de l'extérieur de la baie conformément aux prescriptions de la norme CEI 60529 (EN 60529).

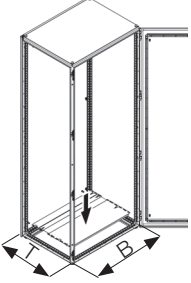
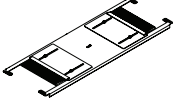
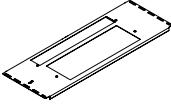
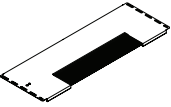
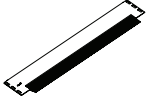

2. Zusätzliches Zubehör
2. Additional accessories
2. Accessoires complémentaires

	Bestell.-Nr. Model No. Référence		
B [mm]		800	600
T [mm]		237,5	237,5
	5301.348	x	
	5301.330		x
	5301.331	x	
	5301.332		x
	5301.333	x	
 	5301.334		x
	5301.335	x	

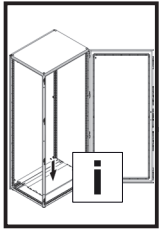

3. Sicherheitshinweise
3. Safety instructions
3. Consignes de sécurité

3. Veiligheidsvoorschriften
3. Säkerhetsinstruktioner
3. Istruzioni di sicurezza

3. Instrucciones de seguridad

	DE	EN	FR	NL	SE	IT	ES
	Warnung vor der Schließbewegung von mechanischen Teilen einer Maschine/Einrichtung	Warning against closing movements for mechanical parts of a machine/device	Danger dû à la fermeture de pièces mécaniques d'une machine / installation	Waarschuwing voor de sluitbeweging van mechanische onderdelen van een machine/voorziening	Varning för stängningsrörelse på mekaniska delar i en maskin/enhet	Prestare attenzione alla chiusura delle parti meccaniche di una macchina o di un dispositivo	Atención, movimiento de cierre de componentes mecánicos en una máquina/instalación
	Warnung vor sich bewegenden mechanischen Teilen	Warning against independently moving parts	Danger dû à des pièces mécaniques mobiles	Waarschuwing voor bewegende mechanische onderdelen	Varning för rörliga mekaniska delar	Prestare attenzione alle parti meccaniche in movimento	Atención, componentes mecánicos en movimiento
	Warnung vor Umkippen durch Schwerpunktverlagerung	Risk of tipping due to displacement of centre of gravity	Attention au basculement lors du déplacement du centre de gravité	Waarschuwing voor kantelen als gevolg van zwaartepuntverschuiving	Varning för vältande föremål på grund av förskjutet tyngdpunkt	Pericolo di cadute tramite lo spostamento del baricentro	Advertencia de vuelco si se desplaza el centro de gravedad
	Warnung vor spitzem Gegenstand	Caution: Sharp object	Attention aux objets pointus	Waarschuwing voor scherpe voorwerpen	Varning för vassa föremål	Pericolo oggetto affilato	Advertencia de objetos puntiagudos
	Warnung vor Hindernissen am Boden	Caution: Obstructions on floor	Attention aux obstacles au sol	Waarschuwing voor obstakels op de grond	Varning för hinder på marken	Pericolo ostacolo in basso	Advertencia de obstáculos en el suelo
	Warnung vor schweren Lasten	Caution: Heavy loads	Attention aux charges lourdes	Waarschuwing voor zware belastingen	Varning för tung last	Pericolo carichi pesanti	Advertencia de cargas pesadas
	Warnung vor Hindernissen im Kopfbereich	Caution: Obstructions in head area	Attention aux obstacles au niveau de la tête	Waarschuwing voor obstakels op hoofdhoogte	Varning för hinder i huvudhöjd	Pericolo ostacolo in alto	Advertencia de obstáculos en la zona de la cabeza
	Die Anleitung ist zu lesen	The instructions must be read	La notice doit être lue	Lees de gebruiksaanwijzing	Bruksanvisningen måste läsas	Leggere le istruzioni	Leer el manual de instrucciones

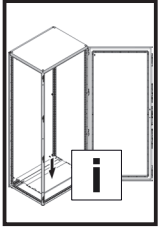

3. Turvallisuusohjeet
3. Sikkerhedsanvisninger
3. Wskazówki dotyczące bezpieczeństwa

3. Bezpečnostní pokyny
3. Инструкции за безопасност
3. Меры безопасности

	FI	DK	PL	CZ	BG	RU
	Varoitus koneen/laitteen mekaanisten osien sulkuliikkeestä	Advarsel mod lukkebevægelse af mekaniske dele i en maskine/indretning	Uwaga na zamykające się części mechaniczne maszyny lub urządzenia	Výstraha před rizikem úrazu ruky	Предупреждение за движение от затварящи се механични части на машина/оборудване	Предупреждение об опасности при закрывании механических частей машины/установки
	Varoitus liikkuvista mekaanisista osista	Advarsel mod uafhængigt bevægelige dele	Uwaga na ruchome części mechaniczne	Výstraha; Rozmačkání	Предупреждение за движещи се механични части	Предупреждение об опасности движущихся механических частей
	Varo: painopisteen siirtymisestä johtuva kaatumisvaara	Risiko for væltning på grund af forskydning af tyngdepunktet	Ostrzeżenie przed przewróceniem się z powodu przesunięcia środka ciężkości	Varování před převrácením způsobeným posunutím těžiště	Предупреждение за опасност от преобръщане поради изместване на центъра на тежестта	Предупреждение об опрокидывании ввиду смещения центра тяжести
	Varo teräviä reunoja	Advarsel: Spidse genstande	Ostrzeżenie przed ostrym przedmiotem	Varování před ostrým předmětem	Предупреждение за опасност от остър предмет	Предупреждение об остром предмете
	Varo: kompastumisvaara	Advarsel: Forhindringer på gulvet	Ostrzeżenie przed przeszkodami na podłożu	Varování před překážkami na zemi	Предупреждение за опасност от препятствия по земята	Предупреждение о препятствиях на полу
	Varo raskasta kuormaa	Advarsel: Tunge belastninger	Ostrzeżenie przed dużymi ciężarami	Varování před těžkými břemeny	Предупреждение за опасност от тежки товари	Предупреждение о тяжелых грузах
	Varo putoavia esineitä	Advarsel: Forhindringer i hovedhøjde	Ostrzeżenie przed przeszkodami w pobliżu głowy	Varování před překážkami v oblasti hlavy	Предупреждение за опасност от препятствия в областта около главата	Предупреждение о препятствиях в верхней области головы
	Lue käyttöohjeet	Veiledningen skal læses	Przeczytać instrukcję	Odkaz na instrukce návodu k použití/brožury	Прочетете ръководството	Прочитать руководство

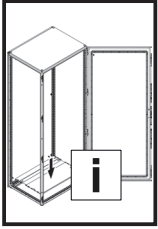

3. Υποδείξεις ασφαλείας
3. Instrucțiuni de siguranță
3. Sigurnosne upute

3. Biztonsági utasítások
3. Saugos nurodymai
3. Ohutusjuhised

3. Drošības norādījumi



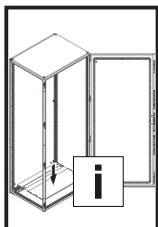





	GR	RO	HR	HU	LT	EE	LV
	Προειδοποίηση πριν από την κίνηση κλειδώματος μηχανικών μερών μίας εγκατάστασης/μηχανήματος	Avertizare cu privire la mișcarea de închidere a pieselor mecanice ale unei mașini/ale unui dispozitiv	Upozorenje na opasnost od uklještenja mehaničkih dijelova stroja/uređaja	Gép/berendezés mechanikai részeinek zárómozgására történő figyelmeztetés	Įspėjimas dėl mašinos / įrenginio mechaninių dalių judėjimo, užsidarymo metu	Hoiatus masina/ seadme mehhaaniliste osade sulgemisliikumise eest	Uzmanieties iekārtas/mašīnas mehānisko daļu aizvēršanās laikā
	Προειδοποίηση από κινούμενα μηχανικά μέρη	Avertisment cu privire la piesele mecanice aflate în mișcare	Upozorenje na mehaničke dijelove koji su u pokretu	Mozgó mechanikai részekre történő figyelmeztetés	Įspėjimas dėl judančių mechaninių dalių	Hoiatus liikuvate mehhaaniliste osade eest	Uzmanieties no kustīgām mehāniskām daļām
	Προειδοποίηση ανατροπής λόγω μετατόπισης του κέντρου βάρους	Avertizare de răsturnare prin deplasarea centrului de greutate	Upozorenje na prevrtanje zbog pomicanja težišta	Figyelmeztetés a feldőlés veszélyére a súlypont eltolódása miatt	Įspėjimas apie galimą apvirtimą dėl svorio centro perkėlimo	Hoiatus ümberkukkumise eest raskuskeskme nihkumise tõttu	Brīdinājums par apgāšanos smaguma centra novirzīšanās dēļ
	Προειδοποίηση αιχμηρού αντικειμένου	Avertizare privind obiecte ascuțite	Upozorenje na šiljati predmet	Figyelmeztetés hegyes tárgyak veszélyére	Įspėjimas apie aštrų daiktą	Hoiatus terava eseme eest	Brīdinājums par asiem priekšmetiem
	Προειδοποίηση για εμπόδια στο έδαφος	Avertizare privind obstacole la sol	Upozorenje na zapreke na tlu	Figyelmeztetés a padlón található akadályokra	Įspėjimas apie kliūtis ant žemės	Hoiatus põrandal asuvate takistuste eest	Brīdinājums par šķēršļiem uz grīdas
	Προειδοποίηση για βαριά φορτία	Avertizare privind sarcini grele	Upozorenje na teške terete	Figyelmeztetés nehéz teherre	Įspėjimas apie sunkius krovinius	Hoiatus raskete koormate eest	Brīdinājums par lielu slodzi
	Προειδοποίηση για εμπόδια στην περιοχή της κεφαλής	Avertizare privind obstacole în zona capului	Upozorenje na zapreke u području glave	Figyelmeztetés fejmagasságban található akadályokra	Įspėjimas apie kliūtis galvos aukštyje	Hoiatus pea piirkonnas asuvate takistuste eest	Brīdinājums par šķēršļiem galvas zonā
	Απαιτείται το διάβασμα των οδηγιών	A se citi manualul	Pročitajte upute	Az utasítást el kell olvasni	Skaityti instrukciją	Lugeda kasutusjuhendit	Izlasiet instrukciju



3. Varnostni napotki

3. Bezpečnostné pokyny

3. Instruções de segurança

	SI	SK	PT
	Opozorilo pred zapiranjem mehanskih delov stroja/naprave	Dávajte pozor na zatvárací pohyb mechanických častí stroja/zariadenia	Cuidado quando as partes mecânicas de uma máquina/instalação se fecham
	Opozorilo pred premikajočimi se mehanskimi deli	Dávajte pozor na pohyblivé mechanické časti	Cuidado com as partes mecânicas móveis
	Opozorilo pred prevrnitvijo zaradi spremenjenega težišča	Varovanie pred prevrátením v dôsledku premenenia ťažiska	Cuidado com o risco de queda pelo deslocamento do centro de gravidade
	Opozorilo pred ostrim predmetom	Varovanie pred predmetom s ostrým hrotom	Cuidado com objetos pontiagudos
	Opozorilo pred ovirami na tleh	Varovanie pred prekážkami na podlahe	Cuidado com objetos no chão
	Opozorilo pred težkimi bremenami	Varovanie pred ťažkými bremenami	Cuidado com cargas pesadas
	Opozorilo pred ovirami v višini glave	Varovanie pred prekážkami v priestore hlavy	Cuidado com objeto à altura da cabeça
	Preberite navodila	Prečítajte si návod	Ler as instruções

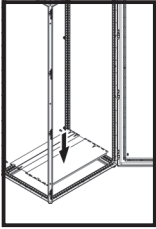

4. Montage Bodenblech mehrteilig, geschlossen
4. Mounting the gland plate, multi-piece, solid
4. Montage de la plaque passe-câbles pleine en plusieurs parties

600 x 1200

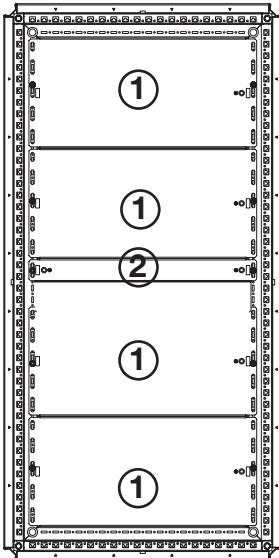

600 x 1000

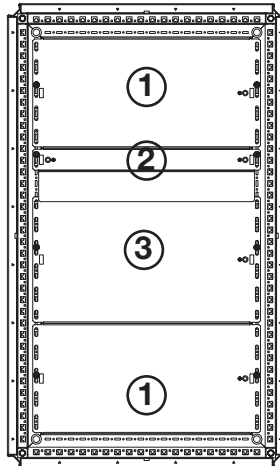

800 x 1200

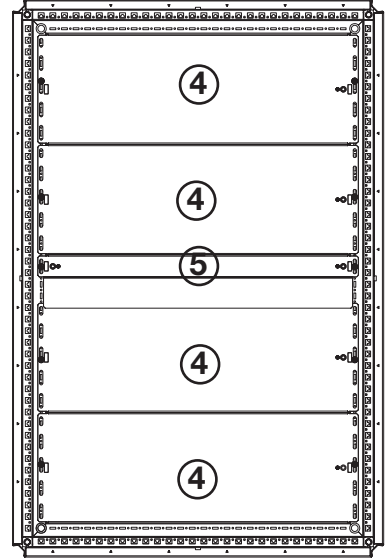

800 x 1000

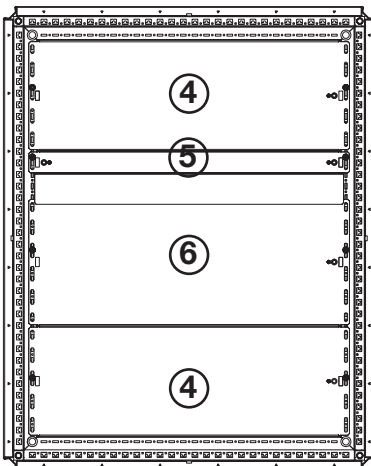

800 x 800

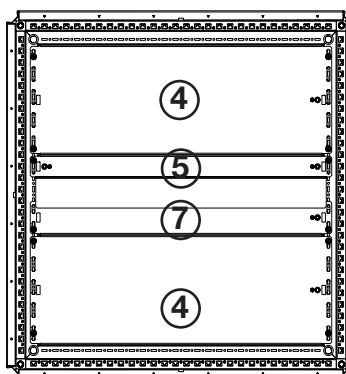

800 x 600

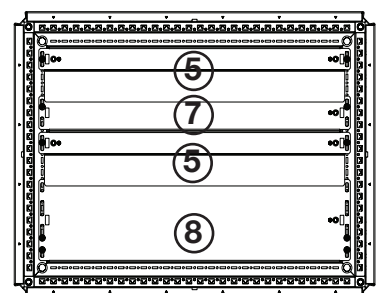

①	②	③	④	⑤	⑥	⑦	⑧
8001.218	8001.239	8001.222	8001.219	8001.241	8001.223	8001.211	8001.215
237,5 mm	schiebbar sliding mobile	275 mm	237,5 mm	schiebbar sliding mobile	275 mm	75 mm	175 mm

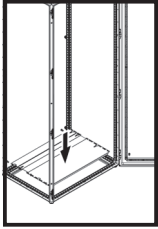

TX30



mm

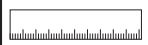

DE EN FR

4. Montage Bodenblech mehrteilig, geschlossen
4. Mounting the gland plate, multi-piece, solid
4. Montage de la plaque passe-câbles pleine en plusieurs parties

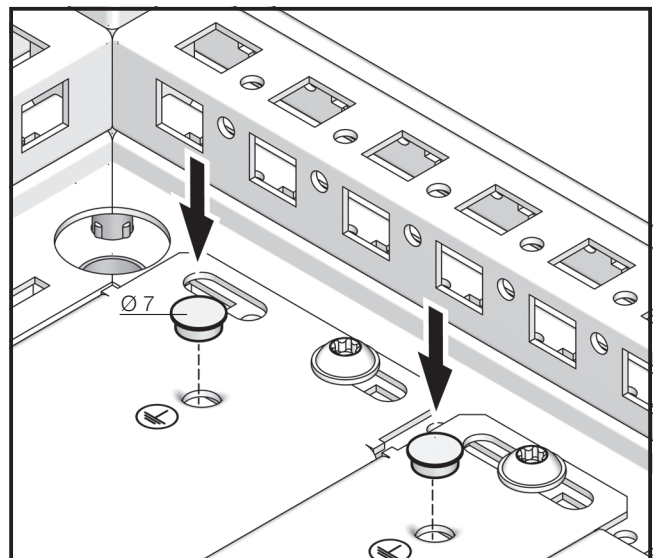
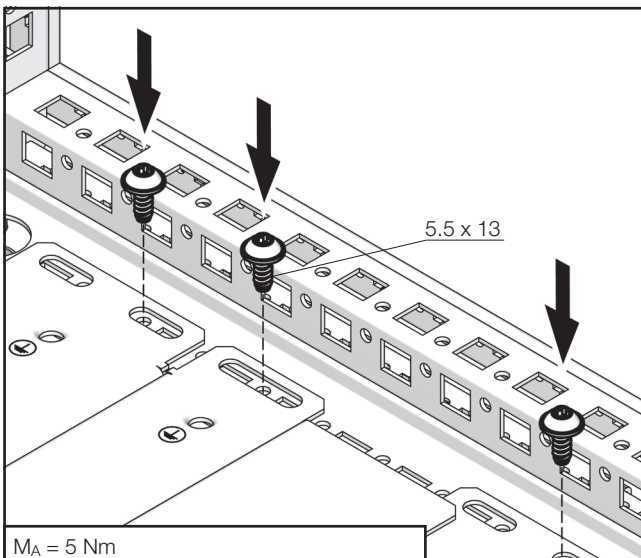
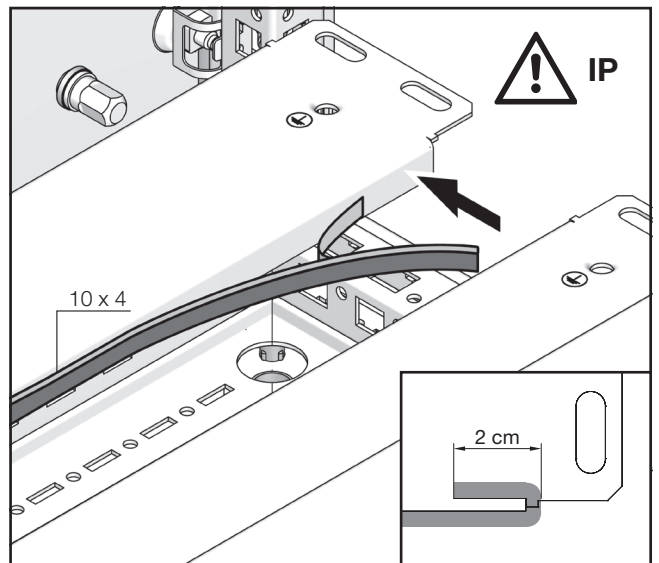
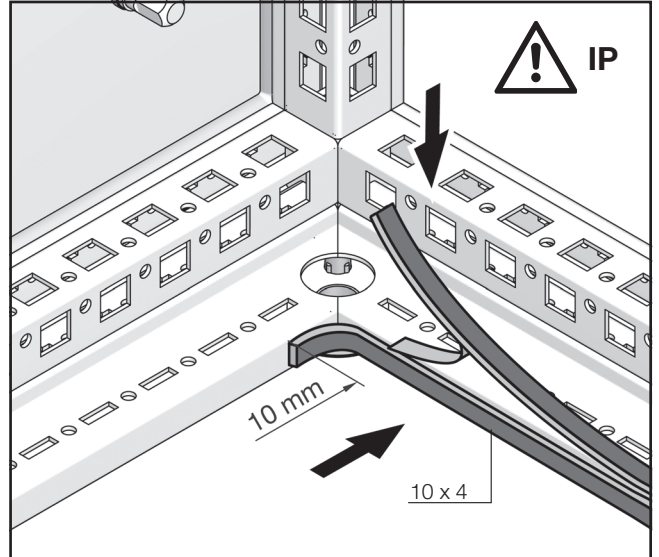
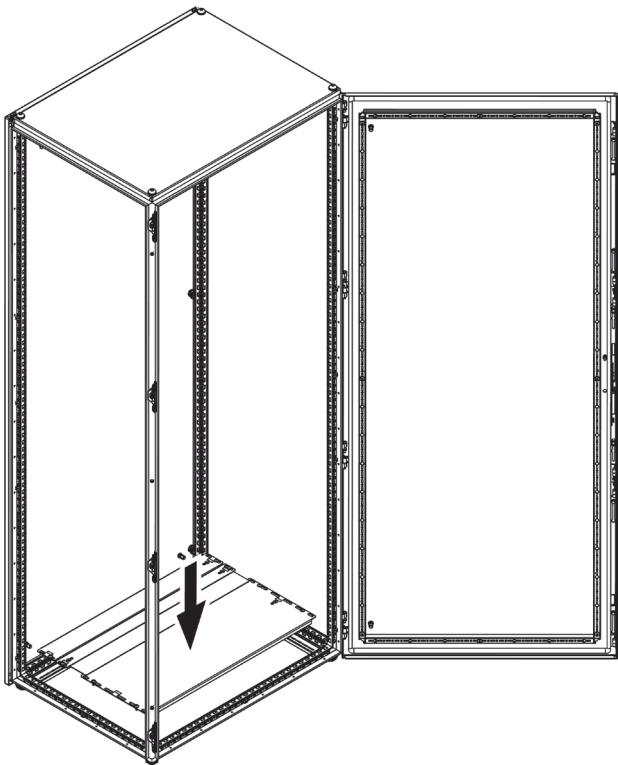

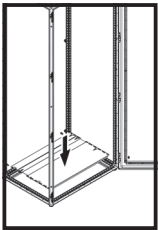

4. Montage Bodenblech mehrteilig, geschlossen
 4. Mounting the gland plate, multi-piece, solid
 4. Montage de la plaque passe-câbles pleine en plusieurs parties

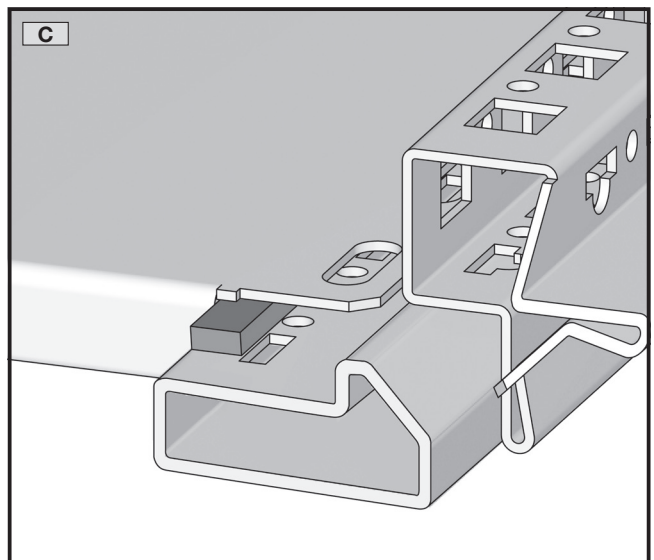
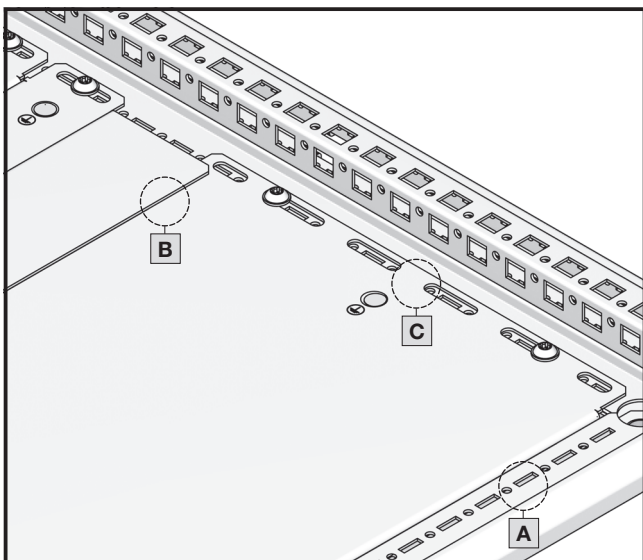
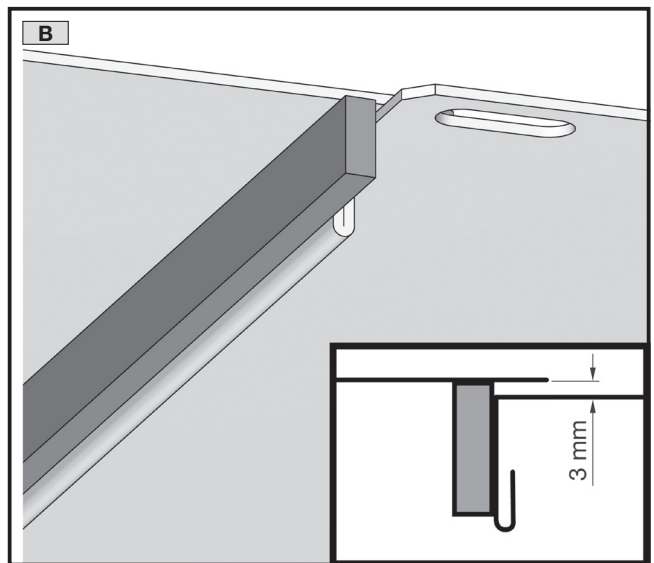
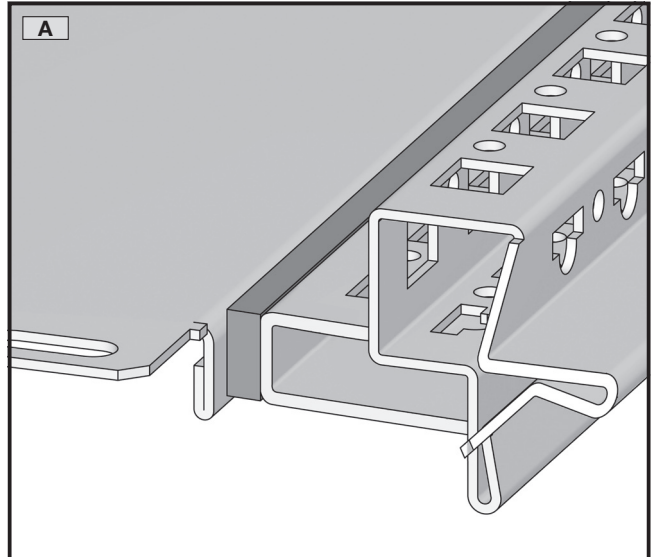
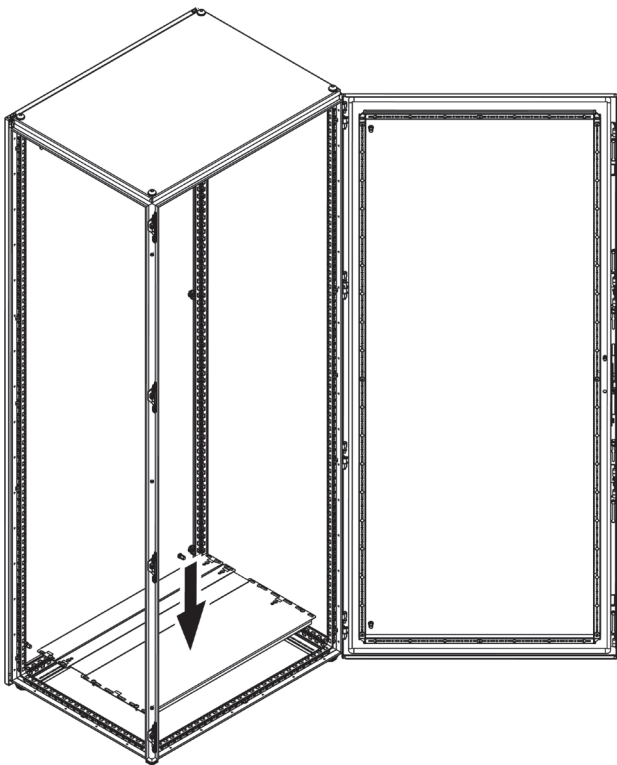

Notizen/Notes

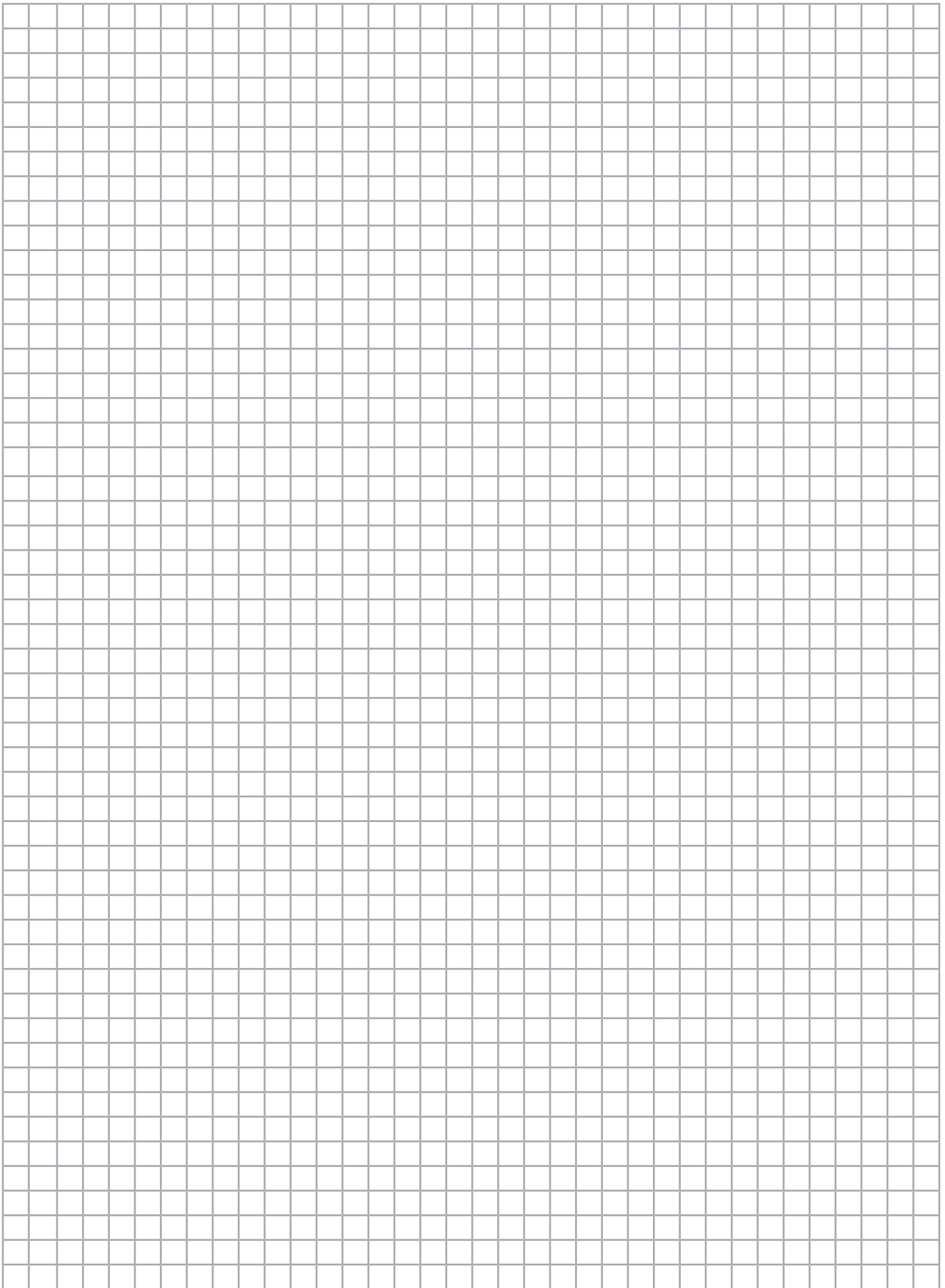

Notizen/Notes

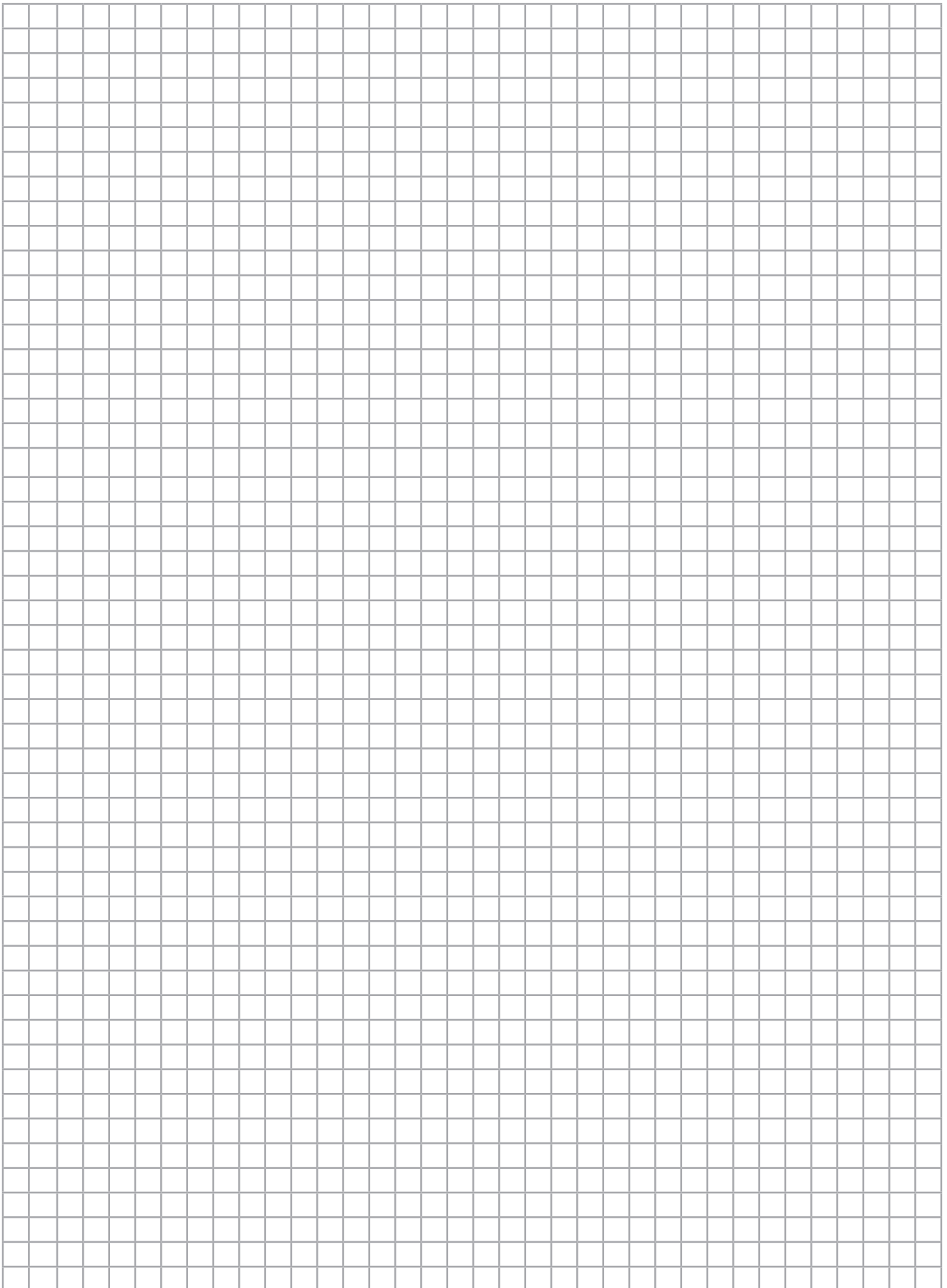

Notizen/Notes

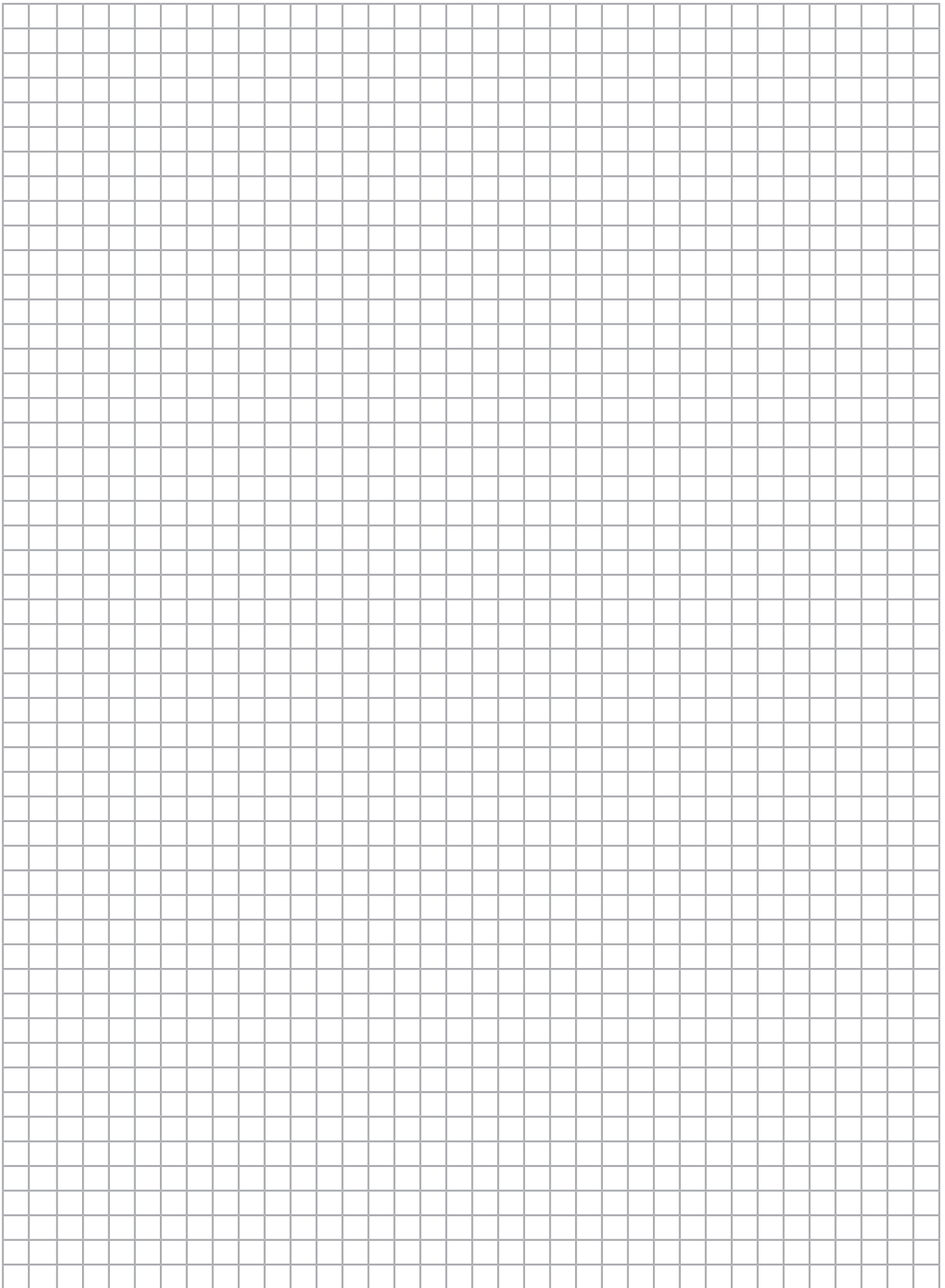

Rittal – The System.

Faster – better – everywhere.

- Enclosures
- Power Distribution
- Climate Control
- IT Infrastructure
- Software & Services

You can find the contact details of all Rittal companies throughout the world here.



www.rittal.com/contact

RITTAL GmbH & Co. KG
Auf dem Stuetzelberg · 35745 Herborn · Germany
Phone +49 2772 505-0
E-mail: info@rittal.de · www.rittal.com

12.2022/D-0000-00002286-04

ENCLOSURES

POWER DISTRIBUTION

CLIMATE CONTROL

IT INFRASTRUCTURE

SOFTWARE & SERVICES

FRIEDHELM LOH GROUP

