

Rittal – The System.

Faster – better – everywhere.



VX25 TopTherm chiller for cooling media

SK 3335930

SK 3335940

SK 3335950

SK 3335960

Assembly and operating instructions

ENCLOSURES

POWER DISTRIBUTION

CLIMATE CONTROL

IT INFRASTRUCTURE

SOFTWARE & SERVICES

FRIEDHELM LOH GROUP



Foreword

EN

Foreword

Dear Customer,

Thank you for choosing a "VX25 TopTherm chiller" (referred to hereafter as "chiller") from Rittal.

We wish you every success!

Yours,
Rittal GmbH & Co. KG

Rittal GmbH & Co. KG
Auf dem Stuetzelberg

35745 Herborn
Germany

Tel.: +49(0)2772 505-0
Fax: +49(0)2772 505-2319

E-mail: info@rittal.de
www.rittal.com

We are always happy to answer any technical questions regarding our entire range of products.

Contents

1	Notes on documentation	5	6.4	Commissioning procedure	18
1.1	General	5	6.5	Adjusting the bypass valve	18
1.2	CE conformity	5	7	Operation	18
1.3	Storing the documents	5	7.1	General	18
1.4	Symbols used in these operating instructions	5	7.2	Layout of the display	18
1.5	Other applicable documents	5	7.2.1	Start screen	18
2	Safety instructions	5	7.2.2	Changing a parameter value	20
2.1	General	5	7.3	Info menu	20
2.2	Risks in case of failure to observe the safety instructions	5	7.3.1	Temperature info	20
2.3	Safety instructions for assembly, inspection and maintenance work	5	7.3.2	Device info	21
2.4	Unauthorised operation	6	7.3.3	Information on I/O	21
2.5	Health risks due to the refrigerant R410A and the cooling medium	6	7.4	Configuration menu	21
2.6	First aid measures	6	7.4.1	On/Off	22
2.7	Fire-fighting measures	6	7.4.2	Temperature	22
2.8	Safety measures and equipment	6	7.4.3	Limit values of the temperature values	23
2.9	Potential hazards and how to avoid them	6	7.4.4	Language settings	23
3	Device description	7	7.5	System messages	24
3.1	General	7	7.5.1	Occurrence of a malfunction	24
3.2	General functional description	8	7.5.2	Display in case of errors	24
3.3	Control	9	8	Inspection and maintenance	25
3.4	Characteristic curves	9	8.1	Overview of the inspection and maintenance tasks	25
3.4.1	Characteristic curves of pump	9	8.2	Maintaining the refrigerant circuit	25
3.4.2	Performance diagrams	9	8.3	Monitoring the cooling medium	25
3.5	Safety devices	10	8.4	Cleaning the condenser	26
3.6	Intended use, foreseeable misuse	10	8.5	Cleaning the filter mat (accessories)	26
3.7	Scope of supply	10	8.6	Draining the cooling medium tank	27
4	Transport	11	9	Troubleshooting	27
4.1	Delivery	11	9.1	List of system messages	27
4.2	Unpacking	11	10	Decommissioning and disposal	32
4.3	Transport	11	10.1	Decommissioning	32
5	Assembly and connection	12	10.2	Disposal	32
5.1	Installation site requirements	12	11	Accessories	32
5.2	Installing the chiller	13	11.1	Metal filter (aluminium filter)	32
5.3	Making the hydraulic connection	13	11.2	Cooling medium for chillers (ready-mix)	32
5.4	Making electrical connection	13	11.3	Twin castors	33
5.4.1	Installing the power supply	14	11.4	Levelling feet	33
5.4.2	Connecting the alarm relay query device	14	11.5	Base/plinth corner piece with base/plinth trim panels, front and rear	33
5.4.3	External activation	14	11.6	Base/plinth trim panels, side, for base/plinth system VX, sheet steel	33
5.4.4	Room temperature sensor	14	11.7	Cross member	34
5.4.5	Interfaces	14	11.8	Comfort handle VX	34
5.5	Installing the filter mats (accessories)	15	11.9	Security lock insert, lock no. 3524 E	34
6	Commissioning	15	11.10	Push-button insert	34
6.1	Cooling medium water-glycol mixture	15	12	Appendix	35
6.1.1	General remarks	16	12.1	Block diagram	35
6.1.2	Cooling medium requirements	16	12.2	Hardware configuration	36
6.1.3	Preparation and care	16	12.2.1	Digital Inputs	36
6.1.4	Recommended "Cooling medium for chillers"	17	12.2.2	Analogue Inputs	36
6.2	Filling the cooling medium	17	12.2.3	Digital Outputs	36
6.3	Bleeding the cooling medium pump	17	12.2.4	Analogue Outputs	36
			12.3	Spare parts	37
			12.4	List of supervised variables	38

Contents

EN

12.5	Technical specifications	42
12.6	Device drawings.....	43
12.7	Declaration of Conformity.....	44

1 Notes on documentation

1.1 General

These instructions are aimed at installers and operators who are familiar with the installation and the operation of the chiller. It is very important to read and follow these assembly and operating instructions prior to commissioning. These are the original operating instructions.

1.2 CE conformity

Rittal GmbH & Co. KG confirms the conformity of the chiller with the European Union's Machinery Directive 2006/42/EC and EMC Directive 2014/30/EU. A corresponding declaration of conformity has been issued and enclosed with the unit.



1.3 Storing the documents

The assembly and operating instructions as well as all other applicable documents are an integral part of the product. They must be issued to everyone who works with the chiller and must always be available and on hand for operating and maintenance personnel.

1.4 Symbols used in these operating instructions

The following symbols are used in this documentation:



Danger!

A dangerous situation in which failure to comply with the instructions will result in death or severe injury.



Warning!

A dangerous situation which may cause death or serious injury if the instructions are not followed.



Caution!

A dangerous situation which may lead to (minor) injuries if the instructions are not followed.



Note:

Important notices and indication of situations which may result in material damage.

- This symbol indicates an "action point" and shows that you should perform an operation or procedure.

1.5 Other applicable documents

Assembly and operating instructions exist as paper documents and/or digital data carriers for the unit types described here and are enclosed with the equipment.

We cannot accept any liability for damage associated with failure to observe these instructions. Where applicable, the instructions for any accessories used also apply.

2 Safety instructions

2.1 General

Please observe the following general safety instructions when operating and installing the chiller:

- Assembly, installation and maintenance must only be carried out by qualified personnel.
- Children and persons with limited cognitive/coordination abilities must not operate, maintain or clean the unit or be allowed to use it as a toy.
- Only use original spare parts and accessories authorised by the manufacturer to ensure the protection and safety of the chiller. The usage of other parts will render any liability void.
- Do not make any changes to the chiller that have not been agreed with and approved by the manufacturer.
- It is also imperative that you observe the special safety instructions for the individual activities in the individual chapters.

2.2 Risks in case of failure to observe the safety instructions

In case of failure to observe the safety instructions, people, the environment and the chiller may be placed at risk. Failure to comply with the safety instructions makes all claims for compensation void.

2.3 Safety instructions for assembly, inspection and maintenance work

- The installation, commissioning and servicing of the chiller must be carried out in strict compliance with the technical documentation for the chiller and in such a way that no potentially hazardous situations are allowed to occur.
- Cleaning and maintenance work on the chiller must only be performed with the unit shut down. For this purpose, it is vital to ensure that the chiller is disconnected from the power supply and is secured against switching back on. It is imperative that you observe the procedure for shutting down the chiller described in the assembly and operating instructions.
- All safety devices and protective equipment must be reattached or put in a functional condition immediately after the work is complete.
- Modifications or changes to the chiller are not allowed.
- Only appropriately qualified personnel as defined by BGR500 chap. 2.35 / EN 378 are allowed to work on the refrigerant circuit.

2 Safety instructions

EN

- Do not install the chiller without protection outside of covered areas, or in an explosive or aggressive environment.
- Do not install the chiller on an unstable surface or a surface that is not designed for the weight of the chiller.
- Do not bypass any electrical safety devices to make it possible to operate the chiller.

2.4 Unauthorised operation

The safety of the chiller supplied is only ensured if it is used properly (see section 3.6 "Intended use, foreseeable misuse"). Under no circumstances should the limit values specified in the technical data be exceeded. The chiller is not allowed to be used for the direct cooling of liquids that are used for foodstuffs (e.g. drinking water).

Any existing contact hazard protection for moving parts must not be removed from chillers while operational. Hazards due to electrical power, do not remove any switch box cover!



Explosion hazard!

The use of the chiller for cooling inflammable or pyrophoric substances is prohibited.

2.5 Health risks due to the refrigerant R410A and the cooling medium

The refrigerant changes status during operation and becomes pressurised. The R410A safety data sheet must be observed.

The cooling medium (additive) is a liquid. We suggest: "Cooling medium for chillers" (see section 6.1 "Cooling medium water-glycol mixture"). The safety data sheet "Cooling medium for chillers" must be observed.

2.6 First aid measures

Please refer to safety data sheets R410A and "Cooling medium for chillers".



Note:

Safety data sheets are available for downloading at www.rittal.com.

2.7 Fire-fighting measures

Suitable extinguishing agent

All known extinguishing agents can be used.

2.8 Safety measures and equipment

- Ensure adequate ventilation.
- Hand protection: Safety gloves.
- Eye protection: Safety goggles.
- Body protection: Wear safety shoes when handling pressurised gas bottles.

2.9 Potential hazards and how to avoid them

The following table provides an overview of other potential sources of danger and how to avoid them.

Location	Hazard	Cause	Precautionary measures
Device interior	Severe personal injury or damage to property	Hazard due to electrical equipment of the chiller	Recurrent testing of electrical equipment (Germany BGV A3)
Device interior	Personal injury or damage to property	Electrical hazard while working on the chiller	The power to the chiller must be disconnected via the main switch.
Device interior	Inhalation of toxic gases/materials	Soldering work inside the chiller may release toxic gases due to the installed cooling circuit.	Maintenance may only be carried out by specialist personnel. Before carrying out soldering work on the cooling circuit or in its immediate vicinity, the refrigerant should be drained from the chiller.
Device interior	Risk for the product	Liquid level after transport not in upright position	Only transport the chiller upright. Should the chiller be tilted during transportation, please wait some minutes before switching on again.
Device interior: Micro-channel condenser	Minor cuts	Contact while cleaning the condenser (see section 8.4 "Cleaning the condenser")	Wear safety gloves.

Tab. 1: Hazards and precautionary measures

Location	Hazard	Cause	Precautionary measures
Device interior: Hot or cold parts	Burns / frostbite	Contact with parts with a high or low surface temperature.	The chiller may only be opened by trained, qualified personnel.
Device interior: Cooling medium circuit	Fungus and algae formation	Use of pure water as a cooling medium or refrigerant.	Use a water-glycol mixture as your cooling medium. Rittal recommends the use of "Cooling medium for chillers" (ready-mix).
Device exterior	Severe personal injury or damage to property	The floor on which the chiller is installed is unstable and unable to support its weight. The chiller tips over or the floor gives way.	The weight of the chiller can be found in section 12.5 "Technical specifications". Additionally, please allow for the weight of the liquid in the tank (the capacity of the tank can likewise be found in section 12.5 "Technical specifications") and make sure that the floor is suitable for installation purposes.
Device exterior	Personal injury or damage to property	Hazards when transporting or assembling the chiller	Secure the chiller against any risk of tilting (eyebolts) when transporting or assembling.
Device exterior	Cuts	Contact with fan wheel	Do not remove the protective cover around the fan wheel.
Device exterior: Area around the chiller	Major burns	Fire caused by short-circuiting or overheating of the electricity supply line to the chiller	When replacing, ensure that the cable cross-section and electricity supply line comply with the valid regulations.
Device exterior: Chiller with wheels	Personal injury or damage to property	The chiller starts to move due to unevenness of the floor surface.	If the recooling system is equipped with wheels (option), they must be locked with brakes while operational.

Tab. 1: Hazards and precautionary measures



Note:

Specialist personnel are individuals who, by virtue of their training, education, experience and knowledge of the relevant provisions, regulations and measures for accident prevention and relating to the operating conditions, have been authorised by the owner or responsible individual to ensure the safety of the system, carry out all essential tasks, and are therefore in a position to identify and avert all potential threats.

3 Device description

3.1 General

Chillers are used for the central and economical cooling and supply of a cooling medium (water + glycol, see section 6.1 "Cooling medium water-glycol mixture") in the event of physical separation between the place where cooling is required and the refrigeration. The cooling medium is supplied using a pipe system.

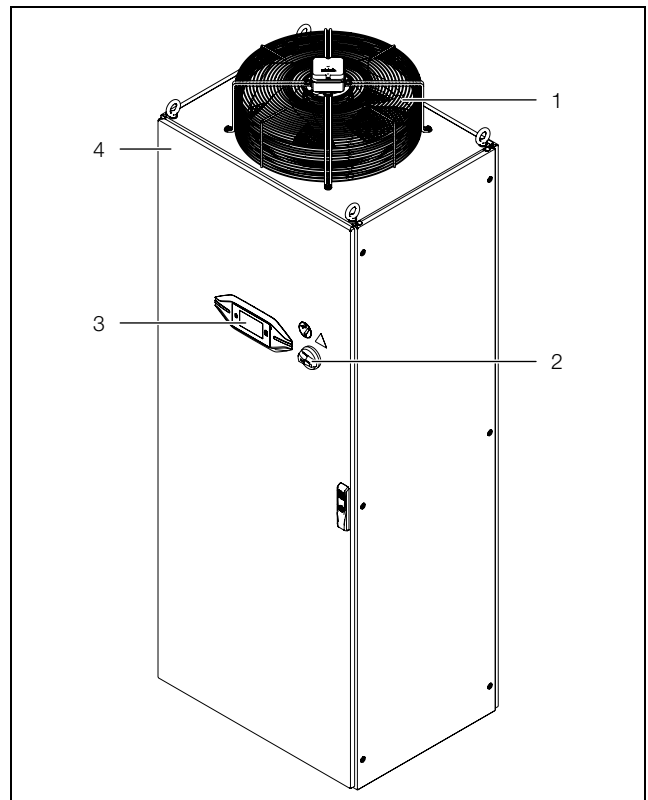

Fig. 1: View from front

3 Device description

EN

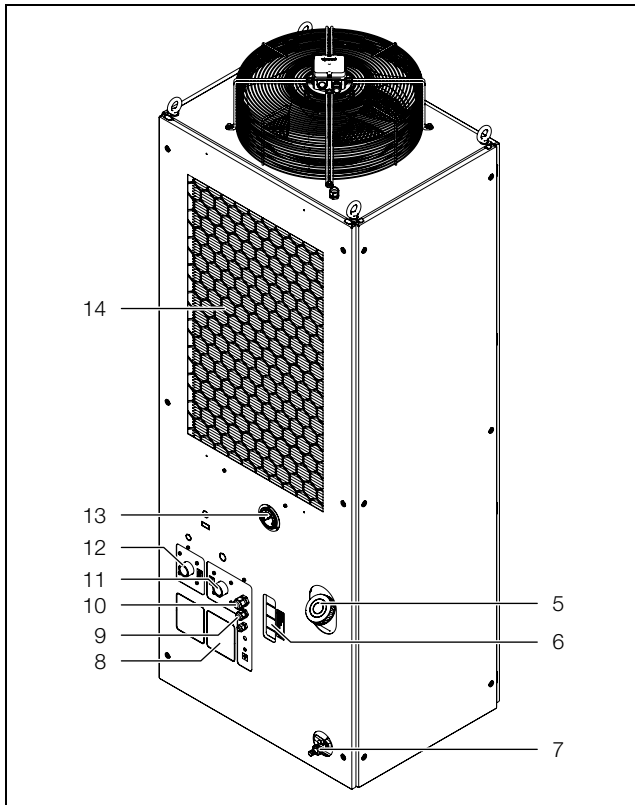

Fig. 2: View from rear

Key fig. 1 and fig. 2

- 1 Air outlet
- 2 Master switch
- 3 Display
- 4 Rating plate
- 5 Fill nozzle for cooling medium
- 6 Cooling medium level display (filling level indicator)
- 7 Tank drain nozzle
- 8 Cut-out for optional water cooled version
- 9 Electrical interfaces
- 10 Probe for room temperature control
- 11 Cooling medium connection, inlet
- 12 Cooling medium connection, outlet
- 13 Pressure gauge
- 14 Back panel for air inlet

The chiller is equipped with an open reservoir for the cooling medium.

3.2 General functional description

The chiller comprises four main components (see fig. 3):

- Evaporator coil (item 12),
- refrigerant compressor (item 13),
- condenser (item 1) with fan (item 2),
- control or expansion valve (item 4),

which are connected together by pipes. A high-pressure switch (item 14) limits the maximum pressure in the refrigerant circuit. The low-pressure switch switches off the refrigerant cycle in the event of low pressure. The R410A (50% R 32, 50% R125) refrigerant is chlorine-free. Its Ozone Depletion Potential (ODP) is 0.

A filter drier (item 3) which is integrated into the hermetically sealed refrigerant circuit provides effective protection against moisture, acid, dirt particles, and foreign bodies.

In the evaporator coil (item 12), the liquid refrigerant is converted to a gaseous state. The heat necessary for this purpose is taken from the cooling medium in the plate heat exchanger, which has the effect of cooling the cooling medium. The refrigerant is compressed in the compressor (item 13). As a result the refrigerant has a higher temperature than the ambient air.

This heat is dissipated to the ambient air over the surface of the condenser (item 1), resulting in the refrigerant liquefying again.

The refrigerant is injected into the evaporator (item 12) via an expansion valve (item 4), causing it to expand and as a consequence is able to absorb the heat from the cooling medium (water or water-glycol mixture).

The cooling medium is pumped to the equipment in an additional circuit via the cooling medium tank (item 10) and the cooling medium pump (item 9). Temperature monitoring of the evaporator coil (item 12) ensures protection against freezing if the flowrate is insufficient. The level switch (item 5) emits a warning if the level in the cooling medium tank is too low. The inlet temperature of the cooling medium (water or water-glycol mixture) is regulated using the temperature sensor (item 6) on the water outlet.

A layout drawing of the refrigerant circuit may be found in fig. 3.

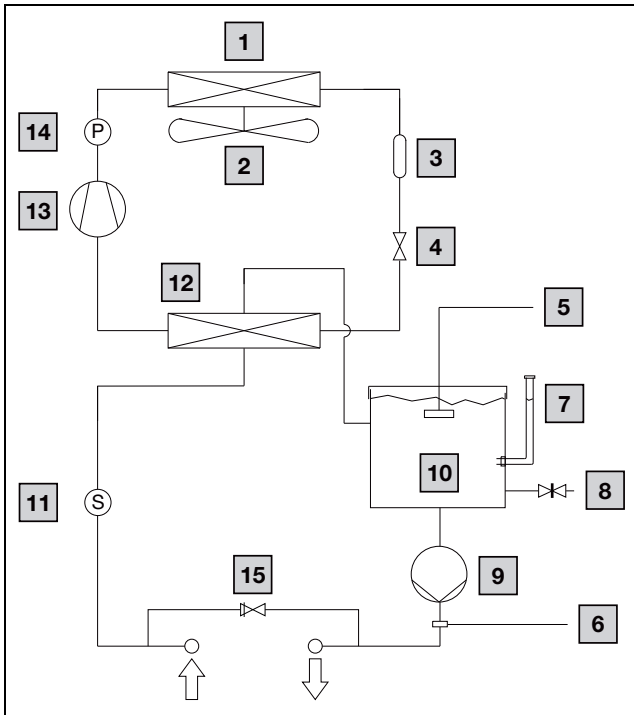

Fig. 3: Schematic diagram of refrigerant circuit (SK 33359x0)

Key

- 1 Condenser, air-cooled
- 2 Condenser fan (radial fan)
- 3 Filter dryer
- 4 Expansion valve
- 5 Fill level monitoring
- 6 Temperature sensor
- 7 Fill nozzle
- 8 Tank drain nozzle
- 9 Cooling medium pump
- 10 Cooling medium tank
- 11 Flow sensor
- 12 Evaporator (plate heat exchanger)
- 13 Compressor
- 14 Pressure-operated switch
- 15 Bypass valve

3.3 Control

The chillers are fitted with a controller for setting the functions of the chiller. Operation using this controller is described in section 7 "Operation".

3.4 Characteristic curves

3.4.1 Characteristic curves of pump

Characteristic curves measured under the following conditions:

- Ambient temperature (T_a) = 35 °C
- Medium temperature (T_w) = 18 °C
- Cooling medium "water"

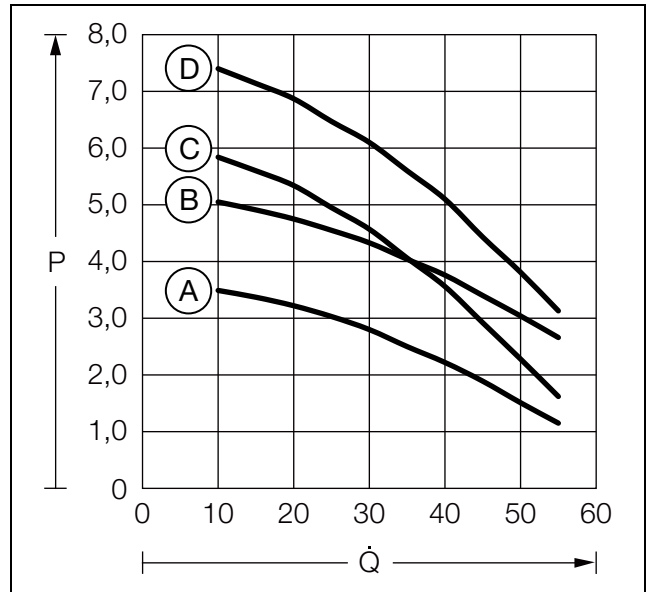

Fig. 4: Characteristic curves SK 3335930, SK 3335940 and SK 3335950

Key

- A Standard pump 50 Hz
- B Standard pump 60 Hz
- C Reinforced pump 50 Hz (option)
- D Reinforced pump 60 Hz (option)
- P External static pressure [bar]
- Q Delivery flow [l/min]

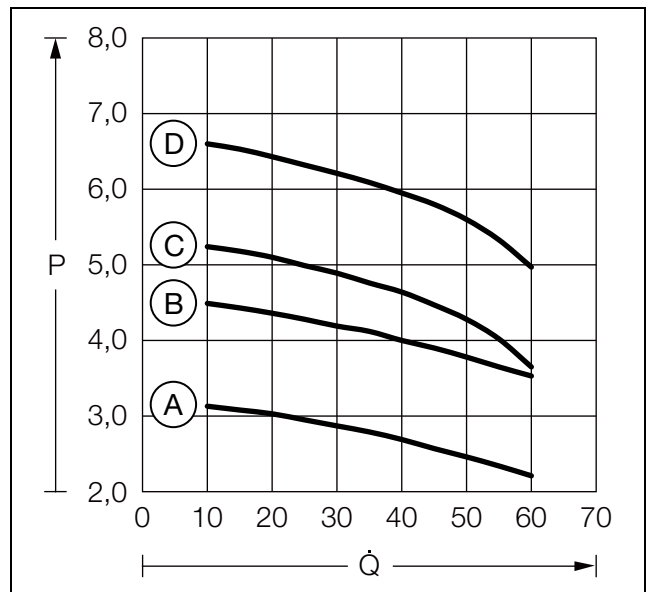

Fig. 5: Characteristic curves SK 3335960

Key

- A Standard pump 50 Hz
- B Standard pump 60 Hz
- C Reinforced pump 50 Hz (option)
- D Reinforced pump 60 Hz (option)
- P External static pressure [bar]
- Q Delivery flow [l/min]

3.4.2 Performance diagrams

The performance diagrams can be found on the Rittal website.

3 Device description

EN

3.5 Safety devices

- In the cooling circuit, the chiller has a type-tested pressure monitor (to EN 12263) which switches off the chiller if the maximum admissible pressure is exceeded. Once the pressure drops back below the admissible pressure, the unit will automatically resume operation.
- Temperature monitoring prevents the evaporator coil from icing over. The compressor will switch off completely and, at higher temperatures, the unit will automatically resume operation.
- The compressor motor, the fan motors and the cooling medium pump each have a motor circuit-breaker to prevent overcurrent and short-circuits.
- To ensure smooth-running and reliable operation (for example after reaching the setpoint temperature or after a fault), the compressor automatically switches back on after a delay.
- The chiller has two floating contacts, via which system messages from the device may be polled, e.g. using a PLC (2 x normally closed or normally open contacts).

3.6 Intended use, foreseeable misuse

The chiller is only used for cooling water-glycol mixtures. Any other use is deemed improper.

When using other fluids, please refer to the technical specifications in the appendix, or contact the manufacturer. Under no circumstances should the specified limits in the technical data be exceeded.

The chiller is state of the art and built according to recognised safety regulations. Nevertheless, improper use can pose a threat to the life and limb of the user or third parties, or result in possible damage to the system and other property.

Consequently, the chiller must only be used properly and in a technically sound condition! Any malfunctions which impair safety should be rectified immediately.

Intended use also includes the observance of the documentation provided and compliance with the inspection and maintenance conditions, and strictly professional use as defined in DIN EN 61000-3-2.

The unit must not be installed and operated in locations which are accessible to the general public.

Rittal GmbH & Co. KG is not liable for any damage which may result from failure to comply with the documentation provided. The same applies to failure to comply with the valid documentation for any accessories used.

Inappropriate use may be dangerous. Examples of inappropriate include:

- Use of the chiller for cooling flammable or combustible substances.
- The chiller must never be used for the direct cooling of liquids used in the food industry (e.g. drinking water).
- Use of impermissible tools.
- Improper operation.
- Improper rectification of malfunctions.
- Use of accessories not approved by Rittal GmbH & Co. KG.

3.7 Scope of supply

Qty.	Description
1	Chiller
1	Shipping bag with
1	- Assembly and operating instructions
1	- Connection cable (3 m), voltage supply
1	- Connection cable (3 m), signal exchange
4	- Eyebolts (already installed)

Tab. 2: Scope of supply

4 Transport

4.1 Delivery

The chiller is supplied in a packaging unit in a fully assembled state.

- Check the packaging carefully for signs of damage. Traces of oil on damaged packaging indicate a loss of refrigerant and/or a leak in the chiller. Any packaging damage may be the cause of a subsequent functional failure.

4.2 Unpacking

- Only transport the chiller in its original packaging material before commissioning for the first time.
- Remove the packaging materials from the chiller.



Note:

After unpacking, the packaging materials must be disposed of in an environmentally friendly way.

- Check the chiller for any damage that may have occurred during transport.



Note:

Damage and other faults, e.g. incomplete delivery, should be reported immediately, in writing, to the shipping company and to Rittal GmbH & Co. KG.

- Check the supply contents for completeness (see section 3.7 "Scope of supply").

4.3 Transport

If the chiller is stored or transported at temperatures below freezing, return to room temperature before commissioning.

- When transporting the chiller, please make allowance for the weight specified in section 12.5 "Technical specifications".
- Use lifting gear or a floor conveyor with a suitable maximum load capacity.
- If it is necessary to move the chiller in the factory, you must disconnect all connections on the chiller.
- Before transporting, empty the water circuit and tank (see section 8 "Inspection and maintenance").
- Prevent excessive vibration.
- Only transport the chiller upright.
- Transport the chiller
 - in packed state on the supplied pallet or
 - with lifting gear at the eyebolts provided for this purpose (fig. 6, item 1).

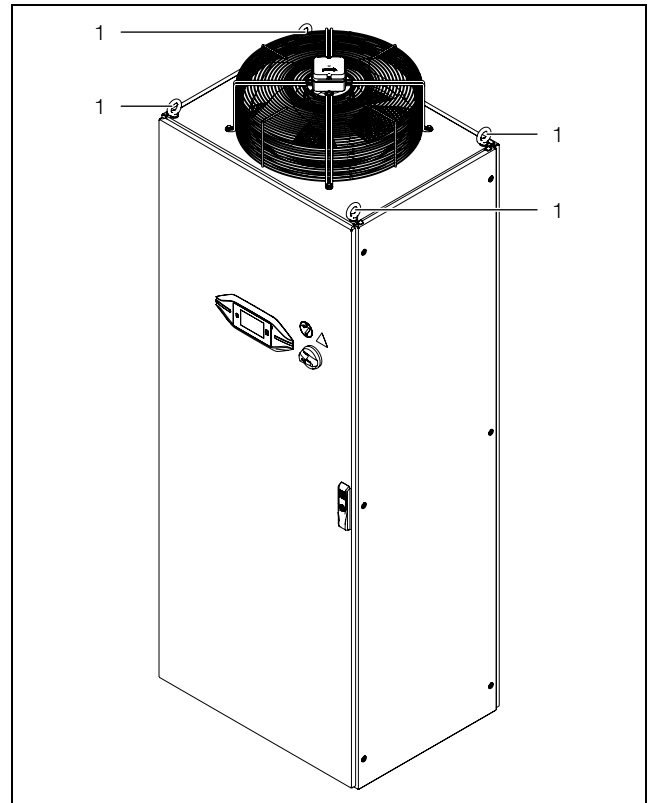

Fig. 6: Transport

Key

1 Eyebolts

- After transport, the eyebolts can be removed from the chiller.

5 Assembly and connection

EN

5 Assembly and connection

5.1 Installation site requirements



Note:

The device drawings including dimensions are shown in section 12.6 "Device drawings".

- The chiller must be adequately protected from external weather conditions.
- If the ambient air contains a high concentration of dust or oily substances, the chiller should be fitted with a metal filter (see section 11.1 "Metal filter (aluminium filter)").
- The supporting surface should be flat and sufficiently robust to hold the weight (see section 12.5 "Technical specifications") during operation.
- The ambient temperature must lie within the limit values indicated in the technical specifications (see section 12.5 "Technical specifications").
- In order to prevent performance losses caused by pressure drops in the pipework, the chiller should be sited as close as possible to the equipment.
- The opening on top of the chiller must be freely accessible to enable the unhindered expulsion of hot air (see fig. 7). To allow connection of the supply lines and facilitate maintenance and repair work, the minimum distances shown under fig. 7 should be adhered to.
- In order to avoid an "air short-circuit" (mixing of air intake and waste air) and ensure full cooling performance, the minimum distances shown under fig. 7 should likewise be adhered to.

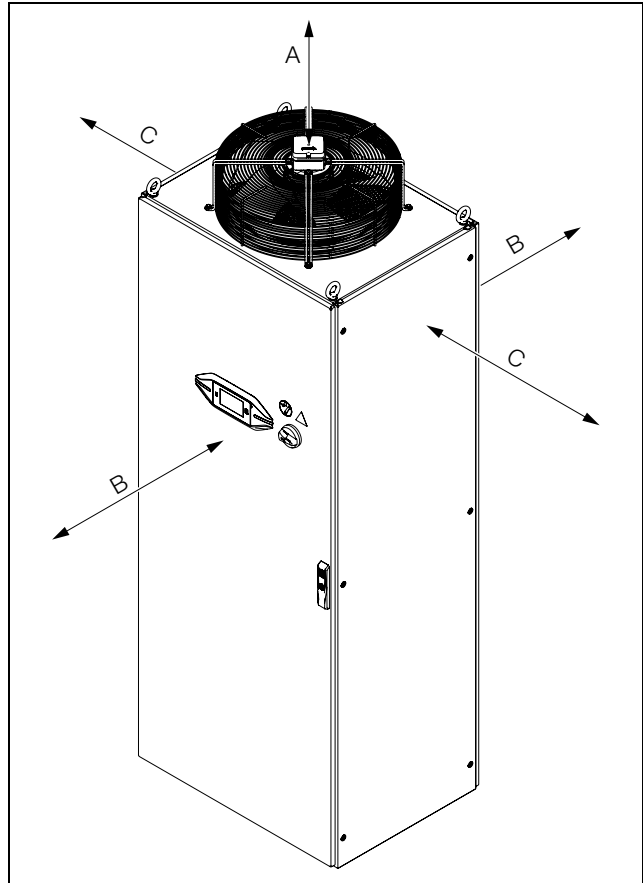

Fig. 7: Minimum distances

Side	Minimum distance [mm]	Reason
A (air outlet, top)	1000	Required distance for air outlet
B (front and rear)	800	Minimum distance for maintenance, connections and air inlet
C (sides)	0	No space required

Tab. 3: Minimum distances

- Ensure the room is adequately ventilated by installing the chiller such that the warm exhaust air does not heat the room excessively.
- In case of installation in a "small" room, it is imperative that you provide forced ventilation, as otherwise the heat dissipated will build up.



Caution!

The connection of an air intake / waste air duct is inadmissible.

- To prevent performance losses, do not install the chiller near any form of heating.

Size of installation room

Units must not be installed in rooms of less than 16 m³.

Siting

Chillers must be installed such that they cannot become damaged by internal traffic and transport operations.

5.2 Installing the chiller

- Install the chiller on an even, firm surface. The maximum permissible deviation from the vertical is 2°.
- Avoid the production of noise due to vibration (vibration dampers, sheets of foam rubber).

5.3 Making the hydraulic connection



Caution!

Risk of damage to the cooling medium pump due to soiling in the cooling medium circuit! Flush the cooling medium circuit prior to connecting the chiller.

The cooling medium outlet (fig. 2, item 12) on the chiller must be connected to the cooling medium inlet on the equipment to be cooled. At the same time, the cooling medium inlet (fig. 2, item 11) on the chiller must be connected to the cooling medium outlet on the equipment to be cooled. Please observe the following:

- To avoid condensation, always connect the equipment using insulated pipelines and/or hoses.
- The nominal width of the piping must correspond at least to the nominal width of the media connections on the chiller.
- The cooling medium infeed to the chiller must be pressureless, because the tank used in the system is open to the atmosphere.
- Never connect the chiller to the drinking water supply.
- The pipework must be approved for the maximum pressure expected (see section 12.5 "Technical specifications").
- The installation of two shut-off valves is recommended so that, for example, the chiller can be separated hydraulically for maintenance purposes.



Note:

The use of steel pipes or galvanised steel pipes is inadmissible.

Prior to commissioning, it is imperative that the cooling medium pump is filled with cooling medium and bled (see section 6.3 "Bleeding the cooling medium pump").



Caution!

An insufficient flow rate will trigger the safety devices in the chiller. Pay attention to the minimum pressure required and the minimum flow rate required (see section 12.5 "Technical specifications").

If the cooler on the equipment to be cooled is higher than the chiller, we recommend installing a non-return valve in the feed as well as a solenoid valve in the cooling medium circuit return to prevent the tank from overflowing.

A bypass valve should be connected between the inlet and return to protect the cooling medium pump. This opens automatically, for example, if the equipment cycle is shut off. The valve is preset for the associated deployed cooling medium pump and operation with 50 Hz. If the chiller is operated with 60 Hz, the valve setting can be adjusted.

5.4 Making electrical connection

- When carrying out the electrical installation, observe all applicable national and regional regulations as well as the regulations from the responsible utility company.
- Electrical installation must only be carried out by a qualified electrician who is responsible for compliance with the existing standards and regulations.

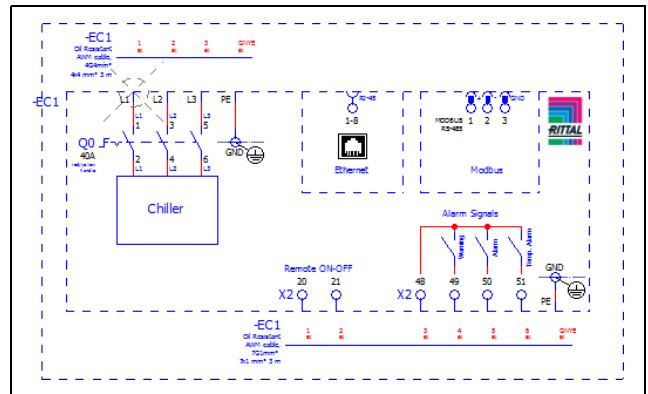

Fig. 8: Circuit diagram

Connection data

- The connected voltage and frequency must correspond to the values stated on the rating plate.
- If the chiller should be operated with a different connection voltage and frequency, the transformer wiring must be changed.
- The chiller must be connected to the mains via an all-pole isolating device.
- If a motor circuit-breaker or circuit-breaker is used, it should be selected in accordance with EN 60898-1 (tripping characteristic type D).
- To ensure the proper functioning of internal pressure sensors in the event of a malfunction, a slow (time delay) line fuse of no less than 15 A is required.
- Low-noise potential equalisation must be guaranteed with the mains connection. As a general principle, the chiller must be integrated into the building's potential equalisation system.
- The connection must be made with the field rotating clockwise. The direction of rotation of the field can be measured at the connection terminals L1, L2 and L3. Connect with a clockwise rotating field to ensure that the cooling medium pump motor rotates in the correct direction.

5 Assembly and connection

EN

Electrical connection with 460 V / 60 Hz

If your chiller uses an auxiliary supply of 24 V AC and you wish to operate your chiller at 460 V/3~/60 Hz, it is necessary to rewire the transformer. This transformer assignment must be carried out by an authorised, trained member of staff prior to installation, observing all safety requirements.

In its delivered state, the transformer is defined to a supply voltage of 400 V.

- Disconnect this connection and reassign it to 460 V (fig. 9).



Fig. 9: Transformer connection

Overvoltage protection and supply line load

- The chiller does not have its own overvoltage protection. Measures must be taken by the operator at the supply end to ensure effective lightning and overvoltage protection.
- The mains voltage must not deviate by more than the tolerance specified in section 12.5 "Technical specifications".
- The chiller and its power electronics are designed in accordance with overvoltage category III. If the combined output of the frequency converters, power converters or transformers in the network where the device is being operated is >70 kVA, the customer must connect a Class II surge voltage protector in the mains supply line upstream of the chiller. The surge voltage protector must be designed to EN 61800 -1. The following values may be assumed as starting-points for the design:

Transformers, power electronics	Assumed discharge energy
70 kVA...100 kVA	40 J
100 kVA...200 kVA	80 J
200 kVA...400 kVA	160 J
400 kVA...800 kVA	320 J

Tab. 4: Design of the surge voltage protector

Interfaces

To evaluate fault messages of the chiller via the alarm relay, an appropriate signal cable is connected at the rear of the chiller (see section 5.4.2 "Connecting the alarm relay query device").

If you require remote activation of the chiller, this can also be achieved via this signal cable.

5.4.1 Installing the power supply

The units are prewired ready for connection in the factory and equipped with a connection cable (length 3 m).

- Establish the mains supply in accordance with the associated connection identification and the circuit diagram using the connection cable at the rear of the chiller.

Strain relief

- Please provide suitable strain relief for the connection cable.

5.4.2 Connecting the alarm relay query device

System messages from the cooling unit may be output to an external signal source via two floating relay outputs. For this purpose, an appropriate cable is already connected at the rear of the chiller.



Caution!

If you are using external activation, the bridge implemented in the factory must be removed.

- Connect the correspondingly labelled wires of the connection cable to the controller in accordance with the circuit diagram.

5.4.3 External activation

The chiller has been prepared for control via an external signal.

- Connect a floating contact to contacts 1 and 2 of the signal cable.

This function is deactivated by default, i.e. the chiller is permanently in operational mode. With the function activated and the contact open, the cooling function and, where applicable, the cooling medium pump are switched off.

5.4.4 Room temperature sensor

The chiller allows for room-temperature-based control. For this purpose, an appropriate room temperature sensor is connected at the rear of the chiller.

- Configure the chiller control mode so that the temperature is regulated by the sensor measurement (see section 7.4.1 "On/Off").

5.4.5 Interfaces

The chiller is equipped with the following interfaces for communicating with external systems – ideal for BYOD (Bring Your Own Device)

- RS485 Modbus interface (on the board)
- Ethernetcard interface (on the board)

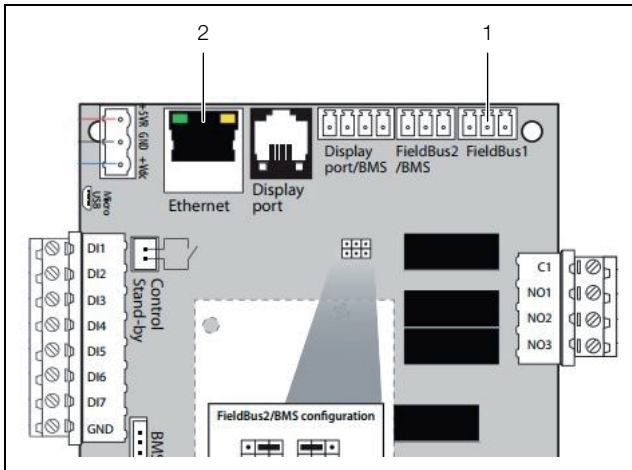

Fig. 10: Connectors

Legend

- 1 "FieldBus1" connector
- 2 "Ethernet" connector

RS485 Modbus Interface

- On the board use the "FieldBus1" connector (fig. 10, item 1) to connect the appliance to a monitoring device.

Ethernetcard Interface

- On the board use the "Ethernet" connector (fig. 10, item 2) to connect the appliance to a monitoring device via web pages.



Note:

- See the manual "Ethernetcard Interface" on the website.

5.5 Installing the filter mats (accessories)

For ambient air containing oil, we recommend installing metal filters in the chiller (see section 11.1 "Metal filter (aluminium filter)"). These may be cleaned with suitable detergents and reused (see section 8.5 "Cleaning the filter mat (accessories)").

- Mount the two holders (fig. 11, item 3) with the mounting screws (fig. 11, item 1) on the back of the chiller.

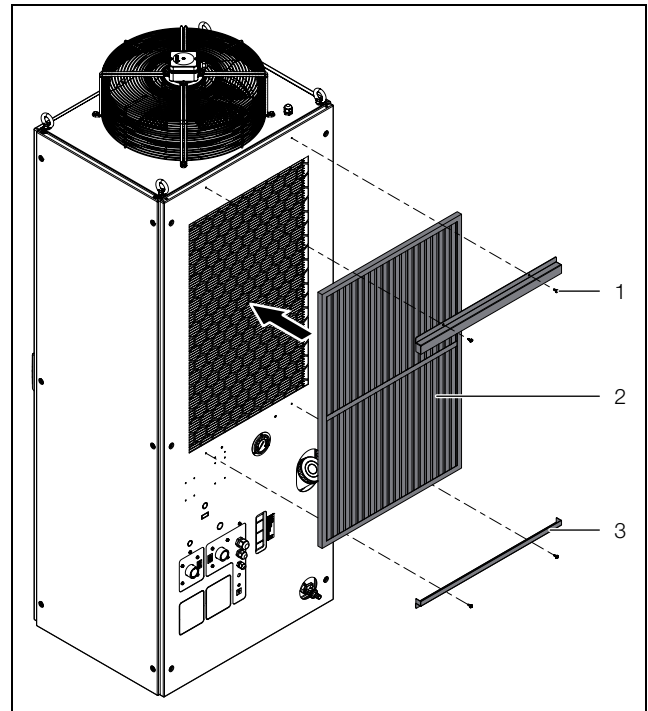

Fig. 11: Installing the metal filters

Key

- 1 Mounting screws (4x)
- 2 Filter mat
- 3 Holders (2x)

- Insert the metal filter between the two holders.
- If necessary, use a tool, such as a screwdriver, to press the filter into the holders.

6 Commissioning

The chiller has a master switch allowing it to be switched off for maintenance work.

In day-to-day operation, it should be switched on and off by the higher-level controller.

6.1 Cooling medium water-glycol mixture

As standard, the chiller is not suitable for operation below the specified minimum temperature (see section 12.5 "Technical specifications").

Generally speaking, a water-glycol mixture with a maximum glycol proportion of between 20 and 34% by volume should be used as the cooling medium. We recommend our ready-mixed "Cooling medium for chillers" (see section 6.1.4 "Recommended "Cooling medium for chillers)"). Other water-glycol mixtures may be possible in individual cases, but only in consultation with the manufacturer.



Caution!

Other additives may damage the pipes and the seal on the cooling medium pump, and are therefore only admissible by arrangement with Rittal.

6 Commissioning

EN



Note:
With the chiller sited outdoors ("Outdoor" option), it is important to adjust the glycol proportion accordingly.

6.1.1 General remarks

When cooling the water-glycol mixture in an open circuit, always remember that algae, deposits and corrosion can damage the chiller. Residues will always impair the performance of the chiller. Without water treatment it is only seldom possible to achieve satisfactory conditions. By means of regular monitoring of the quality of the cooling medium and cooling medium treatment, you must ensure that deposits and corrosion are avoided, even under extreme conditions.

6.1.2 Cooling medium requirements

The cooling medium must not cause any limescale deposits or loose debris. In other words, it should have a low level of hardness, particularly a low level of calcium hardness. In particular, the level of calcium hardness should not be too high when using the equipment for recirculated cooling. On the other hand, the cooling medium should not be so soft that it attacks the materials. When recooling the cooling medium, the salt content should not be allowed to increase excessively due to the evaporation of large quantities of water, since the electrical conductivity will increase as the concentration of dissolved substances rises, and the cooling medium will become more corrosive. For this reason, not only is it always necessary to add a corresponding quantity of fresh water, but also to remove part of the enriched cooling medium.

Furthermore, the properties of the water used must not deviate from the following list of hydrological data:

Properties	Value
pH value	(7) 7.5 – 8.5
Electrical conductivity	200 – 1000 µS/cm
Residue on evaporation	< 500 mg/dm ³
Sedimentary substances	< 3 mg/dm ³
Hardness	3 – 8°dH (for German-speaking regions)
Ca + Mg	0.5 – 2 mmol/l (for international region)
Hydrogen carbonate	1 – 5 mmol/dm ³ (60 – 300 mg/dm ³)
Free CO ₂	< 10 mg/dm ³
Sulphide	< 0.01 mg/dm ³
Chloride	< 50 mg/dm ³

Tab. 5: Hydrological data

Properties	Value
Sulphate	< 250 mg/dm ³
Nitrate	< 25 mg/dm ³
Nitrite	< 0.1 mg/m ³
COD	< 7 mg/dm ³
NH ₄	< 0.05 mg/dm ³
Fe	< 0.1 mg/dm ³
Mn	< 0.1 mg/dm ³
Cu	< 0.1 mg/dm ³

Tab. 5: Hydrological data



Note:
The cooling medium thickens due to evaporation. You can return the values to within the usual ranges by completely replacing the cooling medium (see section 8.3 "Monitoring the cooling medium").
Only use distilled or de-ionised water in chillers specified for such use (see data sheet in section 12.5 "Technical specifications").

6.1.3 Preparation and care

There are specific cooling medium requirements depending on the type of equipment being cooled. A suitable process must then be used to prepare and/or maintain the cooling medium to suit the level of contamination and the size and design of the chiller. The most common types of contamination and most frequently used techniques to eliminate them in industrial cooling are shown in the following table:

Type of impurity	Removal
Mechanical contamination	Filtering of the cooling medium via mesh filter, gravel filter, cartridge filter, or pre-coated filter
Excessive hardness:	Softening of the cooling medium using ion exchange
Moderate content of mechanical contaminants and hardeners	Addition of stabilisers and/or dispersing agents to the water
Moderate levels of chemical contaminants	Addition of passifiers and/or inhibitors to the cooling medium
Biological contaminants, slime bacteria and algae	Addition of biocides to the cooling medium

Tab. 6: Impurities and removal

6.1.4 Recommended "Cooling medium for chillers"

Rittal recommends the use of "Cooling medium for chillers" (water-glycol mixture). This is a ready-mixed solution and is therefore suitable for immediate use (without the need for mixing) (tab. 7).

Composition

Glycol (20-33% max.) + water (67-80% max.) = ready-mix ("Cooling medium for chillers")

Model No.	Quantity [l]	Application
3301950	10	Outdoor
3301960	10	Indoor
3301955	25	Outdoor
3301965	25	Indoor
3301957	200	Outdoor
3301967	200	Indoor

Tab. 7: Model numbers – Cooling medium for chillers



Note:

When glycol is used, the cooling performance is reduced, depending on the glycol concentration (tab. 8).

Cooling medium for chillers	Temp. [°C]	Loss of cooling performance compared with pure water [%]
Standard (20% glycol) Antifreeze: -10 °C	10	-6
	15	-6
	18	-6
Outdoor (33% glycol) Antifreeze: -20 °C	10	-13
	15	-13
	18	-13

Tab. 8: Performance loss

To prevent problems in the cooling medium circuit (including water-cooled chillers), it is imperative that the VGB Cooling Water Guidelines (VGB-R 455 P) are observed.

The correct glycol concentration proportions may be read and determined using a refractometer.

6.2 Filling the cooling medium

The composition of the cooling medium is described in section 6.1 "Cooling medium water-glycol mixture".

For commissioning, proceed as follows:

- Ensure that any shut-off valves installed in the cooling medium circuit are open.

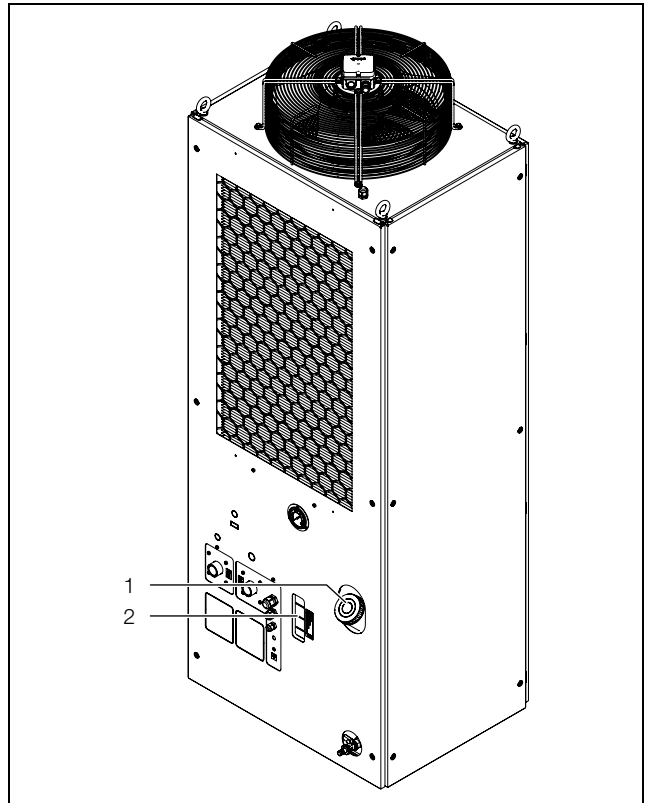

Fig. 12: Filling the cooling medium

Key

- 1 Fill nozzle for cooling medium
- 2 Cooling medium level display (filling level indicator)

- Fill the chiller tank with cooling medium via the fill nozzle (fig. 12, item 1).

- Check the filling level on the container through the opening in the casing (fig. 12, item 2).

If the "Low filling level" warning appears, top up with the following quantity of cooling medium:

– approx. 75 l

If the tank is over-filled, or if a leak occurs, the cooling medium will run off via a hole in the centre of the gland plate.



Note:

Glycol poses a threat to groundwater. The plant operator is obliged to observe the relevant requirements on groundwater protection in his country.

6.3 Bleeding the cooling medium pump

- Bleed the pipes and top-up the cooling medium (see section 6.2 "Filling the cooling medium").

- Bleed the cooling medium pump (with the system at a standstill) by loosening the vent screw (fig. 13, item 1). As soon as cooling medium escapes from the vent screw, bleeding of the pump is complete.

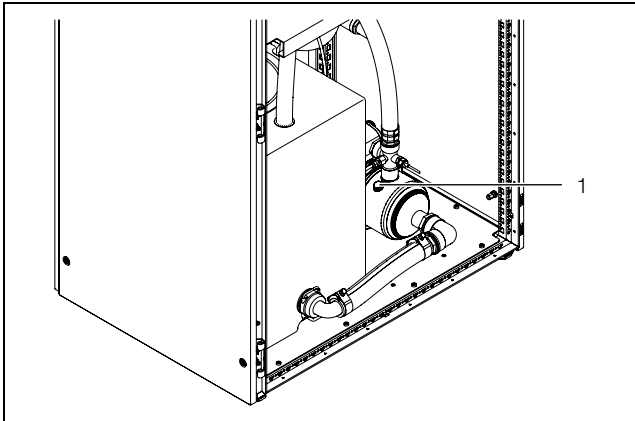

Fig. 13: Bleeding the cooling medium pump

Key

1 Vent screw

- Re-tighten the vent screw.
- Check the connection lines and pipe connections for leaks during commissioning.

6.4 Commissioning procedure

- Before switching on the motor for the first time, or if the position of the display showing the direction of rotation has been altered, check whether the display is working correctly, e.g. by moving the display panel with your finger.
- Switch on the power supply to the chiller via the superordinate controller.
- Switch the master switch into the "I" position. The Rittal logo will initially appear on the display, followed a short time later by the start screen.



Note:

If the compressor does not start up, the temperature of the coolant added is lower than the setpoint temperature.

- If necessary, lower the setpoint temperature momentarily (see section 7.2.2 "Changing a parameter value").

The cooling air is drawn in from the side and expelled at the top.

If required, the condenser fan is activated by the temperature controller.

6.5 Adjusting the bypass valve

A bypass valve should be connected between the inlet and return to protect the cooling medium pump. This opens automatically, for example, if the equipment cycle is shut off. The bypass valve must be adjusted to suit the requirements of the customer's application.

- Dismantle the side panel of the chiller and place it somewhere safe.
- Open the bypass valve by rotating in a counter-clockwise direction.

- Vent the cooling medium pump (see section 6.3 "Bleeding the cooling medium pump") and switch it on.
- Shut off the water flow to the customer application completely using a customer-supplied shut-off valve in the pipeline or in the end application.
- Adjust the bypass valve so that a pressure appropriate for the variant and the operating voltage in accordance with the following table is displayed on the manometer at the rear of the chiller.

Model No.	Display pressure in bar for frequency	
	50 Hz	60 Hz
SK 3335930	3.4	4.7
SK 3335940	3.4	4.7
SK 3335950	3.4	4.7
SK 3335960	2.8	4.2

Tab. 9: Bypass valve setting

- Reopen the water flow to the customer application.
- Reinstall the side panel on the chiller.

7 Operation

7.1 General

The chiller is switched on and off by the higher-level control. It operates automatically, i.e. the cooling medium is pumped continuously and heat extracted from it during this process.

The compressor has a switch-on delay after being switched on or after a fault. If there is a sudden cooling load demand, therefore, cooling medium temperatures may be increased during the startup process.

The chiller is equipped with a touch function display for making basic settings and displaying error messages. This is an industrial-grade touch display which is pressure-sensitive and may therefore be operated with gloves.

7.2 Layout of the display

The display is divided into a top section on a dark background, and a bottom section with the menu bar. This layout is always identical, but the content of the two sections will vary according to the menu selected.

7.2.1 Start screen

The start screen is always displayed while the cooling unit is in normal operation, provided there are no error messages.



Fig. 14: Layout of the start screen

Key

Item	Description	Possible symbols
1	Current medium temperature (3-digit °C, 4-digit °F)	Numbers from 0-9
2	Ambient temperature (outdoor temperature)	
3	Adjustment temperature (medium temperature)	
4	Display temperature unit	°C °F
5	USB connection (if connected)	
6	Self-test (function not active)	
7	NFC connection (function not active)	
8	Chiller on/off	
9	Control based on a room sensor or an internal sensor	
10	Pumps on	

Tab. 10: List of all symbols with descriptions

Item	Description	Possible symbols
11	Compressors on	
	Pre-heating heater	
12	Hot gas bypass	
13	3-way valve (circuit 2)	
14	Ventilation on	
	Water condensation	
15	Ventilation on (if double circuit)	
16	Info menu	
17	System messages (where applicable)	
18	Service symbol (if required)	
19	Configuration	

Tab. 10: List of all symbols with descriptions

On - off mode

The chiller can be switched on or off in standby mode in 2 ways:

- Press the centre of the main screen for at least 3 sec.
- Release the screen.
The on/off screen will appear with the chiller status symbol.
- Press on the symbol to change the operating status.

7 Operation

After the change, the home screen automatically reappears.

Symbol	Parameter
	Chiller is on.
	Chiller is off.

Tab. 11: Possible symbols when being switched on and off

Alternatively, the chiller can also be switched on or off via the configuration menu (see section 7.4 "Configuration menu").

- On the start screen, click on the "Configuration" button.
- Enter the PIN to gain access to the lower-level screen pages of the "Configuration" zone. "22" is the default PIN.
- Press the "On/Off" symbol to switch the chiller on or off.
- Exit this screen page with the "Back" button.

7.2.2 Changing a parameter value

If a parameter value is changed, the display including the menu bar will also change.



Fig. 15: Screen for changing a parameter value

Key

- 1 Main screen
- 2 Control bar

The currently selected parameter value is displayed in the centre of the main screen. To change this value, you always proceed in the same way, as described below with the example of adjusting the set temperature:

- On the start screen, click on the "Configuration" button.
- Enter the PIN to gain access to the lower-level screen pages of the "Configuration" zone. "22" is the default PIN.
- Click on the "Temperature" symbol.
- Click on the "Type of adjustment" symbol.
- Select the desired type of adjustment on the display.

- Change the setting to the required temperature using the "Up" and "Down" arrows.
- Finally, confirm the set value with "OK".
- Exit this screen page with the "Back" button.

7.3 Info menu

- Click on the "Info" symbol to display a list of lower-level screen pages.

Symbol	Parameter
	Temperature info
	Device info
	Information on the appliance I/O

Tab. 12: "Info" zone

7.3.1 Temperature info

- Click on the "Temperature info" symbol. A list of different temperature values will be displayed.
- Page through the list using the "Up" and "Down" arrows.

Symbol	Parameter
	Current setpoint Current setpoint for circuit 1.
	Av. medium 24h Average medium temperature over the last 24 hours of operation.
	Av. ambient 24h Average ambient temperature (external temperature) over the last 24 hours of operation.
	Current setpoint Current setpoint for circuit 2 (if any).
	Current setpoint Current setpoint for exchanger circuit A.

Tab. 13: "Temperature info" zone

Symbol	Parameter
	Current setpoint Current setpoint for exchanger circuit B.









Tab. 13: "Temperature info" zone

7.3.2 Device info





- Click on the "Device info" symbol.

A list of general information about the device will be displayed.

- Page through the list using the "Up" and "Down" arrows.

Symbol	Parameter
	Article number
	Serial number
	Manufacture date YYYY-MM-DD
	Hardware release x.xx.xx
	Firmware release x.xx.xx
	Software touch version x.xx.xx Software µPC3 version x.xx.xx
	Last update YYYY-MM-DD
	Last maintenance YYYY-MM-DD
	User device name Name assigned to the cooling unit by the customer.

Tab. 14: "Device info" zone





Symbol	Parameter
	Current adjustment mode (circuit 1)
	Current adjustment mode (circuit 2)
	Current adjustment mode (exchanger circuit A)
	Current adjustment mode (exchanger circuit B)
	Cooling Capacity (viewable only if the inlet probe and the cooling capacity are enabled in the Manufacturer's Menu Parameters).

Tab. 14: "Device info" zone

7.3.3 Information on I/O

- Click on the "Info I/O" symbol.

It displays a list with the information and status related to all chiller inputs and outputs divided into the following sub-menus.

Symbol	Parameter
	Values of analogue inputs
	Values of analogue outputs
	Status of digital inputs
	Status of digital outputs

Tab. 15: "Info I/O" zone

7.4 Configuration menu

- Click on the "Configuration" symbol.

A screen page will appear asking you to enter the PIN in order to access the lower-level screen pages.







Note:

"22" is preset in the factory as the default PIN.

7 Operation

- For the first digit, page through the digits "0" to "9" using the "Up" and "Down" arrows until the required digit appears in the box.
 - Confirm your selection with "OK".
 - For the second digit, once again page through the digits "0" to "9" using the "Up" and "Down" arrows until the required digit appears in the box.
 - Confirm your selection with "OK".
- A list of lower-level screen pages will be displayed.

Symbol	Parameter
	On/Off Device Switch-on and Switch-off
	Temperature Nominal temperature and adjustment type settings.
	Display language Choice of language for display texts.
	Self-test Perform a self-test (function not active).



Tab. 16: "Configuration" zone

7.4.1 On/Off

- Select the symbol "On/Off" to set the chiller switch-on or switch-off.

7.4.2 Temperature

- Click on the "Temperature" symbol to display a list of lower-level screen pages.

Symbol	Parameter
	Change unit Set the unit "°C" or "°F"
	Type of adjustment
	Limit values Limit values of the 2 temperature sensors displayed on the main screen

Tab. 17: "Temperature" zone

Temperature > Unit





- All temperature values for the unit may be displayed either in degrees Celsius "°C" or degrees Fahrenheit "°F".
- Click on the "Change unit" symbol.

- Change the required unit ("°C" or "°F") using the "Up" or "Down" arrows.
- Confirm your entry with "OK".

Temperature > Type of adjustment



The chiller can control cooling output according to one of the following two temperature values.

- Click on the "Type of adjustment" symbol.
- Click on the symbol to select the desired setpoint.

Symbol	Parameter
	Setpoint on 1 (circuit 1)
	Setpoint on 2 (circuit 2)
	Adjustment mode (exchanger circuit A)
	Adjustment mode (exchanger circuit B)

Tab. 18: "Setpoint" zone

- Select the symbol relating to the type of adjustment.

Symbol	Parameter
	Absolute (fixed value control) for a constant medium temperature
	Room temperature based control with limit values (only for setpoint 1)
	Room temperature based control without limit values

Tab. 19: "Type of adjustment" zone

- Change the setpoint using the "Up" and "Down" arrows or select the required medium temperature directly.
- Confirm your entry with "OK".

Temperature > Type of adjustment > Absolute

This type of adjustment has been used if the application requires a constant medium temperature. The following parameters will need to be set:

- PSr = setpoint (factory setting: 18 °C)
- Pdr = hysteresis

- PJr = min. setpoint
- PYr = max. setpoint

If the medium temperature is above "PSr+Pdr", the chiller is switched on. If it is below "PSr", the chiller is switched off.

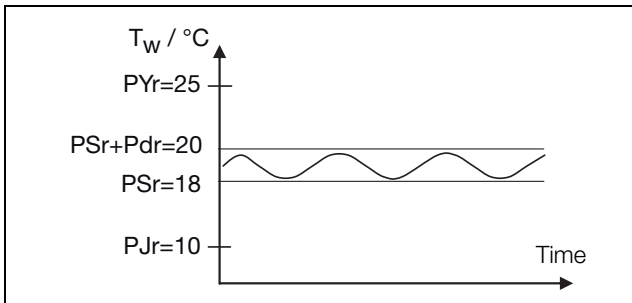

Fig. 16: Type of adjustment "Absolute"

Temperature > Type of adjustment > Room temperature based control with limit values

The following parameters will need to be set:

- PSr = smallest limit value for the cooling medium temperature
- PHc = highest limit value for the cooling medium temperature
- PS1 = smallest limit value for the ambient temperature
- AMB = actual ambient temperature
- PCE = gradient of the compensated setpoint adjustment
- Pdr = hysteresis

If the ambient temperature falls below the parameter value "PS1", fixed value control (absolute) becomes active. The medium temperature is then held at the "PSr" value. If the ambient temperature exceeds the (calculated) parameter value "PS2", also fixed value control (absolute) becomes active. The medium temperature is then held at the "PHc" value.

If the ambient temperature lies between the "PS1" and "PS2" values, the chiller operates in room-temperature-controlled mode. The medium temperature is calculated with the formula $PSr + (AMB - PS1) * PCE$.

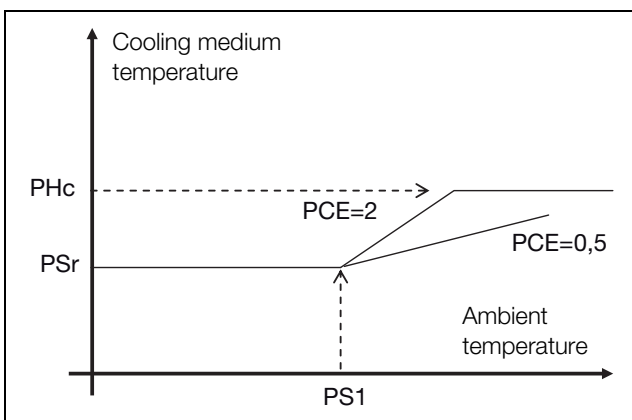

Fig. 17: Type of adjustment "relative with limit values"

Temperature > Type of adjustment > Room temperature based control without limit values

This type of adjustment has to be used if the application requires a medium temperature that varies depending on the ambient temperature. The following parameters will need to be set:

- AMB = actual ambient temperature
- PSr = setpoint as the difference from the ambient temperature
- Pdr = hysteresis

■ Pay attention to the symbol when entering the "PSr" value.

Negative symbol: The medium temperature setpoint lies **below** the ambient temperature.

Positive symbol: The medium temperature setpoint lies **above** the ambient temperature.

If the medium temperature is above "AMB+PSr+Pdr" the chiller is switched on.

If the medium temperature is below "AMB+PSr", the chiller is switched off.

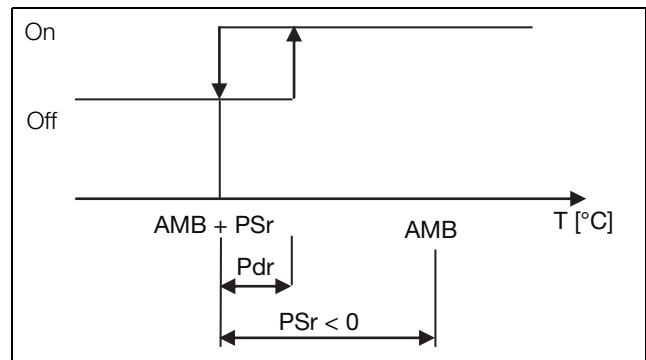

Fig. 18: Type of adjustment "relative with limit values"

7.4.3 Limit values of the temperature values

The values of the two temperature sensors (medium temperature and room temperature) are displayed on the start screen. The value range for the two displays can be adjusted.

- Click on the "Limit values" symbol.
- Choose the desired temperature sensor by selecting it on the display.
- Change the limit value using the "Up" and "Down" arrows or select the required medium temperature directly.
- Confirm the value with "OK".

7.4.4 Language settings

All displays on the unit are available in 5 different languages.

- Click on the "Display language" symbol.
- Page through to the required language using the "Up" and "Down" arrows.
- Confirm the chosen language with "OK".

The language will change over immediately, and all menu displays will appear in the chosen language.

7 Operation

EN

7.5 System messages

We distinguish between three different types of system messages on the unit:

- Malfunctions 
- Errors 
- Servicing 

If a corresponding message applies, the "System messages" symbol is displayed in the menu bar (fig. 14, item 13). A list of all possible system messages may be found in section 9.1 "List of system messages".

■ Click on the "System messages" symbol.

A list of all active system messages will be displayed. The individual messages are arranged in ascending order as they occur according to the above three categories.

If an error message can only be resolved by the Rittal Service team, the "Service" symbol will additionally appear after the error message. .

■ In such cases, please contact Rittal Service (see section 9 "Troubleshooting").

7.5.1 Occurrence of a malfunction

In the event of a malfunction, the start screen will be superimposed with an error message.

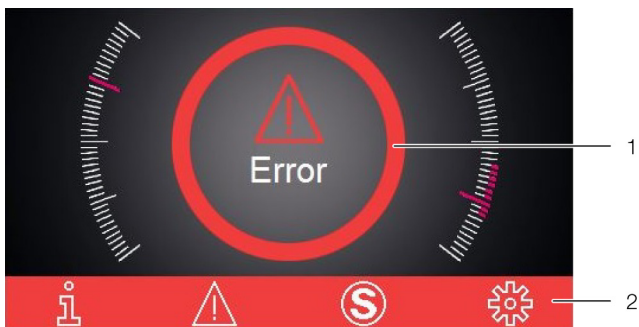

Fig. 19: Screen in the event of a malfunction

Key

- 1 Superimposed
- 2 Menu bar in red

If the malfunctions cannot be resolved by the operator himself, the Service symbol will additionally be displayed (fig. 14, item 14).

■ Contact the Rittal Service team if you are unable to resolve the malfunction yourself (see section 9 "Troubleshooting").

7.5.2 Display in case of errors

If errors have occurred or servicing is required, the "System messages" symbol will appear in the menu bar (see section 7.5 "System messages").

Most system messages are reset automatically once the fault has been resolved.

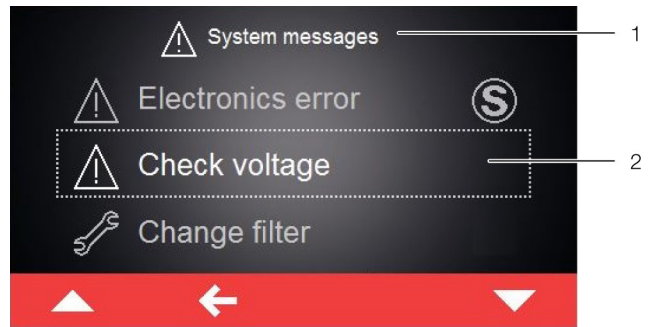

Fig. 20: Screen showing error messages

Key

- 1 "Errors" menu
- 2 Error message

If an error message applies that cannot be resolved by the operator himself and which is not reset automatically, the "Service" symbol will appear after the error message and in the control bar next to the symbol for system messages (fig. 21, item 2).

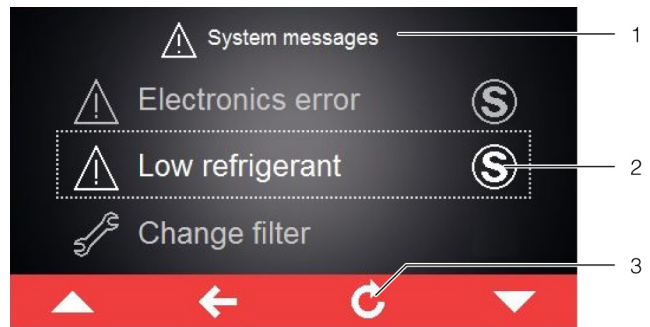

Fig. 21: Screen showing error messages

Key

- 1 "Errors" menu
- 2 Error message
- 3 "Return" button

- Contact Rittal Service (see section 9 "Troubleshooting").
- Acknowledge the error message by pressing the "Return" button.

8 Inspection and maintenance

Proper, regular inspections and maintenance (once a year is recommended) and usage of original spare parts only are crucial for problem-free operation and a long service life of the chiller.

We therefore recommend a maintenance contract.

We offer maintenance service.

Our service contact:

Phone: +49 2772 505-1855

Fax: +49 2772 505-1850

E-mail: service@rittal.de



Danger!

Risk of electric shock at live connections!

Prior to any inspection and maintenance work, the chiller must be disconnected from the power supply.

When the master switch is switched off, the alarm relay is still live. Disconnect signal connector X2 as well.



Caution!

Never use flammable liquids for cleaning.

8.1 Overview of the inspection and maintenance tasks

Assembly	Task	Interval
Cooling medium level	Check for sufficient filling, top up if necessary.	2 weeks or when indicated on the display
Tank, components, and all connections (piping, valves and fittings, hoses) in the circuit for the equipment to be cooled	Check for leaks.	4 weeks
Condenser	Clean fins using compressed air, or with a brush.	3 months
Metal filter (accessory)	Clean with compressed air.	3 months
Cooling medium	Check cooling medium circuit for soiling and any foreign bodies (chips and the like).	3 months
Enclosure	Check the mains voltage value.	3 months

Tab. 20: Inspection and maintenance tasks

Assembly	Task	Interval
Pump motor	Clean with compressed air.	6 months
Cooling medium	Check mix ratio.	6 months
Condenser fan	Check noise generation, clean.	6 months
Access door	Clean with compressed air.	1 year
Condenser and metal filter (accessory)	Clean with a non-corrosive detergent.	1 year
Enclosure	Check the tightening torque of the contactors.	1 year
Fans	Check the tightening torque of the fans.	1 year
Metal filter (accessory)	Replacement	2 years

Tab. 20: Inspection and maintenance tasks

8.2 Maintaining the refrigerant circuit



Note:

The refrigerant circuit is filled with a comparatively small quantity of refrigerant (< 1.5 kg). This means that maintenance to the cooling circuit (such as regular leak checks) is not generally needed.

As a hermetically sealed system, the refrigerant circuit has been filled in the factory with the required amount of refrigerant, tested for leaks and subjected to a function test run.

Maintenance tasks on the refrigerant circuit are only allowed to be undertaken by a specialist refrigeration company. We recommend a maintenance contract that includes an annual inspection of the refrigerant circuit (European regulation EC no. 517/2014 / fluorinated greenhouse gases).

8.3 Monitoring the cooling medium

The fill level of the cooling medium tank is monitored with a level switch. If the fill level drops below the lower limit, a corresponding message will appear on the display (see section 9.1 "List of system messages").

- Top up with cooling medium as soon as possible if indicated by a message on the display.
- Regularly check the quality of the cooling medium, and if necessary, improve it as described under section 6.1.3 "Preparation and care" beschrieben.
- Regularly measure the glycol content with the aid of a refractometer (fig. 22). If you have any questions about this, please contact our service department.

8 Inspection and maintenance

EN

- In order to prevent the formation of fungus and algae, the cooling medium should be replaced at least once a year. The use of pure water may also cause the formation of fungus or algae.

If the chiller is used under certain physical conditions ($T_w < 10\text{ °C}$), condensation may form in the system. This can be minimised by means of suitable insulation or the optionally available room-temperature-based control.



Fig. 22: Refractometer



Note:

The manufacturer's guarantee and liability will be rendered void in cases of incorrect use and treatment of the chiller. To prevent problems in the cooling medium circuit (including water-cooled chillers), it is imperative that the VGB Cooling Water Guidelines (VGB-R 455 P) are observed.

8.4 Cleaning the condenser

To ensure the correct function of the chiller, the fins on the air-cooled condenser must be kept clean. It must be cleaned at regular intervals (see section 8.1 "Overview of the inspection and maintenance tasks"); the frequency of cleaning depends on the degree of soiling in the rooms where the unit is installed.

Ambient air containing oil in conjunction with dust will result in increased soiling of the condenser fins. In such cases, thorough cleaning with compressed air is only possible under certain circumstances. In such cases, the additional use of a metal filter mat is required (see section 11.1 "Metal filter (aluminium filter)").

When cleaning, it is imperative to observe the following warning and safety instructions below.



Danger!

Prior to any inspection and maintenance work, the chiller must be disconnected from the power supply at the master switch.



Caution!

Temperatures of up to 60 °C may occur inside the chiller. Wait approx. 10 min. after you have switched off the chiller to allow the pipe to cool down.



Risk of cuts!

Sharp-edged condenser fins! Use gloves as personal protection equipment.



Caution!

Risk of damage for the condenser fins due to powerful compressed air! Use the compressed air carefully to avoid damage.

When cleaning, please proceed as follows:

- Electrically isolate the chiller at the master switch.
- Secure the master switch to prevent it being switched back on.
- Dismantle the side panel of the chiller and place it somewhere safe.

This gives you access to the condenser in the centre at the back of the chiller.

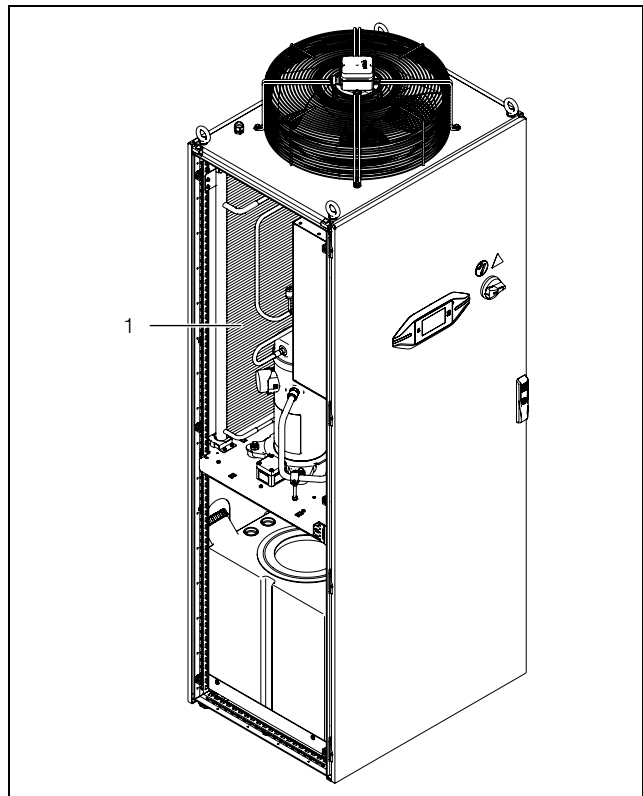

Fig. 23: Cleaning the condenser

Key

1 Condenser

- Use compressed air or a vacuum cleaner with the brush attachment to clean the condenser.
- Reinstall the side panel on the chiller.

8.5 Cleaning the filter mat (accessories)

Metal filter mats may be washed with water or grease-dissolving detergents.

- Remove the metal filter from the two holders on the back of the chiller.

- Clean the metal filter mats e.g. using water and degreaser/detergent.
- Insert the cleaned metal filter between the two holders.

8.6 Draining the cooling medium tank

- Drain the cooling medium tank via the tank drain nozzle (fig. 2, item 6), either directly or using a hose, into a container.
- For disposal of the cooling medium, observe the applicable regulations on water pollution.

9 Troubleshooting

In operation, the chiller operates in a safe state. The chiller maintains the cooling medium inlet temperature at the setpoint set.

Possible causes for deviation from the setpoint could be:

- Cooling demand too high
- Ambient temperature too high
- Failure to observe required distances
- Clogged evaporator coil
- Flow rate too low or too high
- Soiled condenser
- Lack of refrigerant

- Level of cooling medium in tank too low
- Cooling medium temperature set too low
- Parameters set incorrectly

The malfunctions are only allowed to be rectified by suitably instructed, qualified personnel.

For information on malfunction analysis, refer to tab. 21 "Error messages" or contact our service department:

Service contact:

Rittal International Service
 Auf dem Stützelberg
 35745 Herborn

Phone: +49 2772 505-1855







Fax: +49 2772 505-1850

E-mail: service@rittal.de

9.1 List of system messages

The applicable error messages are displayed with the corresponding symbol in the Errors list (see section 7.5 "System messages"). Extended information for resolving individual faults may be found in this section.



Contact details for the Rittal Service team can be found in section 9 "Troubleshooting".

System message	Alarm relay output (factory setting)	Troubleshooting measures/solutions
medium sensor 	Alarm: OFF Warning: ON	Faulty, defective or disconnected chiller adjustment probe. Check connection or contact the Rittal Service team.
antifreeze sensor 1 	Alarm: OFF Warning: ON	Faulty, defective or disconnected chiller antifreeze probe. Check connection or contact the Rittal Service team.
medium sensor inlet 	Alarm: OFF Warning: ON	Faulty, defective or disconnected chiller inlet probe. Check connection or contact the Rittal Service team.
medium sensor outlet 	Alarm: OFF Warning: ON	Faulty, defective or disconnected chiller outlet probe. Check connection or contact the Rittal Service team.
ambient temp.sensor 1 	Alarm: OFF Warning: ON	Faulty, defective or disconnected chiller ambient probe. Check connection or contact the Rittal Service team.
PCB link to display 	Alarm: OFF Warning: ON	No communication between touch display and main board inside the electric control board. The board may be defective or not powered. Check connections or contact the Rittal Service team.
low pressure switch 1 	Alarm: OFF Warning: ON	There may not be enough refrigerant in the refrigerant active circuit. Contact the Rittal Service team.

Tab. 21: Error messages

9 Troubleshooting

EN

System message	Alarm relay output (factory setting)	Troubleshooting measures/solutions
diff. pressure switch 	Alarm: OFF Warning: ON	The fluid pressure between inlet and outlet in the chiller hydraulic circuit is not within the permissible values. Make sure the pressure is within the permissible range. Check for leaks in the hydraulic circuit or contact the Rittal Service team.
flow switch 1 (C) 	Alarm: OFF Warning: ON	There is no flow in the hydraulic circuit. Check for leaks in the hydraulic circuit or contact the Rittal Service team.
flow switch 1 (W) 	Alarm: ON Warning: OFF	There is no flow in the hydraulic circuit. Check for leaks in the hydraulic circuit or contact the Rittal Service team.
flow switch 1 (H-C) 	Alarm: OFF Warning: ON	There is no flow in the hydraulic circuit. Check for leaks in the hydraulic circuit or contact the Rittal Service team.
antifreeze thermostat 1 	Alarm: OFF Warning: ON	The temperature in the cooling circuit is below the limit value. Contact the Rittal Service team.
level switch 1 (H-C) 	Alarm: OFF Warning: ON	The fluid level in the tank is below the limit value. Fill the tank after checking that the latter does not leak, or contact the Rittal Service team.
level switch 1 (W) 	Alarm: ON Warning: OFF	The fluid level in the tank is below the limit value. Fill the tank after checking that the latter does not leak, or contact the Rittal Service team.
door switch 	Alarm: OFF Warning: ON	Close the control cabinet doors or check the door contact switch. Alternatively, contact the Rittal Service team.
high press.switch 1 	Alarm: OFF Warning: ON	The pressure in the cooling circuit is higher than the limit value. Check that the amount of gas in the cooling circuit is correct or contact the Rittal Service team.
breaker switch pump 1 	Alarm: OFF Warning: ON	The current absorbed by the heater is greater than the set of the corresponding motor protection switch. Check that the motor protection switch is correctly set and that the motor phases are connected. Alternatively, contact the Rittal Service team.
breaker switch compr.1 	Alarm: OFF Warning: ON	The current absorbed by the heater is greater than the set of the corresponding motor protection switch. Check that the motor protection switch is correctly set and that the motor phases are connected. Alternatively, contact the Rittal Service team.
breaker switch fans 1 	Alarm: OFF Warning: ON	The current absorbed by the heater is greater than the set of the corresponding motor protection switch. Check that the motor protection switch is correctly set and that the motor phases are connected. Alternatively, contact the Rittal Service team.
breaker switch heater 	Alarm: OFF Warning: ON	The current absorbed by the heater is greater than the set of the corresponding motor protection switch. Check that the motor protection switch is correctly set and that the resistor phases are connected. Alternatively, contact the Rittal Service team.













Tab. 21: Error messages

System message	Alarm relay output (factory setting)	Troubleshooting measures/solutions
phase monitoring 	Alarm: OFF Warning: ON	The chiller does not work within the permissible voltage range. Check the chiller power supply voltage and respect the values indicated on the identification plate. In case of three-phase power supply, also check that all phases are properly connected.
dirty filter 1 	Alarm: ON Warning: OFF	The chiller filters may be dirty. Replace or clean the filter and confirm its replacement by resetting the list of system messages on the chiller display. Alternatively, contact the Rittal Service team.
level switch 2 (H-C) 	Alarm: OFF Warning: ON	The fluid level in the tank is below the limit value. Fill the tank after checking that the latter does not leak, or contact the Rittal Service team.
level switch 2 (W) 	Alarm: ON Warning: OFF	The fluid level in the tank is below the limit value. Fill the tank after checking that the latter does not leak, or contact the Rittal Service team.
breaker switch pump 2 	Alarm: OFF Warning: ON	The current absorbed by Pump 2 is greater than the set of the corresponding motor protection switch. Check that the motor protection switch is correctly set and that the motor phases are connected. Alternatively, contact the Rittal Service team.
flow switch 2 (C) 	Alarm: OFF Warning: ON	There is no flow in the hydraulic circuit. Check for leaks in the hydraulic circuit or contact the Rittal Service team.
flow switch 2 (W) 	Alarm: ON Warning: OFF	There is no flow in the hydraulic circuit. Check for leaks in the hydraulic circuit or contact the Rittal Service team.
flow switch 2 (H-C) 	Alarm: OFF Warning: ON	There is no flow in the hydraulic circuit. Check for leaks in the hydraulic circuit or contact the Rittal Service team.
breaker switch compr. 2 	Alarm: OFF Warning: ON	The current absorbed by Compressor 2 is greater than the set of the corresponding motor protection switch. Check that the motor protection switch is correctly set and that the motor phases are connected. Alternatively, contact the Rittal Service team.
breaker switch fans 2 	Alarm: OFF Warning: ON	The current absorbed by Fan 2 is greater than the set of the corresponding motor protection switch. Check that the motor protection switch is correctly set and that the motor phases are connected. Alternatively, contact the Rittal Service team.
high press.switch 2 	Alarm: OFF Warning: ON	The pressure in the cooling circuit 2 is higher than the limit value. Check that the amount of gas in the cooling circuit is correct or contact the Rittal Service team.
low press.switch 2 	Alarm: OFF Warning: ON	The pressure in the cooling circuit 2 is below the limit value. Check that the amount of gas in the cooling circuit is correct or contact the Rittal Service team.
antifreeze thermostat 2 	Alarm: OFF Warning: ON	The temperature in the cooling circuit is below the limit value. Contact the Rittal Service team.













Tab. 21: Error messages

9 Troubleshooting

EN

System message	Alarm relay output (factory setting)	Troubleshooting measures/solutions
dirty filter 2 	Alarm: ON Warning: OFF	The chiller filters may be dirty. Replace or clean the filter and confirm its replacement by resetting the list of system messages on the chiller display. Alternatively, contact the Rittal Service team.
medium temp. too high 	Alarm: ON Warning: OFF	The chiller adjustment temperature is not within the permitted set values. Make sure that the fluid temperature does not exceed the set range (Default: +3 °C...+40 °C if in ABS; ± 5 °C if in REL) Alternatively, contact the Rittal Service team.
medium temp. too low 	Alarm: ON Warning: OFF	The chiller adjustment temperature is not within the permitted set values. Make sure that the fluid temperature does not exceed the set range (Default: +3 °C...+40 °C if in ABS; ± 5 °C if in REL) Alternatively, contact the Rittal Service team.
antifreeze temp. 1 	Alarm: OFF Warning: ON	The temperature in the cooling circuit is below the limit value. Contact the Rittal Service team.
ambient temp.sensor 2 	Alarm: OFF Warning: ON	Faulty, defective or disconnected chiller ambient probe 2. Check connection or contact the Rittal Service team.
ambient temp. too high 2 	Alarm: ON Warning: OFF	The chiller ambient temperature 2 is not within the permitted values. Make sure that the ambient temperature is within the permitted range (-20 °C...+60 °C). Alternatively, contact the Rittal Service team.
ambient temp. too low 2 	Alarm: ON Warning: OFF	The chiller ambient temperature 2 is not within the permitted values. Make sure that the ambient temperature is within the permitted range (-20 °C...+60 °C). Alternatively, contact the Rittal Service team.
user sensor 2 	Alarm: OFF Warning: ON	Faulty, defective or disconnected chiller user probe. Check connection or contact the Rittal Service team.
comp. discharge sensor 1 	Alarm: OFF Warning: ON	Faulty, defective or disconnected chiller discharge probe. Check connection or contact the Rittal Service team.
pressure sensor 1 	Alarm: OFF Warning: ON	Faulty, defective or disconnected air pressure transducer. Check connection or contact the Rittal Service team.
press.sensor pump 1 	Alarm: OFF Warning: ON	Faulty, defective or disconnected water pressure transducer. Check connection or contact the Rittal Service team.
press.sensor pump 2 	Alarm: OFF Warning: ON	Faulty, defective or disconnected water pressure transducer 2. Check connection or contact the Rittal Service team.
pressure sensor 2 	Alarm: OFF Warning: ON	Faulty, defective or disconnected air pressure transducer 2. Check connection or contact the Rittal Service team.



Tab. 21: Error messages

System message	Alarm relay output (factory setting)	Troubleshooting measures/solutions
comp. discharge sensor 2 	Alarm: OFF Warning: ON	Faulty, defective or disconnected chiller discharge probe 2. Check connection or contact the Rittal Service team.
antifreeze sensor 2 	Alarm: OFF Warning: ON	Faulty, defective or disconnected chiller antifreeze probe 2. Check connection or contact the Rittal Service team.
antifreeze temp. 2 	Alarm: OFF Warning: ON	The temperature in the cooling circuit is below the limit value. Contact the Rittal Service team.
pCOe link to PCB 	Alarm: OFF Warning: ON	No communication between PCB and pCOe inside the electric control board. The device may be defective or not powered. Check connections or contact the Rittal Service team.
ambient temp. too high 1 	Alarm: ON Warning: OFF	The chiller ambient temperature is not within the permitted values. Make sure that the ambient temperature is within the permitted range (-20 °C...+60 °C). Alternatively, contact the Rittal Service team.
ambient temp. too low 1 	Alarm: ON Warning: OFF	The chiller ambient temperature is not within the permitted values. Make sure that the ambient temperature is within the permitted range (-20 °C...+60 °C) Alternatively, contact the Rittal Service team.
sensor low pressure 1 	Alarm: ON Warning: OFF	The chiller condensation pressure is not within the permitted values. Make sure the pressure is within the permissible range (+1 bar...+49 bar). Alternatively, contact the Rittal Service team.
sensor high pressure 1 	Alarm: ON Warning: OFF	The chiller condensation pressure is not within the permitted values. Make sure the pressure is within the permissible range (+1 bar...+49 bar). Alternatively, contact the Rittal Service team.
sensor low pressure 2 	Alarm: ON Warning: OFF	The chiller condensation pressure is not within the permitted values. Make sure the pressure is within the permissible range (+1 bar...+49 bar). Alternatively, contact the Rittal Service team.
sensor high pressure 2 	Alarm: ON Warning: OFF	The chiller condensation pressure is not within the permitted values. Make sure the pressure is within the permissible range (+1 bar...+49 bar). Alternatively, contact the Rittal Service team.
sensor circuit 1A 	Alarm: ON Warning: OFF	Faulty, defective or disconnected Exchange Circuit 1 probe. Check connection or contact the Rittal Service team.
sensor circuit 1B 	Alarm: ON Warning: OFF	Faulty, defective or disconnected Exchange Circuit 2 probe. Check connection or contact the Rittal Service team.
temp. circuit 1A too high 	Alarm: ON Warning: OFF	Exchange Circuit 1 The chiller adjustment temperature is not within the permitted set values. Make sure that the fluid temperature does not exceed the set range (Default: +45 °C). Alternatively, contact the Rittal Service team.

Tab. 21: Error messages

10 Decommissioning and disposal

EN

System message	Alarm relay output (factory setting)	Troubleshooting measures/solutions
temp. circuit 1B too high 	Alarm: ON Warning: OFF	Exchange Circuit 2 The chiller adjustment temperature is not within the permitted set values. Make sure that the fluid temperature does not exceed the set range (Default: +45 °C). Alternatively, contact the Rittal Service team.
temp. circuit 2 too high 	Alarm: ON Warning: OFF	Main Circuit 2 – 3-Way Valve The chiller adjustment temperature is not within the permitted set values. Make sure that the fluid temperature does not exceed the set range (Default: +45 °C). Alternatively, contact the Rittal Service team.

Tab. 21: Error messages

10 Decommissioning and disposal

The chiller is only allowed to be shut down by authorised, qualified personnel. For this purpose the chiller must be decommissioned.

10.1 Decommissioning

If the chiller is not to be used for an extended period (more than 6 months) the cooling medium circuit must be drained. This will prevent the evaporation of water, and the water-glycol ratio of the cooling medium will not be altered. If the glycol thickens, the cooling medium pump seal may be irreparably damaged.

- Electrically isolate the chiller at the master switch.
- Secure the master switch to prevent it being switched back on.
- Disconnect all electrical connections to the chiller (mains connector, signal connector and IoT interface).
- Drain the cooling medium tank via the tank drain nozzle (fig. 2, item 7), either directly or using a hose, into a container.
- For disposal of the cooling medium, observe the applicable regulations on water pollution.
- Disconnect and dismantle the cooling medium circuit connections.
- To recommission the chiller, proceed as described in section 6 "Commissioning". Make the same checks as described in that section.

10.2 Disposal



Caution!
Risk for the environment! Intentional release of the refrigerant is strictly prohibited. Refrigerant must be disposed of properly.

- Decommission the chiller (see section 10.1 "Decommissioning").
- Notify your supplier or our service department for proper disposal of the chiller.

Certificate in accordance with BGR 500 chap. 2.35 and DIN EN 378-2 on the inspection of a cooling system



Note:

If a system is changed or taken out of operation for more than 2 years, it is to be re-inspected and a new certificate issued. A system has been modified:

- if a system is opened and converted to a different refrigerant,
- if stationary system is moved elsewhere,
- if an existing system is extended or converted
- or major improvements are carried out.

11 Accessories

11.1 Metal filter (aluminium filter)

Particularly when chiller units are used in dusty and oil-laden environments, it is advisable to use washable metal filters. If air or steam condenses on the metal surfaces, any particles that may be present will adhere to the metal and are easily washed out with water or grease-dissolving detergents.

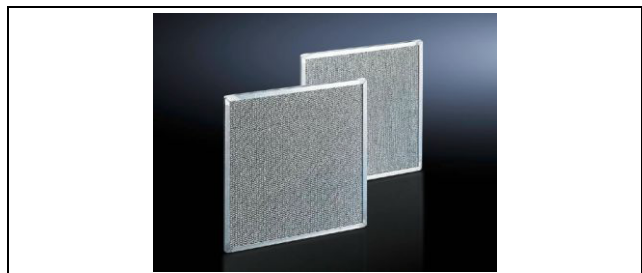

Fig. 24: Metal filters

Packs of	Model No.
1	3286620

Tab. 22: Metal filters

11.2 Cooling medium for chillers (ready-mix)

Chiller systems are only suitable for the cooling of a water-glycol mixture. As well as protecting against frost,

this cooling medium also serves to inhibit bacterial growth and provide optimum corrosion protection.



Fig. 25: Cooling medium for chillers (ready-mix)

Mixing ratio	Content	Model No.
1:4 (indoor)	10 l	3301960
	25 l	3301965
	200 l	3301967
1:2 (outdoor)	10 l	3301950
	25 l	3301955
	200 l	3301957

Tab. 23: Cooling medium for chillers (ready-mix)

11.3 Twin castors

With the help of twin castors the chiller can be moved and thus used at different production locations.



Fig. 26: Twin castors

Mounting thread	Maximum admissible static load (per castor)	Model No.
M12 x 20	120 kg	7495000

Tab. 24: Twin castors

11.4 Levelling feet

To compensate for height differences with floor irregularities. Mounting thread M12. Optionally with hex socket for adjustment from the inside of the enclosure.



Fig. 27: Levelling feet

Mounting thread	Maximum admissible static load (per component)	Model No.
M12 x 60	300 kg	7493100

Tab. 25: Levelling feet

11.5 Base/plinth corner piece with base/plinth trim panels, front and rear

Heavy-duty base/plinth corner pieces with moulded self-positioning to the enclosure, may be used with or without trim panels depending on the application. Large openings in the base/plinth corner piece for optimum access to the screw-fastening point, may be concealed with a plastic corner piece and baying cover.

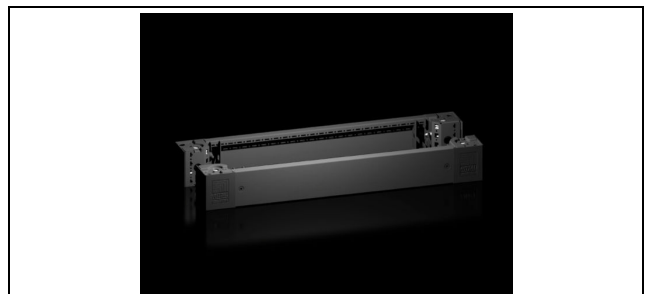

Fig. 28: Base/plinth corner piece with base/plinth trim panels, front and rear

Height	Model No.
100 mm	8640003
200 mm	8640023

Tab. 26: Base/plinth corner piece with base/plinth trim panels, front and rear

11.6 Base/plinth trim panels, side, for base/plinth system VX, sheet steel

To finish off a base/plinth unit at the sides and for additional stability, or for the interior installation of bayed base/plinths. One 200 mm high or two 100 mm high trim panels may optionally be fitted on 200 mm high base/plinths.

11 Accessories

EN



Fig. 29: Base/plinth trim panels, side, for base/plinth system VX, sheet steel

Height	To fit depth	Model No.
100 mm	600 mm	8640033
200 mm	600 mm	8640043

Tab. 27: Base/plinth trim panels, side, for base/plinth system VX, sheet steel

11.7 Cross member

To increase stability, the cross member is positioned below the base frame of the enclosure and protrudes 138 mm at the front and rear.

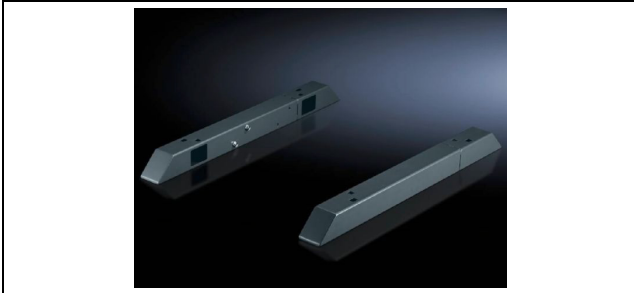

Fig. 30: Cross member

Height	Model No.
70 mm	8601680

Tab. 28: Cross member

11.8 Comfort handle VX

Thanks to its folding action, the handle does not take up any swing space, thus maximising the door surface area available for installed equipment. Simple assembly, thanks to the snap-mounted handle system.



Fig. 31: Comfort handle VX

Packs of	Model No.
1	8618250

Tab. 29: Comfort handle VX

11.9 Security lock insert, lock no. 3524 E

Lock and push-button inserts and profile half-cylinders with a length of 40 mm.

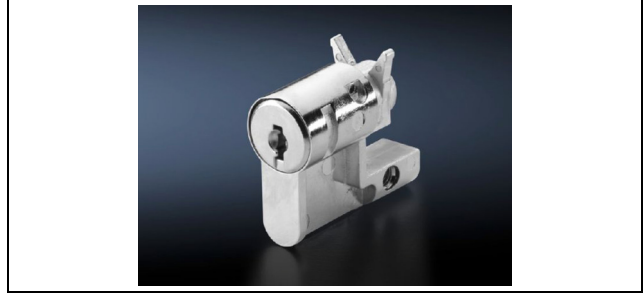

Fig. 32: Security lock insert, lock no. 3524 E

Packs of	Model No.
1	2467000

Tab. 30: Security lock insert, lock no. Nr. 3524 E

11.10 Push-button insert

Lock and push-button inserts and profile half-cylinders with a length of 40 mm.



Fig. 33: Push-button insert

Packs of	Model No.
1	2468000

Tab. 31: Push-button insert

12 Appendix

12.1 Block diagram

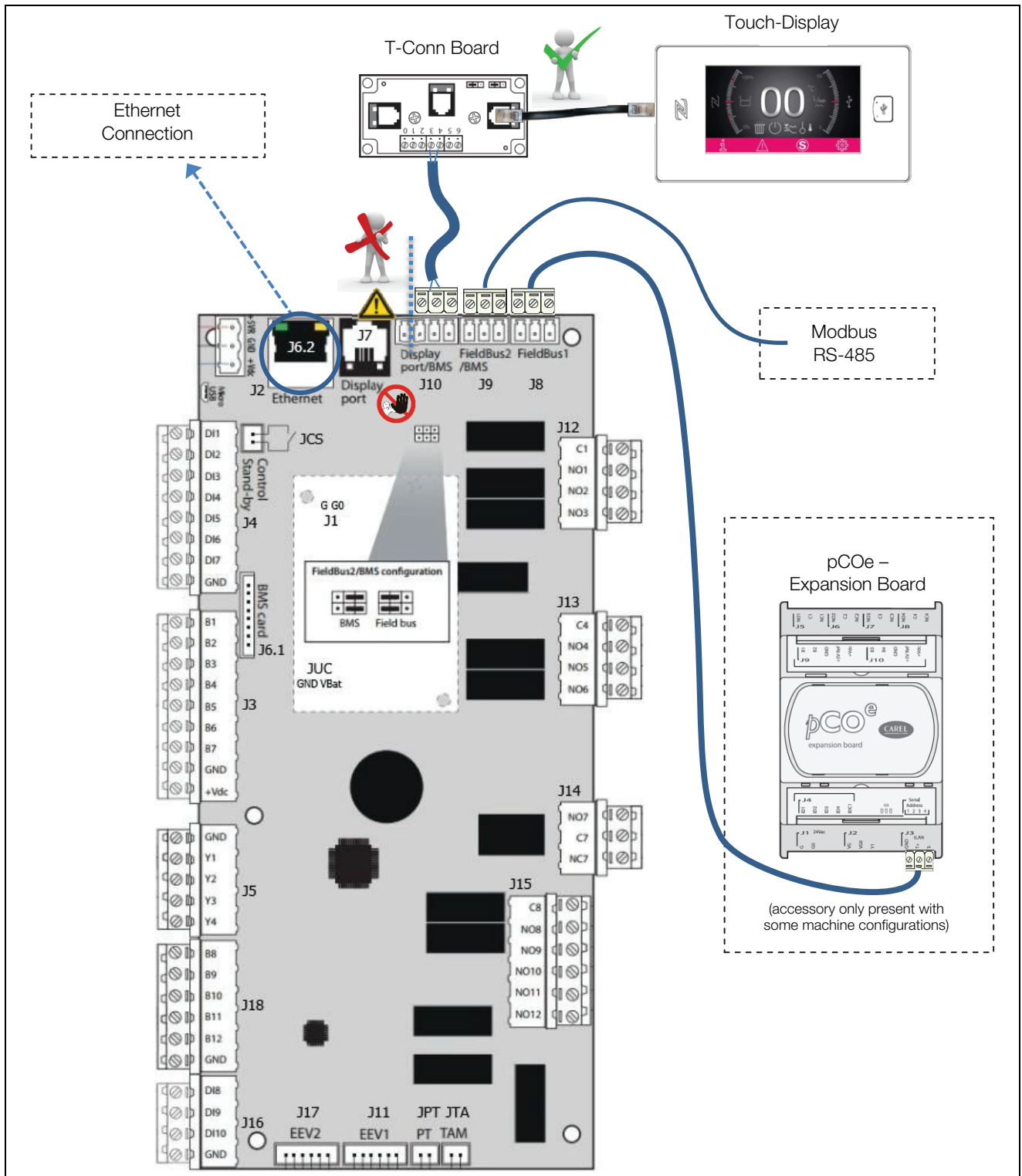

Fig. 34: Block diagram



Note:
The complete circuit diagram is available for download on the Rittal website.



Note:
Never connect the Touch display directly to the J7 connector (RJ12) on the μPC board. Always use the T-Conn board connected to J8.

12.2 Hardware configuration

12.2.1 Digital Inputs

IDxx μPC	Standard Device	Optional Device
ID1	Compressor 1	
ID2	Fans	
ID3	Pump 1 (water circuit 1)	
ID4	High Pressure Switch	
ID5	Low Pressure Switch	
ID6		Pre-heating Heater
ID7	PhaseSequenceControl	
ID8		Water Flow Switch 1 (water circuit 1)
ID9	Water Level 1	
ID10		Pump 2 (water circuit 2)
IDx pCOe Exp.	Standard Device	Optional Device
ID1		Water Flow Switch 2 (water circuit 2)
ID2		Water Level 2
ID3		Compressor 2
ID4		–

Tab. 32: Digital Inputs

12.2.2 Analogue Inputs

Yx μPC	Standard Device	Optional Device
Y1		Fans Speed Variator
Y2		Modulating 3-Way Valve (water circuit 2)
Y3		Hot Gas Bypass Valve (PID) (water circuit 2)
Y4		–

Tab. 33: Analogue Inputs

12.2.3 Digital Outputs

NOxx μPC	Standard Device	Optional Device
NO1	Compressor	
NO2	Fans	
NO3	Pump 1 (water circuit 1)	
NO4	Warning Signal	
NO5	Alarm Signal	
NO6	Temperature Alarm Signal	
NO7		Hot Gas Bypass Valve (ON/OFF)
NO8		Pump 2 (water circuit 2)
NO9		Pre-heating Heater
NO10		Liquid Injection Discharge Valve
NO11		Compressor 2
NO12		–

Tab. 34: Digital Outputs

12.2.4 Analogue Outputs

Bxx μPC	Standard Device	Optional Device
B1	Outlet Probe 1 (water circuit 1)	
B2	Ambient Probe 1	
B3	Antifreeze Probe	
B4		Liquid Injection Supply Probe
B5		–
B6		Inlet Probe (water circuit 1)
B7		Outlet Probe 2 (water circuit 2)
B8		Ambient Probe 2
B9		–
B10		Pressure Transducer

Tab. 35: Digital Outputs

Bxx µPC	Standard Device	Optional Device
B11		–
B12		–

Tab. 35: Digital Outputs

12.3 Spare parts

You can find spare parts on the relevant Rittal website under the relevant Model No.



Note:

The components used are Rittal-specific components. We recommend using only original Rittal spare parts to ensure the guaranteed unit properties (output).

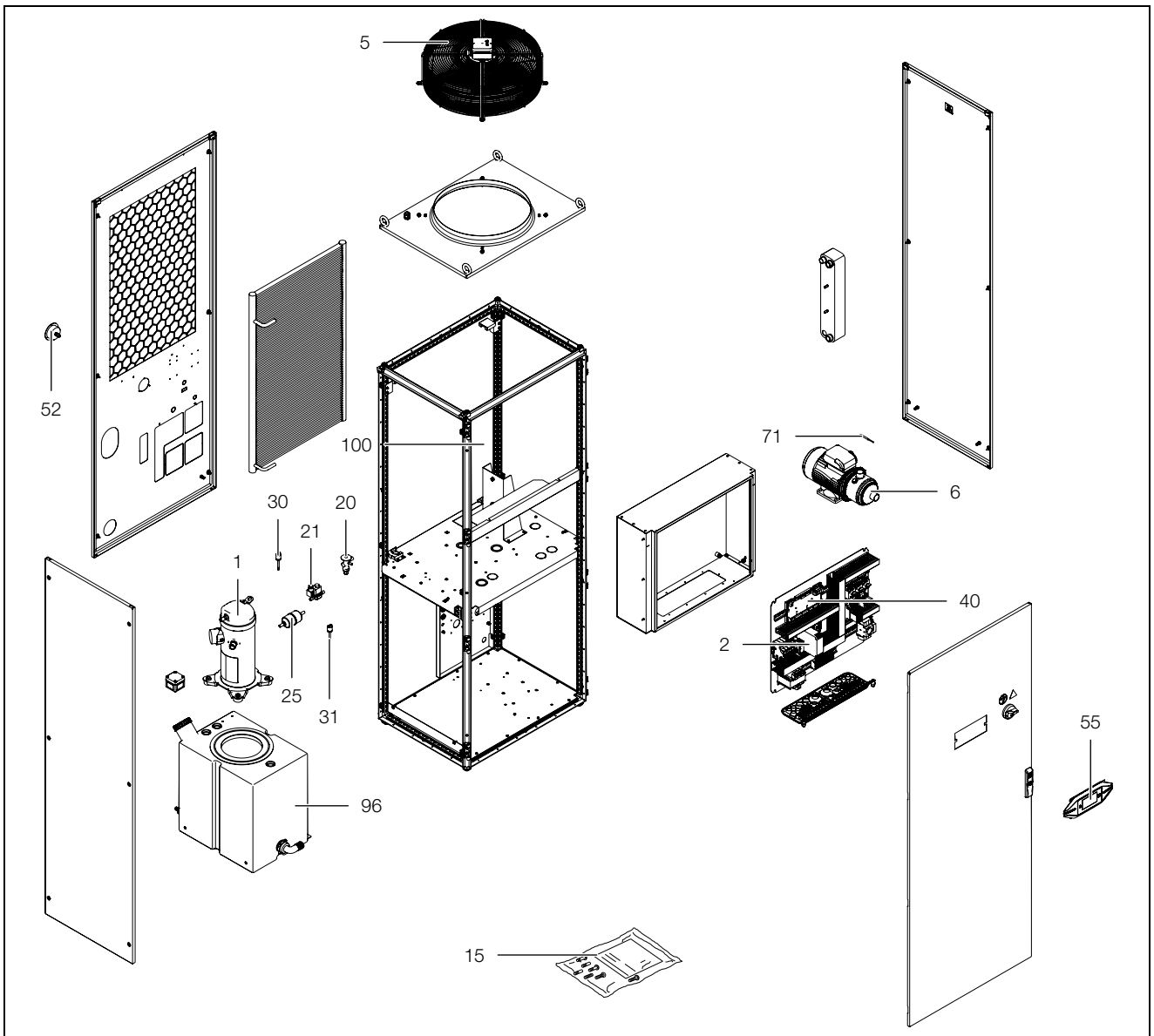

Fig. 35: Spare parts drawing

Key

- | | |
|-----------------------|-----------------------|
| 1 Compressor | 40 Controller |
| 2 Phase relay | 52 Manometer |
| 5 Axial fan | 55 Display |
| 6 Cooling medium pump | 70 Temperature sensor |
| 20 Expansion valve | 71 Temperature sensor |
| 21 Bypass valve | 75 Level switch |
| 25 Dryer | 96 Tank |
| 30 Pressostat | |
| 31 Pressostat | |

12 Appendix

EN

12.4 List of supervised variables

Modbus TCP/IP		Modbus BMS2		R/W	Description	Value			
Type	Idx	Type	Idx			DEF	MIN	MAX	UoM
In St	2	In St	2	R	High Pressure Switch Alarm [0 → Alarm Off; 1 → Alarm On]	-	0	1	-
In St	3	In St	3	R	Low Pressure Switch Alarm [0 → Alarm Off; 1 → Alarm On]	-	0	1	-
In St	6	In St	6	R	Antifreeze Alarm [0 → Alarm Off; 1 → Alarm On]	-	0	1	-
In St	7	In St	7	R	Electric Level Switch Alarm [0 → Alarm Off; 1 → Alarm On]	-	0	1	-
In St	8	In St	8	R	Flow Switch Alarm [0 → Alarm Off; 1 → Alarm On]	-	0	1	-
In St	9	In St	9	R	Compressor Motor Protection Switch Alarm [0 → Alarm Off; 1 → Alarm On]	-	0	1	-
In St	10	In St	10	R	Fan Motor Protection Switch Alarm [0 → Alarm Off; 1 → Alarm On]	-	0	1	-
In St	11	In St	11	R	Pump Motor Protection Switch Alarm [0 → Alarm Off; 1 → Alarm On]	-	0	1	-
In St	12	In St	12	R	Ambient Probe Alarm [0 → Alarm Off; 1 → Alarm On]	-	0	1	-
In St	13	In St	13	R	Inlet Probe Alarm [0 → Alarm Off; 1 → Alarm On]	-	0	1	-
In St	14	In St	14	R	Outlet Probe Alarm [0 → Alarm Off; 1 → Alarm On]	-	0	1	-
In St	15	In St	15	R	Antifreeze Probe Alarm [0 → Alarm Off; 1 → Alarm On]	-	0	1	-
In St	16	In St	16	R	High Ambient Temperature Alarm [0 → Alarm Off; 1 → Alarm On]	-	0	1	-
In St	17	In St	17	R	High Temperature Alarm [0 → Alarm Off; 1 → Alarm On]	-	0	1	-
In St	18	In St	18	R	Low Ambient Temperature Alarm [0 → Alarm Off; 1 → Alarm On]	-	0	1	-
In St	19	In St	19	R	Low Temperature Alarm [0 → Alarm Off; 1 → Alarm On]	-	0	1	-
In St	20	In St	20	R	High Pressure Alarm [0 → Alarm Off; 1 → Alarm On]	-	0	1	-
In St	21	In St	21	R	Low Pressure Alarm [0 → Alarm Off; 1 → Alarm On]	-	0	1	-
In St	22	In St	22	R	Ambient Probe 2 Alarm [0 → Alarm Off; 1 → Alarm On]	-	0	1	-
In St	23	In St	23	R	High Ambient 2 Temperature Alarm [0 → Alarm Off; 1 → Alarm On]	-	0	1	-

Tab. 36: List of supervised variables

Modbus TCP/IP		Modbus BMS2		R/W	Description	Value			
Type	Idx	Type	Idx			DEF	MIN	MAX	UoM
In St	24	In St	24	R	Low Ambient 2 Temperature Alarm [0 → Alarm Off; 1 → Alarm On]	-	0	1	-
In St	25	In St	25	R	User Probe Alarm [0 → Alarm Off; 1 → Alarm On]	-	0	1	-
In St	26	In St	26	R	Discharge Probe Alarm [0 → Alarm Off; 1 → Alarm On]	-	0	1	-
In St	27	In St	27	R	Compressor 2 Motor Protection Switch Alarm [0 → Alarm Off; 1 → Alarm On]	-	0	1	-
In St	28	In St	28	R	Phase Control Alarm [0 → Alarm Off; 1 → Alarm On]	-	0	1	-
In St	29	In St	29	R	Air Filter Alarm [0 → Alarm Off; 1 → Alarm On]	-	0	1	-
In St	31	In St	31	R	Flow Switch 2 Warning Signal [0 → Alarm Signal Off; 1 → Alarm Signal On]	-	0	1	-
In St	32	In St	32	R	Flow Switch 2 Cooling Water Alarm [0 Alarm Off; 1 → Alarm On]	-	0	1	-
In St	34	In St	34	R	Level Switch 2 Warning Signal [0 → Alarm Signal Off; 1 → Alarm Signal On]	-	0	1	-
In St	35	In St	35	R	Pump 2 Motor Protection Switch Alarm [0 → Alarm Off; 1 → Alarm On]	-	0	1	-
In St	37	In St	37	R	Air Pressure Transducer Alarm [0 → Alarm Off; 1 → Alarm On]	-	0	1	-
In St	38	In St	38	R	Water Pressure Transducer Alarm [0 → Alarm Off; 1 → Alarm On]	-	0	1	-
In St	39	In St	39	R	Water Pressure Transducer 2 Alarm [0 → Alarm Off; 1 → Alarm On]	-	0	1	-
In St	40	In St	40	R	pCO _e Offline Alarm [0 → Alarm Off; 1 → Alarm On]	-	0	1	-
In St	41	In St	41	R	Compressor 2 Status [0 → Off; 1 → On]	-	0	1	-
In St	42	In St	42	R	Compressor (Circuit 2) Status [0 → Off; 1 → On]	-	0	1	-
In St	43	In St	43	R	Fan (Circuit 2) Motor Protection Switch Alarm [0 → Off; 1 → On]	-	0	1	-
In St	44	In St	44	R	Fan (Circuit 2) Status [0 → Off; 1 → On]	-	0	1	-
In St	45	In St	45	R	Air Pressure Transducer 2 Alarm [0 → Alarm Off; 1 → Alarm On]	-	0	1	-
In St	46	In St	46	R	High Pressure Alarm (Circuit 2) [0 → Alarm Off; 1 → Alarm On]	-	0	1	-
In St	47	In St	47	R	Low Pressure Alarm (Circuit 2) [0 → Alarm Off; 1 → Alarm On]	-	0	1	-
In St	49	In St	49	R	Discharge Probe Alarm (Circuit 2) [0 → Alarm Off; 1 → Alarm On]	-	0	1	-

Tab. 36: List of supervised variables

12 Appendix

EN

Modbus TCP/IP		Modbus BMS2		R/W	Description	Value			
Type	Idx	Type	Idx			DEF	MIN	MAX	UoM
InSt	50	InSt	50	R	High Pressure Switch Alarm (Circuit 2) [0 → Alarm Off; 1 → Alarm On]	-	0	1	-
InSt	52	InSt	52	R	Low Pressure Switch Alarm (Circuit 2) [0 → Alarm Off; 1 → Alarm On]	-	0	1	-
InSt	55	InSt	55	R	Antifreeze Thermostat Alarm (Circuit 2) [0 → Alarm Off; 1 → Alarm On]	-	0	1	-
InSt	56	InSt	56	R	Antifreeze Probe 2 Alarm [0 → Alarm Off; 1 → Alarm On]	-	0	1	-
InSt	59	InSt	59	R	Flow Switch Cooling Alarm [0 → Alarm Off; 1 → Alarm On]	-	0	1	-
InSt	60	InSt	60	R	Flow Switch Warning Signal [0 → Alarm Signal Off; 1 → Alarm Signal On]	-	0	1	-
InSt	61	InSt	61	R	Level Switch Warning Signal [0 → Alarm Signal Off; 1 → Alarm Signal On]	-	0	1	-
InSt	63	InSt	63	R	Pump Control [0 → Off; 1 → On]	-	0	1	-
InSt	64	InSt	64	R	Pump 2 Control [0 → Off; 1 → On]	-	0	1	-
InSt	65	InSt	65	R	Heater Motor Protection Switch Alarm [0 → Off; 1 → On]	-	0	1	-
InSt	70	InSt	70	R	HGBP Valve Status [0 → Close; 1 → Open]	-	0	1	-
InSt	71	InSt	71	R	HGBP Valve Status (Circuit 2) [0 → Close; 1 → Open]	-	0	1	-
InSt	72	InSt	72	R	Heater Status [0 → Off; 1 → On]	-	0	1	-
InSt	73	InSt	73	R	General Alarm [0 → Off; 1 → On]	-	0	1	-
InSt	74	InSt	74	R	Alarm Control [0 → All Alarms; 1 → Only Serious Alarms]	-	0	1	-
InSt	75	InSt	75	R	Warning Signal [0 → Off; 1 → On]	-	0	1	-
InSt	79	InSt	79	R	Temperature Alarm [0 → Off; 1 → On]	-	0	1	-
InSt	80	InSt	80	R	High Temperature Alarm [0 → Off; 1 → On]	-	0	1	-
InSt	81	InSt	81	R	Low Temperature Alarm [0 → Off; 1 → On]	-	0	1	-
InSt	82	InSt	82	R	Acoustic Signal Stop	-	0	1	-
InSt	101	InSt	101	R	Compressor Status [0 → Off; 1 → On]	-	0	1	-
InSt	102	InSt	102	R	Pump Status [0 → Off; 1 → On]	-	0	1	-
InSt	103	InSt	103	R	Fan Status [0 → Off; 1 → On]	-	0	1	-
InSt	106	InSt	106	R	Pump 2 Status [0 → Off; 1 → On]	-	0	1	-
CoSt	132	CoSt	132	R/W	Unit Status [0 → Off; 1 → On]	-	0	1	-
CoSt	83	CoSt	83	R/W	3-Way Valve Operating [0 → Absolute Mode; 1 → Differential]	0	0	1	-

Tab. 36: List of supervised variables

Modbus TCP/IP		Modbus BMS2		R/W	Description	Value			
Type	Idx	Type	Idx			DEF	MIN	MAX	UoM
In Rg	2	In Rg	2	R	Temperature measured by the Ambient Probe 2	-	-99.9	+99.9	°C
In Rg	3	In Rg	3	R	Temperature measured by the User Probe	-	-99.9	+99.9	°C
In Rg	4	In Rg	4	R	Temperature measured by the Hot Gas Probe	-	-99.9	+99.9	°C
In Rg	6	In Rg	6	R	Pressure measured by the Pressure Transducer (Circuit 2)	-	0	99.9	bar
In Rg	7	In Rg	7	R	Temperature measured by the Hot Gas Probe (Circuit 2)	-	-99.9	+99.9	°C
In Rg	8	In Rg	8	R	Temperature measured by the Antifreeze Probe (Circuit 2)	-	-99.9	+99.9	°C
In Rg	11	In Rg	11	R	Fan Speed	-	0	99.9	%
In Rg	12	In Rg	12	R	Fan Speed (Circuit 2)	-	0	99.9	%
In Rg	19	In Rg	19	R/W	Set point Lower Limit for Operation in Cooling Compensation	-	-99.9	+99.9	°C
In Rg	20	In Rg	20	R/W	Set point Higher Limit for Operation in Cooling Compensation	-	-99.9	+99.9	°C
In Rg	71	In Rg	71	R	Temperature measured by the Regulation Probe	-	-99.9	+99.9	°C
In Rg	72	In Rg	72	R	Temperature measured by the Inlet Probe	-	-99.9	+99.9	°C
In Rg	73	In Rg	73	R	Temperature measured by the Outlet Probe	-	-99.9	+99.9	°C
In Rg	74	In Rg	74	R	Temperature measured by the Ambient Probe	-	-99.9	+99.9	°C
In Rg	75	In Rg	75	R	Temperature measured by the Antifreeze Probe	-	-99.9	+99.9	°C
In Rg	76	In Rg	76	R	Pressure measured by the Pressure Transducer	-	0	99.9	bar
Hd Rg	23	Hd Rg	23	R/W	Operating Set point for 3-Way Valve	+20	-99.9	+99.9	°C
Hd Rg	24	Hd Rg	24	R/W	Differential Operating Set point for 3-Way Valve	-2	-99.9	+99.9	°C
Hd Rg	26	Hd Rg	26	R/W	Set point Variation Gradient	1	0.1	2	°C
Hd Rg	55	Hd Rg	55	R/W	Lower Limit for Differential Operating Set point of the 3-Way Valve	+10	-99.9	+99.9	°C
Hd Rg	56	Hd Rg	56	R/W	Higher Limit for Differential Operating Set point of the 3-Way Valve	+35	-99.9	+99.9	°C
Hd Rg	62	Hd Rg	62	R/W	Operating Set point	+18	+10	+25	°C
Hd Rg	82	Hd Rg	82	R/W	Operating Set Point in Differential Mode	-2	-10	+10	°C
Hd Rg	5065	Hd Rg	192	R/W	Operating Mode [0 → Absolute Mode; 1 → Summer Compensation; 2 → Differential]	0	0	2	-
In Rg	5066	In Rg	193	R	Opening Status of the 3-Way Valve	-	0	100	%

Tab. 36: List of supervised variables

12 Appendix

EN

Modbus TCP/IP		Modbus BMS2		R/W	Description	Value			
Type	Idx	Type	Idx			DEF	MIN	MAX	UoM
Hd Rg	5086	Hd Rg	213	R	Opening Status of the HGBP Valve	-	0	100	%

Tab. 36: List of supervised variables

pCOWeb

- D → Digital Variable
- A → Analog Variable
- I → Integer Variable

Modbus

- In St → Input Status
- Hd Rg → Holding Register
- In Rg → Input Register
- Co St → Coil Status

12.5 Technical specifications

Designation	Unit	Model No.			
		SK 3335930	SK 3335940	SK 3335950	SK 3335960
Rated voltage/Rated frequency	V/Hz	400, 3~, 50 460, 3~, 60			
Rated current 50 Hz/60 Hz	A	9.4/8.8	10.2/11.1	12.9/12.6	20.4/20.9
Rated power P_{el} 50 Hz/60 Hz	kW	4.91/5.92	6.41/7.42	7.11/8.82	10.89/13.49
Total cooling capacity at $T_w = 18\text{ °C}$, $T_a = 35\text{ °C}$, 50 Hz/60 Hz (to DIN EN 14511)	kW	7.8/8.4	11.7/12.7	15.6/17	19.4/21.2
EER at $T_w = 18\text{ °C}$, $T_a = 35\text{ °C}$, 50 Hz/60 Hz (excluding power consumption of pump)		2.6/2.3	2.7/2.4	2.7/2.4	2.3/1.9
Dimensions (W x D x H)	mm	808 x 608 x 2238			
Operating temperature range	°C	+10...+43			
Refrigerant		R410A			
- Identification	-				
- Charge	g	1100	1250	1400	2200
GWP	-	2088			
CO ₂ e	t	3.8	4.3	4.8	7.5
Air throughput of the fans 50 Hz/60 Hz	m ³ /h	6000/7200			
Temperature hysteresis	K	±1			
Operating temperature range of cooling medium	°C	+10...+25			
Water connections		2 x 1" internal thread			
Pump pressure 50 Hz/60 Hz	bar	2.5/2.5			2.2/3.2
Nominal volumetric flow (pump) 50 Hz/ 60 Hz	l/min	30/47	30/55	35/63	43/76
Power consumption of cooling medium pump, 50 Hz/60 Hz	kW	0.67/1.06	0.67/1.06	0.67/1.06	1.35/1.93
Cooling medium tank material		PE plastic			

Tab. 37: Technical specifications

Designation	Unit	Model No.			
		SK 3335930	SK 3335940	SK 3335950	SK 3335960
Tank volume	l	75			
IP code		IP44			
Sound power level Lp (open air, distance 1 m, height 1 m, standard pump)	dB (A)	75.6			
Weight (as delivered)	kg	248	282	282	295
Operating weight	kg	323	357	357	370

Tab. 37: Technical specifications

12.6 Device drawings

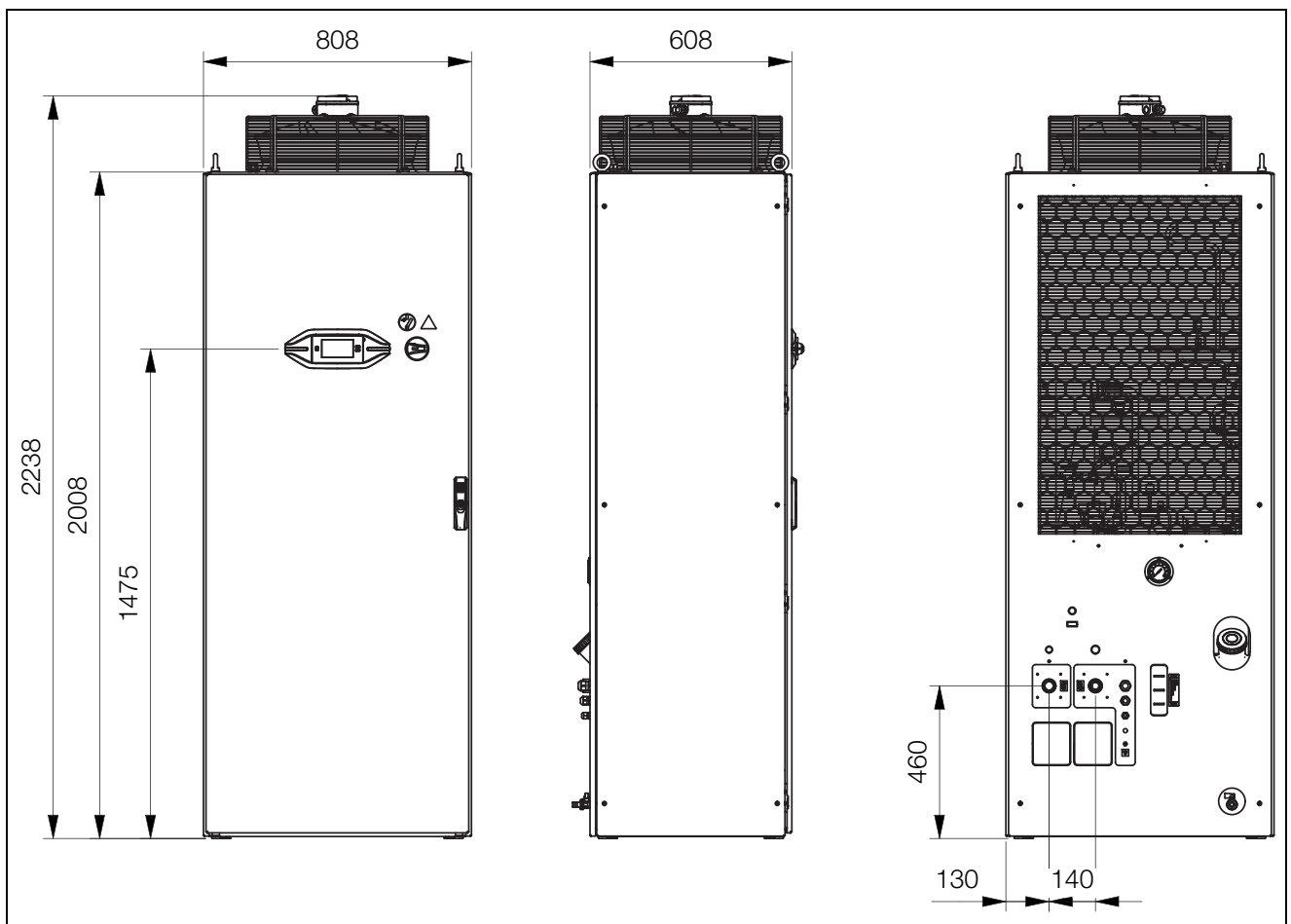

Fig. 36: Device drawings

12.7 Declaration of Conformity

Vereinfachte EU-Konformitätserklärung / Simplified EU Declaration of Conformity



Wir, / We,

Rittal GmbH & Co. KG • Auf dem Stützelberg • 35745 Herborn

Erklären, dass die Produkte / declare that the products

Serienbezeichnung / Serial name:

TTC 3 VX 25

Handelsbezeichnung / Commercial part no.:

SK 3335930 SK 3335940 SK 3335950 SK 3335960

folgender Richtlinie entsprechen: / conform to the following Directive

2006/42/EC Machinery Directive

Weitere Richtlinien: / Additional Directives:

2014/30/EU EMC Directive

2014/68/EU Pressure Equipment Directive

Herborn, 31.05.2022

Rittal GmbH & Co. KG
Auf dem Stützelberg
35745 Herborn

Bei einer nicht mit uns abgestimmten Änderung des Produkts verliert diese EU-Konformitätserklärung ihre Gültigkeit.
In case of any amendments to the assembly not explicitly agreed with us, this EU Declaration of Conformity shall be invalidated.

SCHALTSCHRÄNKE

STROMVERTEILUNG

KLIMATISIERUNG

IT-INFRASTRUKTUR

SOFTWARE & SERVICE

FRIEDHELM LOH GROUP

2022 - 000026 – 01

Seite 1 von 1

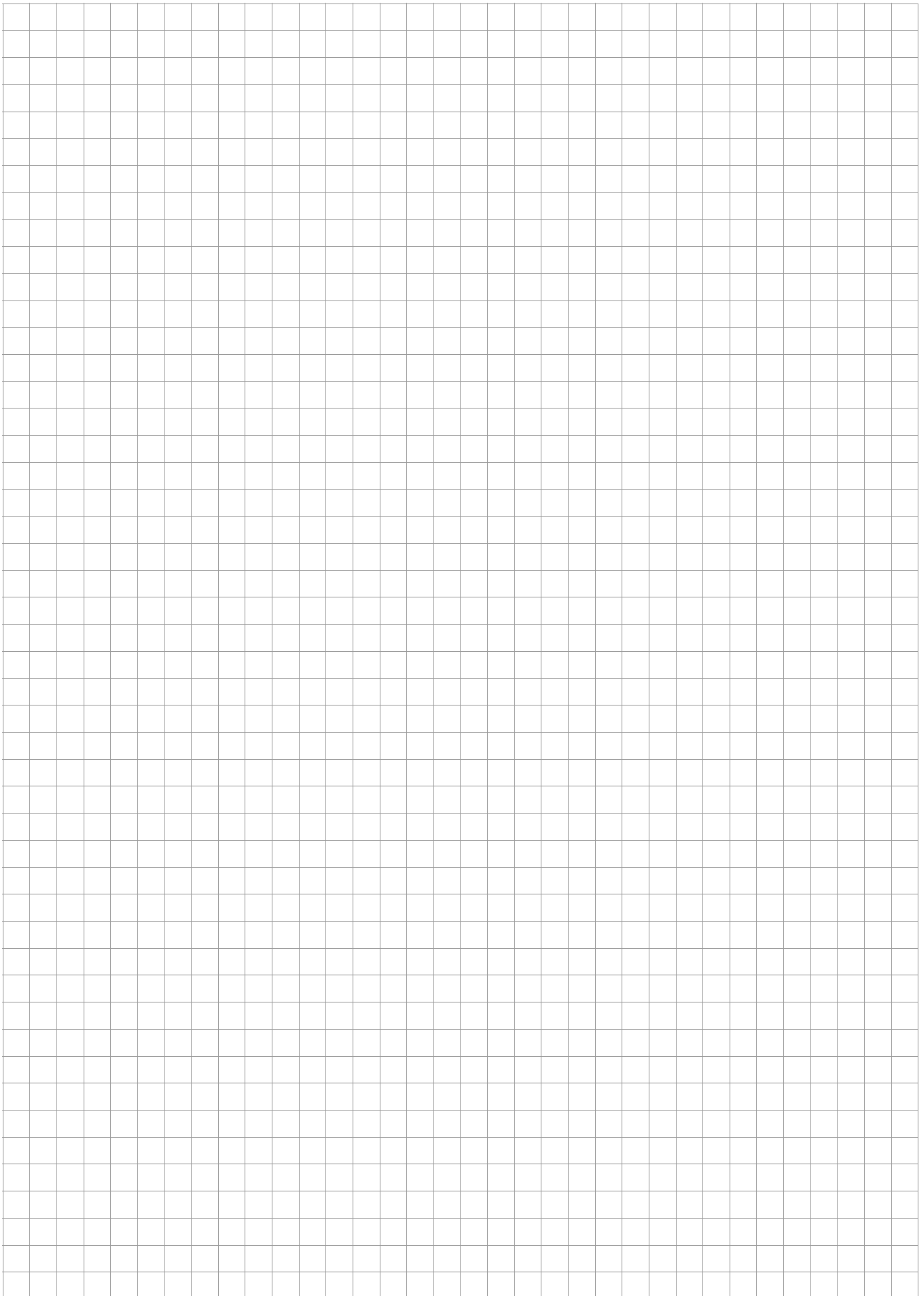

Rittal – The System.

Faster – better – everywhere.

- Enclosures
- Power Distribution
- Climate Control
- IT Infrastructure
- Software & Services

You can find the contact details of all Rittal companies throughout the world here.



www.rittal.com/contact

RITTAL GmbH & Co. KG
Auf dem Stuetzelberg · 35745 Herborn · Germany
Phone +49 2772 505-0
E-mail: info@rittal.de · www.rittal.com

04.2022 / D-0000-000003086-00-EN

ENCLOSURES

POWER DISTRIBUTION

CLIMATE CONTROL

IT INFRASTRUCTURE

SOFTWARE & SERVICES

FRIEDHELM LOH GROUP

