

**Rittal – The System.**

Faster – better – everywhere.

# Technical aspects of enclosures

Data and facts



# Publisher's foreword

---



Dear readers,

It is a great pleasure to be able to offer you this expert technical guide to the field of enclosure technology.

Switchgear represents the backbone of all technical infrastructures. In our increasingly electrified and digitalised society, it is in the meantime both omnipresent and indispensable.

And however trivial the function of an enclosure may appear at first sight, it has actually become more and more sophisticated and complex over the past decades. Enclosures must today satisfy a diverse set of exacting and sometimes contradictory demands deriving from the site conditions and the specific intended function, as well as further aspects of the installation and maintenance processes.

Such complexity can only be addressed by correspondingly informed experts. Efficient and standard compliant enclosure manufacture calls for competent knowledge. Knowledge which is increasingly rare in many markets around the world.



---

With this technical guide, we would like to provide you, our readers, with an expert knowledge base in uniquely compact form, and in this way to help you gain a competitive advantage in your respective markets.

We are fully aware that questions will arise which go beyond the scope of this reference work. Accordingly, our whole team of Rittal experts stands ready to advise you at any time and would be glad to answer any technical questions which you may have.

We hope that you will enjoy exploring the world of enclosure manufacture.

Ulrich Engenhardt is Chief Business Units Officer  
at Rittal GmbH & Co. KG

### **The Rittal technology library, volume 3**

Published by Rittal GmbH & Co. KG  
Herborn, September 2023

All rights reserved.  
No duplication or distribution  
without our express consent.

The publisher and authors have taken the utmost care in the preparation of all text and visual content. However, we cannot be held liable for the correctness, completeness and up-to-dateness of the content. Under no circumstances will the publisher and authors accept any liability whatsoever for any direct or indirect damages resulting from the application of this information.

Copyright: © 2023 Rittal GmbH & Co. KG  
Printed in Germany

3. Completely revised new edition  
September 2023

Produced by:  
Rittal GmbH Austria  
Andreas Hrzina

# The authors – Hartmut Lohrey and Andreas Hrzina

---



## **The author Hartmut Lohrey**

Hartmut Lohrey was Head of the Marketing Training/Support department at Rittal from 2001 to 2021. Together with his team, he planned and organised a broad programme of technical product and application training, as well as advising customers and end users in all technical matters relating to the company's standard products.

Hartmut Lohrey was a member of various national and international standardisation committees, and represented Rittal in the German Association for EMC Technology (DEMVT).



## **Production, Andreas Hrzina**

Throughout the production of this book, we repeatedly asked ourselves whether a reference work in printed form is actually in keeping with the times. Not least in an age dominated by digital media, and in a phase in which we are already witnessing artificial intelligence in so many areas of daily life. It may seem rather unusual to some. But we decided in favour of the analogue form. To ensure that our decision was also in line with your wishes, we first approached our customers and customer advisors and asked about current preferences. And the feedback was conclusive: Traditional methods of information distribution still play an important role in areas where hands-on work prevails, especially in production centres and workshops, and access to digital media cannot be taken for granted.

This book is intended as a permanently available source of knowledge on all aspects of enclosure manufacture, both in the classroom and in practical settings.

Andreas Hrzina is Head of Marketing for South-East Europe, Head of Product Management and an authorised signatory for the company at Rittal GmbH in Austria.

# Contents

---

Sizes, units, formulae, standards	Page
Sizes .....	8
Formulae .....	12
Standards .....	20

## Selection of operating equipment

Installation materials .....	28
Cables .....	31
Bars .....	40
Fuses .....	47
Motors .....	53
Basic principles .....	54
Transport .....	67

## Application areas

Machines .....	72
Switchgear .....	78
Special topics .....	84
Worldwide .....	95

## Labelling

Labelling of components .....	102
Labelling in plans .....	108
Labelling for test purposes .....	121

## Indexes

Index .....	122
Bibliography .....	124
My Rittal online shop .....	125
Software solutions from Rittal and Eplan .....	126

# Rittal – The System.

Faster – better – everywhere.



# Sizes, units, formulae, standards

---

Sizes	Page
Sizes and units .....	8
General technical factors .....	10
Formulae	
Selection of electrical engineering formulae .....	12
Standards	
Important regulations and standards for enclosures .....	20
Important standards for data communications and telecommunications .....	21
Overview of standards 482.6 mm (19")/metric .....	22

# Sizes

## Sizes and units

Length Area	Metres m Square metres m <sup>2</sup> , 1 a = 100 m <sup>2</sup> , 1 ha = 100 a, 1 km <sup>2</sup> = 100 ha
Volume	Cubic metres m <sup>3</sup> , litres l
Mass, weight	Kilograms kg; grams g; tonnes t
Force, force due to weight Pressure	Newtons N, 1 N = 1 kgm/s <sup>2</sup> Bar bar, Pascal Pa, 1 bar = 10 <sup>5</sup> Pa, 1 Pa = 1 N/m <sup>2</sup>
Time Frequency Speed Acceleration	Seconds s, minutes min, hours h, days d, years a Hertz Hz, 1 Hz = 1/s Metres per second m/s Metres per second squared m/s <sup>2</sup>
Work, energy Quantity of heat Power	Joules J, watt seconds Ws, kilowatt hours kWh 1 J = 1 Ws = 1 Nm Watts W (active power), 1 W = 1 Nm/s = 1 J/s Volt amperes VA (apparent power) Var var (reactive power)
Temperature Temperature difference	Kelvin K, degrees Celsius °C, 0 °C = 273.15 K 1 K = 1 °C
Luminous intensity Luminance Luminous flux Illuminance	Candela cd Candela per square metre cd/m <sup>2</sup> Lumen lm Lux lx
Current Voltage Resistance Conductivity Quantity of electricity Capacity Electrical field strength Electrical flux density Current density	Amperes A Volts V Ohm Ω, 1 Ω = 1 V/A Siemens S, 1 S = 1 Ω <sup>-1</sup> Coulombs C, ampere seconds As, ampere hours Ah, 1 C = 1 As Farads F, 1 F = 1 As/V Volts per metre V/m Coulombs per square metre C/m <sup>2</sup> Amperes pro mm <sup>2</sup> A/mm <sup>2</sup>
Magnetic field strength Magnetic flux Magnetic flux density Induction, inductance	Amperes per metre A/m Weber Wb, volt-seconds Vs, 1 Wb = 1 Vs Tesla T, 1 T = 1 Vs/m <sup>2</sup> Henry H, 1 H = 1 Vs/A



# Sizes

## Basic units

According to the international system of units, the basic units are the metre m, the kilogram kg, the second s, the ampere A, the kelvin K, the candela cd and the mole mol. All other units are derived from these.

**1 kilogramm** (1 kg) is the mass of the international prototype of the kilogram which is kept at the Bureau International des Poids et Mesures in Sèvres near Paris.

**1 metre (1 m)** is the length of the path travelled by light in a vacuum during a time interval of  $1/299,792,458$  of a second.

**1 second** (1 s) is  $9,162,631,770$  times the period of the radiation corresponding to the transition between the two hyperfine structure levels of the fundamental state of atoms of the nuclide  $^{133}\text{Cs}$ .

**1 kelvin** (1 K) is the  $1/273.15$ th part of the thermodynamic temperature of the triple point of water.

**1 candela** (1 cd) is the luminous intensity in a given direction of a source that emits monochromatic radiation of frequency  $540 \cdot 10^{12}$  hertz and has a radiant intensity in that same direction of  $1/683$  watt per steradian.

**1 ampere** (1 A) is the intensity of a constant electric current which, if maintained in two straight parallel conductors of infinite length, of negligible circular cross-section and placed 1 metre apart in vacuum, would produce a force equal to  $2 \times 10^{-7}$  newtons per metre of length between these conductors.

**1 mole** (1 mol) is the amount of substance in a system that contains as many elementary entities as there are atoms in  $12/1000$  kilogram of nuclide  $^{12}\text{C}$ .

## Derived units

**1 volt** (1 V) is equal to the electrical current between two points in a thread-like, homogeneous conductor of even temperature carrying a current of 1 A when the power dissipated between the points is one watt. The resistance of this conductor is  $1 \Omega$ .

**1 joule** (1 J) is equivalent to the work done when a force of one newton moves its point of application one metre in the direction of the force.

**1 watt** (1 W) is equal to one joule (1 J) of work performed per second.

# Sizes

## Decimal parts and multiples of units

Exponent	Prefix	Symbol
$10^{-18}$	atto	a
$10^{-15}$	femto	f
$10^{-12}$	pico	p
$10^{-9}$	nano	n
$10^{-6}$	micro	$\mu$
$10^{-3}$	milli	m
$10^{-2}$	centi	c
$10^{-1}$	deci	d

Exponent	Prefix	Symbol
10	deca	da
$10^2$	hecto	h
$10^3$	kilo	k
$10^6$	mega	M
$10^9$	giga	G
$10^{12}$	tera	T
$10^{15}$	peta	P
$10^{18}$	exa	E

## General technical factors

### International system of units (SI)

Basic factors Physical factor	Symbol	Basic SI unit	Other SI units
Length	l	m (metres)	km, dm, cm, mm, $\mu\text{m}$ , nm, pm
Mass	m	kg (kilograms)	Mg, g, mg, $\mu\text{g}$
Time	t	s (seconds)	ks, ms, $\mu\text{s}$ , ns
Electrical current intensity	I	A (amperes)	kA, mA, $\mu\text{A}$ , nA, pA
Thermodynamic temperature	T	K (kelvins)	–
Amount of substance	n	mole (mol)	Gmol, Mmol, Kmol, mmol, $\mu\text{mol}$
Luminous intensity	$I_v$	cd (candela)	Mcd, kcd, mcd

# Sizes

## Conversion factors for old units to SI units

Size	Old unit	Precise SI unit	SI unit ~
Force	1 kp	9.80665 N	10 N
	1 dyn	$1 \cdot 10^{-5}$ N	$1 \cdot 10^{-5}$ N
Moment of force	1 mkp	9.80665 Nm	10 Nm
Pressure	1 at	0.980665 bar	1 bar
	1 Atm = 760 Torr	1.01325 bar	1.01 bar
	1 Torr	1.3332 mbar	1.33 mbar
	1 mWS	0.0980665 bar	0.1 bar
	1 mmWS	0.0980665 mbar	0.1 mbar
	1 mmWS	9.80665 Pa	10 Pa
Strength, voltage	$1 \frac{\text{kp}}{\text{mm}^2}$	$9.80665 \frac{\text{N}}{\text{mm}^2}$	$10 \frac{\text{N}}{\text{mm}^2}$
Energy	1 mkp	9.80665 J	10 J
	1 kcal	4.1868 kJ	4.2 kJ
	1 erg	$1 \cdot 10^{-7}$ J	$1 \cdot 10^{-7}$ J
Power	$1 \frac{\text{kcal}}{\text{h}}$	$4.1868 \frac{\text{kJ}}{\text{h}}$	$4.2 \frac{\text{kJ}}{\text{h}}$
	$1 \frac{\text{kcal}}{\text{h}}$	1.163 W	1.16 W
	1 PS	0.735499 kW	0.74 kW
Heat transfer coefficient	$1 \frac{\text{kcal}}{\text{m}^2/\text{h}}$	$4.1868 \frac{\text{kJ}}{\text{m}^2 \text{ h K}}$	$4.2 \frac{\text{kJ}}{\text{m}^2 \text{ h K}}$
	$1 \frac{\text{kcal}}{\text{m}^2/\text{h}}$	$1.163 \frac{\text{W}}{\text{m}^2 \text{ K}}$	$1.16 \frac{\text{W}}{\text{m}^2 \text{ K}}$

# Formulae

## Selection of electrical engineering formulae

### Ohm's law

$$V = R \cdot I$$

$$I = \frac{V}{R}$$

$$R = \frac{V}{I}$$

### Line resistance

$$R = \frac{L}{\gamma \cdot A}$$

$$R = \frac{\rho \cdot L}{A}$$

Copper

$$\gamma = 56 \text{ m}/\Omega \text{ mm}^2$$

$$\frac{1}{\gamma} = \rho = 0.0178 \text{ } \Omega \text{ mm}^2/\text{m}$$

Aluminium

$$\gamma = 36 \text{ m}/\Omega \text{ mm}^2$$

$$\frac{1}{\gamma} = \rho = 0.0278 \text{ } \Omega \text{ mm}^2/\text{m}$$

L = length of conductor (m)

$\rho$  = spec. resistance ( $\Omega \text{ mm}^2/\text{m}$ )

$\gamma$  = conductivity ( $\text{m}/\Omega \text{ mm}^2$ )

A = cross-section of conductor ( $\text{mm}^2$ )

### Series connection

$$R_g = R_1 + R_2 + \dots + R_n$$

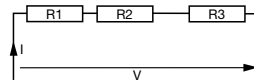

### Parallel connection

For two resistors, the following applies:

$$R = \frac{R_1 \cdot R_2}{R_1 + R_2}$$

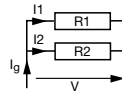

$$\frac{I_1}{I_2} = \frac{R_2}{R_1}$$

For three or more resistors, the following applies:

$$\frac{1}{R} = \frac{1}{R_1} + \frac{1}{R_2} + \frac{1}{R_3} + \dots + \frac{1}{R_n}$$

$$G = G_1 + G_2 + G_3 + \dots$$

$$G = \frac{1}{R} \quad I_g = \Sigma I \quad I_g = V \cdot G$$

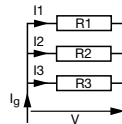

# Formulae

## Voltage drop

DC current

$$V_D = \frac{2 \cdot L \cdot P}{\gamma \cdot A \cdot V}$$

$$V_D = \frac{2 \cdot L \cdot I}{\gamma \cdot A}$$

$V_D$  = voltage drop  
 $V$  = mains voltage  
 $A$  = cross-section  
 $I$  = total current  
 $P$  = total power  
 $L$  = length of conductor  
 $\gamma$  = conductivity

AC current

$$V_D = \frac{2 \cdot L \cdot P}{\gamma \cdot A \cdot V}$$

$$V_D = \frac{2 \cdot L \cdot I \cdot \cos \varphi}{\gamma \cdot A}$$

Example:

$L$  = 100 m  
 $A$  = 2.5 mm<sup>2</sup>  
 $\gamma$  = 56 m/Ω mm<sup>2</sup>  
 $I$  = 10 A

Rotary current motor

$$V_D = \frac{L \cdot P}{\gamma \cdot A \cdot V}$$

$$V_D = \frac{2 \cdot L \cdot I}{\gamma \cdot A}$$

$$V_D = \frac{2 \cdot 100 \cdot 10}{56 \cdot 2.5}$$

$$V_D = 14.3 \text{ V}$$

## Resistance in an AC circuit

Inductive resistance

$$X_L = \omega \cdot L$$

$$I = \frac{V}{X_L}$$

$$\omega = 2 \cdot \pi \cdot f$$

$$I = \frac{V}{\omega \cdot L}$$

$X_L$  = inductive resistance (Ω)

$L$  = inductance (H), coil

$I$  = current (A)

$\omega$ ,  $f$  = angular frequency, frequency (1/s)

Capacitive resistance

$$X_C = \frac{1}{\omega \cdot C}$$

$$I = \frac{V}{X_C}$$

$$\omega = 2 \cdot \pi \cdot f$$

$X_C$  = capacitive resistance (Ω)

$C$  = capacity (F), condenser

$I$  = current (A)

$\omega$ ,  $f$  = angular frequency, frequency (1/s)

# Formulae

## Various values of sinusoidal quantities

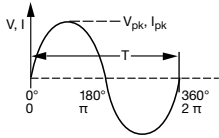

$$i = I_{pk} \cdot \sin \omega t$$

$$v = V_{pk} \cdot \sin \omega t$$

$$\omega = 2 \cdot \pi \cdot f$$

$$V_{rms} = \frac{V_{pk}}{\sqrt{2}}$$

$$f = \frac{1}{T}$$

$$I_{rms} = \frac{I_{pk}}{\sqrt{2}}$$

$$T = \frac{1}{f}$$

$$V_{am} = 0.637 \cdot V_{pk}$$

$$I_{am} = 0.637 \cdot I_{pk}$$

### Voltage characteristic

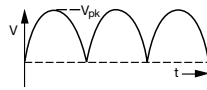
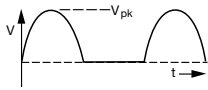

### Half-wave rectification

$$V_{am} = 0.318 \cdot V_{pk}$$

$$V_{rms} = 0.5 \cdot V_{pk}$$

### Full-wave rectification

$$V_{am} = 0.637 \cdot V_{pk}$$

$$V_{rms} = 0.707 \cdot V_{pk}$$

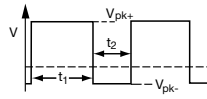
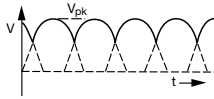

### 3-phase rectification

$$V_{am} = 0.827 \cdot V_{pk}$$

$$V_{rms} = 0.841 \cdot V_{pk}$$

### Square-wave voltage characteristic

$$V_{am} = \frac{V_{pk+} \cdot t_1 + V_{pk-} \cdot t_2}{t_1 + t_2}$$

$$V_{rms} = \sqrt{\frac{V_{pk+}^2 \cdot t_1 + V_{pk-}^2 \cdot t_2}{t_1 + t_2}}$$

$i, v$  = current values (A, V)

$I_{pk}, V_{pk}$  = peak values (A, V)

$I_{rms}, V_{rms}$  = root-mean-square values (A, V)

$I_{am}, V_{am}$  = arithmetic mean values (A, V)

$f$  = frequency (1/s)

$\omega$  = angular frequency (1/s)

$T$  = duration of a period (s)

# Formulae

## On/off operations

With inductivities

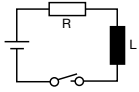

$$\tau = \frac{L}{R}$$

$$i = I \cdot \left(1 - e^{-\frac{t}{\tau}}\right)$$

Current after switching on

$$i = I \cdot e^{-\frac{t}{\tau}}$$

Current after switching off

With capacities

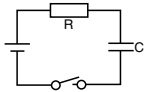

$$\tau = R \cdot C$$

$$i = I \cdot e^{-\frac{t}{\tau}}$$

Charging current

$$v = V \cdot \left(1 - e^{-\frac{t}{\tau}}\right)$$

Charging voltage

$$v = V \cdot e^{-\frac{t}{\tau}}$$

Discharge voltage

$\tau$  = time constant (s)

$t$  = time (s)

$e$  = basis of natural logarithms

$v, i$  = instantaneous values of current and voltage (V, A)

$V, I$  = initial and final values of current and voltage (V, A)

## Electrical power of motors

Power supplied

Current consumption

DC current

$$P_1 = V \cdot I \cdot \eta$$

$$I = \frac{P_1}{V \cdot \eta}$$

AC current

$$P_1 = V \cdot I \cdot \eta \cdot \cos \varphi$$

$$I = \frac{P_1}{V \cdot \eta \cdot \cos \varphi}$$

$P_1$  = mechanical power supplied at the motor shaft as per rating plate

$P_2$  = electrical power input

Efficiency  $\eta = \frac{P_1}{P_2} \cdot (100\%)$

$$P_2 = \frac{P_1}{\eta}$$

# Formulae

## Resonance in an AC circuit

Series resonant circuit

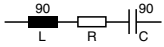

$$f_{\text{res}} = \frac{1}{2 \cdot \pi \cdot \sqrt{L \cdot C}}$$

$$Q = \frac{1}{R} \sqrt{\frac{L}{C}}$$

$$b = \frac{f_{\text{res}}}{Q}; b = \frac{R}{X_{\text{res}}} f_{\text{res}}$$

$$Z = \sqrt{R^2 + \left( \omega L - \frac{1}{\omega C} \right)^2}$$

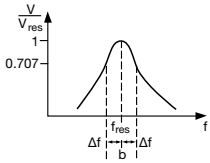

$f_{\text{res}}$  = resonance frequency (1/s)

$Q$  = circuit quality

$G = \frac{1}{R}$  = conductance

Parallel resonant circuit

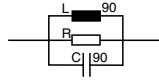

$$f_{\text{res}} = \frac{1}{2 \cdot \pi \cdot \sqrt{L \cdot C}}$$

$$Q = R \sqrt{\frac{C}{L}}$$

$$b = \frac{f_{\text{res}}}{Q}; b = \frac{G}{B_{\text{res}}} f_{\text{res}}$$

$$Z = \frac{1}{\sqrt{G^2 + \left( \frac{1}{\omega L} - \omega C \right)^2}}$$

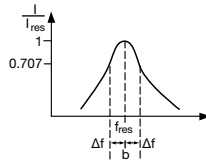

$b$  = bandwidth

$Z$  = impedance ( $\Omega$ )

$B$  = susceptance

## Electrical power

DC current

$$P = V \cdot I$$

AC current

$$P = V \cdot I \cdot \cos \varphi$$



# Formulae

## Calculation of power in an AC circuit

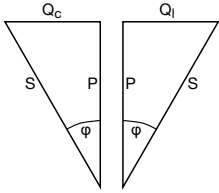

Capacitive ← I → Inductive

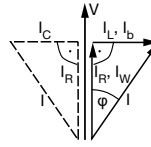
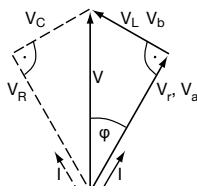

$$P = S \cdot \cos \varphi$$

$$Q = S \cdot \sin \varphi$$

$$S = \sqrt{P^2 + Q^2}$$

$$S = V \cdot I$$

$$\cos \varphi = \frac{R}{Z}$$

$$\sin \varphi = \frac{X}{Z}$$

$$Z = \sqrt{R^2 + X^2}$$

$$V_a = V \cdot \cos \varphi$$

$$V_r = V \cdot \sin \varphi$$

$$V = \sqrt{V_a^2 + V_r^2}$$

$$I_a = I \cdot \cos \varphi$$

$$I_r = I \cdot \sin \varphi$$

$$I = \sqrt{I_a^2 + I_r^2}$$

S = apparent power (VA)

P = active power (W)

Q = reactive power (VA)

Z = impedance ( $\Omega$ )

R = active resistance ( $\Omega$ )

X = reactance ( $\Omega$ )

$V_a, V_r$  = active, reactive voltage (V)

$I_a, I_r$  = active, reactive current (A)

$\sin \varphi, \cos \varphi$  = power factors

# Rittal – The System.

Faster – better – everywhere.



# Your benefits

---

As a system provider, Rittal is the world's leading supplier of innovative enclosure technology. Rittal meets very high standards of security, ergonomics, energy and cost efficiency.

**Faster** – Software tools for efficient engineering and a huge range of products available for immediate delivery

**Better** – A comprehensive range of system accessories for individual installation and fast assembly

**Everywhere** – A contiguous global delivery and service network



# Standards

## Important regulations and standards for enclosures

Rittal created a market breakthrough with the idea of standardising enclosures.

By using models with set dimensions, produced extremely cost-effectively in large batches, Rittal offers astounding price benefits and exemplary delivery capabilities, with over 100 well-stocked depots worldwide.

Today, Rittal enclosure systems, with their modern, user-friendly design, enjoy a reputation as pace-setters within the industry. Reliable quality and technical dependability are top of the list in Rittal's spectrum of services.

Rittal enclosures meet all relevant standards, regulations and guidelines, such as:

Standards	Topic
DIN EN 62 208	Empty enclosures for low-voltage switchgear assemblies
IEC 60 297-3-100	Basic dimensions of front panels, subracks, chassis, racks and cabinets
DIN 41 488, Part 2	Low-voltage switchgear
DIN 43 668	Keys for cells or enclosure doors of electrical switchgear (double-bit) Size 3: Low voltage installations Size 5: High and low-voltage installations
DIN 7417	Piped keys with square sockets, size 7 for shipbuilding
DIN 43 656	Colours for indoor electrical switchgear

The German Energy Management Act states that: **“Electrical power installations and power-consuming equipment shall be set up and maintained properly, i.e. in accordance with the recognised technical rules, such as the provisions of the Association of German Electrical Engineers (VDE).”** As systems below 1000 V are so widespread and diverse, special significance is attached to VDE 0100 “Provisions for the construction of heavy current installations with rated voltages of less than 1000 V”.

Other regulations which must be observed in the case of heavy current installations are the Technical Connection Conditions of the electricity supply companies, and in the case of telecommunications and aerial installations, VDE 0800 Regulations for Telecommunications Installations and VDE 0855 Provisions for Aerial Installations. New installations should have provision for extension and should be economical. In addition to the Connection Conditions, important notes in this respect can be found in the **DIN standards** published by the German Institute for Standardization (**DIN**).

# Standards

## Important standards for data communications and telecommunications

### List of general standards

DIN EN 61 000-6-3 (VDE 0839, Part 6-3)	Electromagnetic compatibility (EMC) Generic standards – Emission standard for residential, commercial and light-industrial environments
DIN EN 61 000-6-1 (VDE 0839, Part 6-1)	Electromagnetic compatibility (EMC) Generic standards – Immunity for residential, commercial and light-industrial environments
DIN EN 50 288-2 (VDE 0819, Part 5)	Framework specifications for shielded cables up to 100 MHz
DIN 55016 (VDE 0877-16)	Specification for radio disturbance and immunity measuring apparatus and methods
DIN EN 60 825-2 (VDE 0837, Part 2)	Safety of laser products – Part 2: Safety of optical fibre communications systems

### Installation of terminal equipment

VDE 0845-6-1	Influence Of High Voltage Systems On Telecommunication Systems
DIN EN 50 310 (VDE 0800, Part 2-310)	Application of equipotential bonding and earthing in buildings with information technology equipment

### Types and use of communication cables



DIN VDE 0815	Wiring cables for telecommunication and data processing systems
DIN VDE 0891-1	Use of cables and insulated leads for telecommunications and information processing installations
DIN EN 60 794 (VDE 0888-100-1)	Fibre-optic cables
DIN EN 50 174-2 (VDE 0800, Part 174-2)	Information technology. – Cabling installation. Installation planning and practices inside buildings

# Standards

## Overview of standards 482.6 mm (19")/metric

### ETS 300 119-3

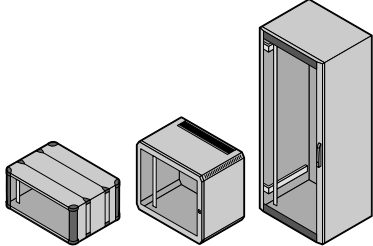
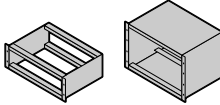
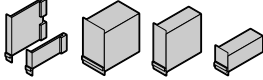
Below, we outline the basic system for the mechanical configuration of electronic devices and their installation in data and telecommunications enclosures and cases. There are two international standards series available.

<b>482.6 mm (19") installation system</b>	<b>Metric system</b>	
to IEC 60 297 (482.6 mm system)	to IEC 60 917 (25 mm system)	
IEC 60 297-3-100 DIN EN 60 297-3-100	IEC 60 917-2-1 Enclosures Housings	
IEC 60 297-3-100 DIN EN 60 297-3-100	IEC 60 917-2-2 Subbracks System enclosures	
IEC 60 297-3-100 DIN EN 60 297-3-100	IEC 60 917-2-2 Board type plug-in units Box type plug-in units	
IEC 60 297-3-104 IEC 60 603-3-104 DIN 41 494, Part 8	IEC 61 076-4-100 Cards Connectors Front units IEC 60 917-2-2 Backplanes	

# Standards

## Pitch pattern of holes

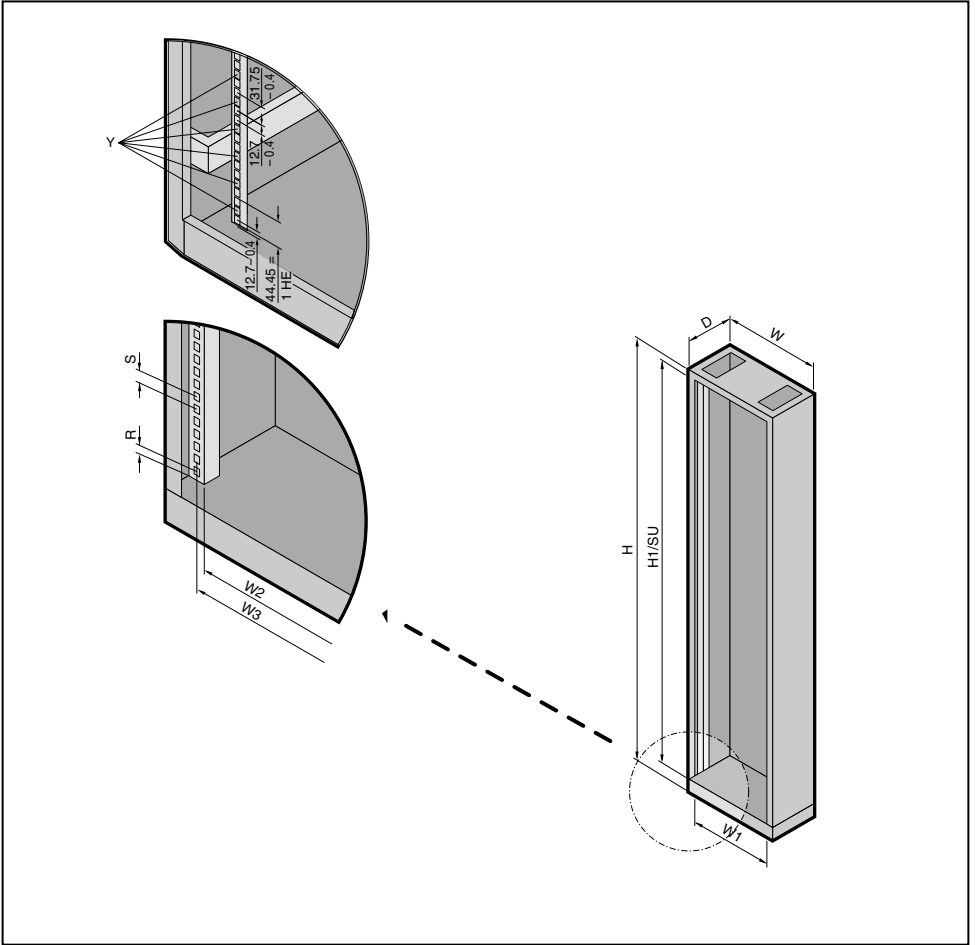

Y = Pitch pattern of holes to IEC 60 297-3-100  
additionally with universal punchings to EIA-RS-310-D

# Standards

## Section showing standard dimensions

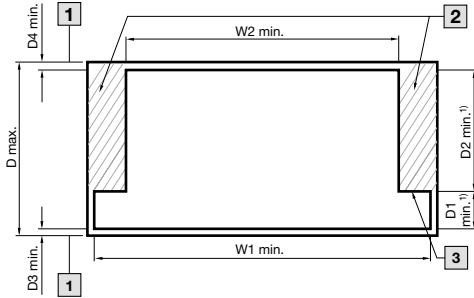

- 1 Space for door or trim panel
  - 2 Space for external cable entry
  - 3 Rail level
- 1) Space for possible accessories

Dimensions for universal racks			
H	Height	1800/2000/2200	1800/2000/2200
W	Width	600	600
D	Depth	300	600
H1	Mounting height of the assembly	1600/1800/2000	1600/1800/2000
SU		66/74/82	66/74/82
W1	Installation width for the assembly	535	535
W2	Distance between mounting angles	500	500
W3	Hole-centre distance	515	515
D1	Mounting depth for the assembly (front)	40	75
D2	Mounting depth for the assembly (rear)	240	470
R	Mounting position	12.5	12.5
S	Hole distance (centered)	25	25
D3	Mounting depth for the door or trim panel (front)	10	25
D4	Mounting depth for the door or trim panel (rear)	5	25



# Standards

## EIA-310-D (Cabinets, Racks, Panels, and Associated Equipment)

The EIA-310-D standard sets out general design requirements for cabinets, panels, racks and subracks. Essentially, these are the inner and outer dimensions in order to ensure exchangeability of the accommodation systems.

For enclosures and open frames, the standard describes three types:

All Rittal IT enclosures meet the EIA-310-D standard as Type A enclosures.

### ■ Type A

Without restrictions to the external dimensions width, height, depth, with 25 mm pitch patterns, the internal widths and heights should conform to IEC.

### ■ Type B

Restriction of the external and internal dimensions, all accessories (walls + mounting parts, roof + feet/castors, doors + locks) must remain within the specified dimensions.

### ■ Type C

Restriction only in relation to the width dimensions; deviations in the height and depth for the accessories are admissible.

# Rittal – The System.

Faster – better – everywhere.



# Selection of operating equipment

---

	Page
Installation materials	
Cable glands to DIN EN 50 262 .....	28
Internal and external diameters of conduits .....	29
Electrical wiring system: Cables in cable ducts .....	30
<b>Cables</b>	
Insulated heavy current cables .....	31
Flammability test for plastics to UL 94 .....	32
External diameters of lines and cables .....	36
<b>Bars</b>	
Resistance of copper busbars .....	40
Continuous currents for busbars .....	41
Calculation of heat loss in busbars .....	42
Current correction for Cu busbar systems .....	43
<b>Fuses</b>	
Overcurrent protection devices .....	47
Categories of low-voltage fuses .....	50
Heat loss .....	51
<b>Motors</b>	
Rated motor currents of three-phase motors .....	53
<b>Basic principles</b>	
Enclosure climate control .....	54
Temperature rise in enclosures .....	58
Calculation basis for enclosure climate control .....	59
Enclosure protection categories against contact, foreign bodies and water .....	62
Enclosure protection categories against external mechanical stresses .....	65
Short-circuit current terminology in three-phase systems .....	66
<b>Transport</b>	
Examples of crane transportation for Rittal enclosures .....	67

## Installation materials

### Cable glands to DIN EN 62444

Safety standard, no requirements governing the shape of the cable gland

Metric thread	Hole diameter
	+ 0.2 - 0.4
M6	6.5
M8	8.5
M10	10.5
M12	12.5
M16	16.5
M20	20.5
M25	25.5
M32	32.5
M40	40.5
M50	50.5
M63	63.5
M75	75.5

### Technical specifications for the installation of PG screwed cable glands

PG thread DIN 40 430	Nominal thread			
	Core diameter $d_1$	External diameter $d_2$	Pitch $p$	Hole diameter $d_3$
PG 7	11.28	12.50	1.27	13.0 ± 0.2
PG 9	13.35	15.20	1.41	15.7 ± 0.2
PG 11	17.26	18.60	1.41	19.0 ± 0.2
PG 13.5	19.06	20.40	1.41	21.0 ± 0.2
PG 16	21.16	22.50	1.41	23.0 ± 0.2
PG 21	26.78	28.30	1.588	28.8 ± 0.2
PG 29	35.48	37.00	1.588	37.5 ± 0.3
PG 36	45.48	47.00	1.588	47.5 ± 0.3
PG 42	52.48	54.00	1.588	54.5 ± 0.3
PG 48	57.73	59.30	1.588	59.8 ± 0.3

PG = DIN 40 430 Armoured steel conduit threads, sizes

# Installation materials

## Internal and external diameters of conduits

Nominal conduit size (type)	Plastic insulated conduits							
	Rigid insulating conduits Mechanical stresses				Flexible insulated conduits, corrugated Mechanical stress			
	Light Diameter		Medium and heavy Diameter		Medium and light Diameter		Heavy Diameter	
mm	internal mm	external mm	internal mm	external mm	internal mm	external mm	internal mm	external mm
–	8.8	10.1	12.6	15.2	9.6	13	–	–
11.0	11.6	13	16	18.6	11.3	15.8	13.5	18.6
13.5	14.2	15.8	17.5	20.4	14.3	18.7	14.2	20.4
16	16.7	18.7	19.4	22.5	16.5	21.2	16	22.5
21	19.2	21.2	24.9	28.3	–	–	22	28.3
23	25.9	28.5	–	–	23.3	28.5	–	–
29	–	–	33.6	37	29	34.5	29.8	37
36	–	–	42.8	47	36.2	42.5	38.5	47
42	–	–	49.6	54	–	–	–	–
48	–	–	54.7	59.3	47.7	54.5	–	–

Nominal conduit size (type)	Armoured steel conduit and steel conduit				
	Armoured steel conduit			Flexible steel conduit	
	Thread	Diameter		Diameter	
mm	Code	internal mm	external mm	internal mm	external mm
–	PG 9	13.2	15.2	10.8	15.2
11.0	PG 11	16.4	18.6	14	18.6
13.5	PG 13.5	18	20.4	15.6	20.4
16	PG 16	19.9	22.5	17.4	22.5
21	PG 21	25.5	28.3	23.2	28.3
23	–	–	–	–	–
29	PG 29	34.2	37	31.4	37
36	PG 36	44	47	40.8	47
42	PG 42	51	54	46.7	54
48	PG 48	55.8	59.3	51.8	59.3

# Installation materials

## Electrical wiring system: Cables in cable ducts

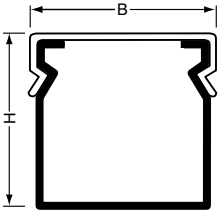

Dimensions Cable duct		Sufficient for n wires e.g. H07V-U/R/k		
H mm	B (W) mm	1 mm <sup>2</sup>	1.5 mm <sup>2</sup>	2.5 mm <sup>2</sup>
18	19	21	19	14
23	31	45	36	29
32	18	36	32	23
33	30	63	55	41
34	46	100	87	65
44	19	53	46	34
44	30	84	73	53
44	45	126	110	79
45	67	193	168	120
45	86	247	216	155
45	126	360	315	225
63	19	76	67	48
65	30	124	109	81
65	46	191	167	124
65	66	274	240	178
65	86	357	313	232
65	107	445	389	289
65	126	524	458	340
65	156	576	504	374
65	206	768	672	498
85	31	168	147	109
85	47	255	226	166
85	67	364	322	236
85	87	473	418	307
85	107	581	514	377
85	127	690	610	448

# Cables

## Insulated heavy current cables

For PVC and rubber-insulated heavy current cables, VDE regulations are harmonised with European standardisation.

The harmonised cable types receive harmonised type codes in accordance with VDE 0292. This also applies to additionally recognised national types representing an extension to the harmonised type series.

For the national types not covered by harmonisation, the previous type codes to VDE 0250 still apply.

### Type codes of the harmonised power cables

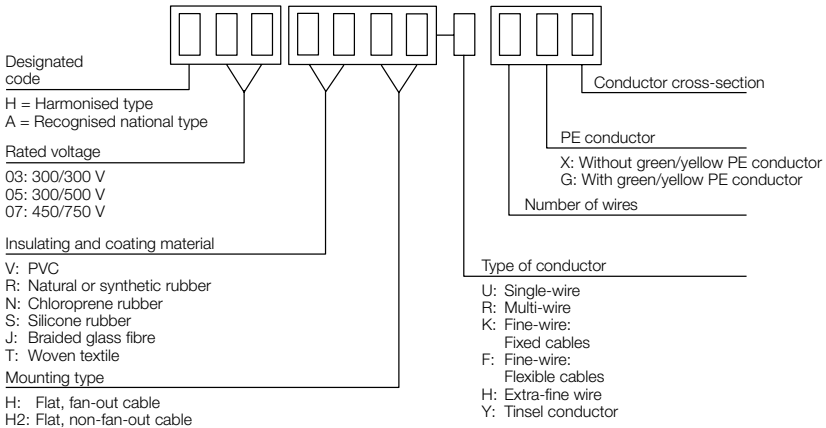

# Cables

## Flammability test for plastics to UL 94

### Test:

The flame is directed at the test piece for 10 seconds then withdrawn, and a note is made of the time taken until all flames are extinguished. The flame is then directed at the test piece for a further 10 seconds. The experiment is performed on 5 test pieces. The average values of the 5 experiments are determined.

### The materials are classified as follows:

**94 V-0:** The test piece is extinguished within 5 seconds on average. No test piece burns for longer than 10 seconds. Burning particles are not lost from any of the test pieces.

**94 V-1:** The test pieces are extinguished within 25 seconds. No test piece burns for longer than 60 seconds. Burning particles are not lost from any of the test pieces.

**94 V-2:** Like 94 V-1, but the test pieces lose burning particles during the experiment.

## Plastic-insulated cables to DIN VDE 0298-4

Designation to DIN EN 50525-1 VDE 0285-525-1	Type codes	Rated voltage U <sub>o</sub> /U	No. of wires	Nominal cross-section	Suitable for
Light twin cord	H03VH-Y	300/300	2	0.1	Dry rooms for connecting light hand-held appliances (not hot appliances); max. 1 A and maximum 2 m cable length
Twin cords	H03VH-H	300/300	2	0.5 and 0.75	Dry rooms with very low mechanical stresses (not hot appliances)
Light PVC sheathed cable (round)	H03VV-F	300/300	2 and 3	0.5 and 0.75	Dry rooms with very low mechanical stresses (light hand-held appliances)



## Cables

Designation to DIN EN 50525-1 VDE 0285-525-1	Type codes	Rated voltage Vo/V	No. of wires	Nominal cross-section	Suitable for
Medium PVC sheathed cable	H05VV-F	300/500	2 ... 5	1 ... 2.5	Dry rooms with medium mechanical stresses, for domestic appliances also in damp rooms
PVC non-sheathed cable with single-wire conductor	H05V-U	300/500	1	0.5 ... 1	Wiring in switchgear, distributors and lighting
PVC non-sheathed cable with fine-wire conductor	H05V-K	300/500	1	0.5 ... 1	Wiring in switchgear, distributors and lighting
PVC single-core non-sheathed cable with single-wire conductor	H07V-U	450/750	1	1.5 ... 16	Wiring in switchgear and distributors
PVC single-core non-sheathed cable with multi-wire conductor	H07V-R	450/750	1	6 ... 500	Wiring in switchgear and distributors
PVC single-core non-sheathed cable with fine-wire conductor	H07V-K	450/750	1	1.5 ... 240	Wiring in switchgear and distributors

# Cables

## Rubber-insulated cables

Designation to DIN EN 50525-1 VDE 0285-525-1	Type codes	Rated voltage Vo/V	No. of wires	Nominal cross-section	Suitable for
Heat-resistant silicone rubber-insulated cable	H05SJ-K	300/500	1	0.5 ... 16	Lighting and operating equipment, and in switchgear and distributors
Braided flexible cords	H03RT-F	300/300	2+	0.75 ... 1.5	Dry rooms with low mechanical stresses
Light rubber-sheathed cable	H05RR-F	300/500	2 ... 5	0.75 ... 2.5	For domestic appliances with medium mechanical stresses
Heavy rubber-sheathed cable	H07RN-F	450/750	1 2 + 5 3 + 4	1.5 ... 400 1 ... 25 1 ... 95	Dry and damp rooms and outdoors for heavy appliances with high mechanical stresses and in industrial water

## Colour coding of conductors

Green & yellow	Blue	Black	Brown
PE conductors (PE) and PEN conductors (with additional blue marking on the wire ends). Green and yellow must not be used for any other conductor.	Neutral conductor (AC), Middle conductor (DC)	Recommended for systems with single-wire cables	Recommended for systems where one group of cables is to be distinguished from another

# Cables

## Allocation to various conductor codes

Conductor designation		Letters, numbers	Symbol	Colours
AC current network	Phase conductor 1	L 1		–
	Phase conductor 2	L 2		–
	Phase conductor 3	L 3		–
	Neutral conductor	N		Blue
DC current network	Positive	L+	+	–
	Negative	L–	–	–
	Neutral conductor	M		Blue
PE conductor		PE		Green & yellow
PEN conductor		PEN		Green and yellow (with additional blue marking on the wire ends)
Earth		E		–
Mass		MM	^	–

## Abbreviations for colours

Colour	Green & yellow	Blue	Black	Brown	Red	Grey	White
Abbreviation to IEC 60 757	GNYE	BU	BK	BN	RD	GY	WH

# Cable

## External diameters of lines and cables

Cable	Cross-section	Mean external diameter	
	mm <sup>2</sup>	Minimum mm	Maximum mm
H03VV-F32	2 x 0.5	4.8	6.0
	2 x 0.75	5.2	6.4
	3 x 0.5	5.0	6.2
	3 x 0.75	5.4	6.8
	4 x 0.5	5.6	6.8
	4 x 0.75	6.0	7.4
H05VV-F	2 x 4	10.0	12.0
	3 G 4	11.0	13.0
	3 x 4	11.0	13.0
	5 G 4	13.5	15.5
	5 x 4	13.5	15.5
H07RN-F	3 x 70	39.0	49.5
	3 x 95	44.0	54.0
	3 x 120	47.5	59.0
	3 x 150	52.5	66.5
	6 x 1.5	14.0	17.0
	6 x 2.5	16.0	19.5
	6 x 4	19.0	22.0
H05SJ-K	1 x 0.5	3.4	
	1 x 0.75	3.6	
	1 x 1.0	3.8	
	1 x 1.5	4.3	
	1 x 2.5	5.0	
	1 x 4.0	5.6	
	1 x 6.0	6.2	
	1 x 10.0	8.2	

# Cables

## Current carrying capacity of cables at an ambient temperature $\vartheta_U = 30\text{ }^\circ\text{C}$

Load capacity of flexible cables with $V_n \leq 1000\text{ V}$															
No. of current carrying conductors Installation type	$\vartheta_B$ in $^\circ\text{C}$ Insulating material	Design code Examples	Load in A at a nominal cross-section in $\text{mm}^2$												
			0.75	1	1.5	2.5	4	6	10	16	25	35	50	70	95
1 V1	70 Polyvinyl chloride	H05V-U H07V-U H07V-K NFYW	15	19	24	32	42	54	73	98	129	158	198	245	292
2 or 3 V2, V3	Natural rubber, synthetic rubber	H05RND5-F H07RND5-F NMHVöu NSHCöu	12	15	18	26	34	44	61	82	108	135	168	207	250
2 or 3 V2, V3	70 Polyvinyl chloride	H05VWH6-F H07VWH6-F NYMHYV NYSLYö	12	15	18	26	34	44	61	82	108	-	-	-	-

Load capacity of flexible cables with $V_n > 0.6\text{ kV}/1\text{ kV}$															
No. of loaded wires Rated voltage Installation type	$\vartheta_B$ in $^\circ\text{C}$ Insulating material	Design code Examples	Load in A at a nominal cross-section in $\text{mm}^2$												
			2.5	4	6	10	16	25	35	50	70	95	120	150	185
3 $\leq 6\text{ kV}/$ 10 kV V2	80 Ethylene propylene rubber	NSSHöu	30	41	53	74	99	131	162	202	250	301	352	404	461
3 $\geq 6\text{ kV}/$ 10 kV V2	80 Ethylene propylene rubber	NSSHöu	-	-	-	-	105	139	172	215	265	319	371	428	488

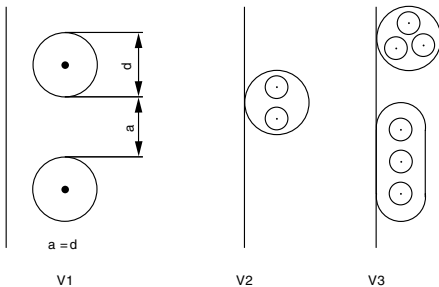

# Cables

## Conversion of conductor cross-sections and diameters into AWG (American Wire Gauge) numbers

### British and US dimensions for cables and lines

Within the US sphere of influence, the dimensions of copper conductors for heavy current and tele-communications applications are generally given in AWG numbers.

These correspond as follows:

AWG No.	Diameter	Cross-section	Conductor resistance
	mm	mm <sup>2</sup>	W/km
MCM 500	17.96	254	0.07
MCM 350	15.03	178	0.1
MCM 250	12.7	127	0.14
4/0	11.68	107.2	0.18
3/0	10.4	85	0.23
2/0	9.27	67.5	0.29
1/0	8.25	53.5	0.37
1	7.35	42.4	0.47
2	6.54	33.6	0.57
4	5.19	21.2	0.91
6	4.12	13.3	1.44
8	3.26	8.37	2.36
10	2.59	5.26	3.64
12	2.05	3.31	5.41
14	1.63	2.08	8.79
16	1.29	1.31	14.7
18	1.024	0.823	23

# Rittal – The System.

Faster – better – everywhere.



## Bars

### Resistance of copper busbars in order to calculate their heat loss when used for DC current ( $r_{GS}$ ) or AC current ( $r_{WS}$ )

	Strand dimensions <sup>2)</sup>	Resistance of busbar systems in mΩ/m <sup>1)</sup>							
		I 1 main conductor		III 3 main conductors		II III 3 x 2 main conductors		III III III 3 x 3 main conductors	
		$r_{GS}$	$r_{WS}$	$r_{GS}$	$r_{WS}$	$r_{GS}$	$r_{WS}$	$r_{GS}$	$r_{WS}$
		1	2	3	4	5	6	7	8
1	12 x 2	0.871	0.871	2.613	2.613				
2	15 x 2	0.697	0.697	2.091	2.091				
3	15 x 3	0.464	0.464	1.392	1.392				
4	20 x 2	0.523	0.523	1.569	1.569				
5	20 x 3	0.348	0.348	1.044	1.044				
6	20 x 5	0.209	0.209	0.627	0.627				
7	20 x 10	0.105	0.106	0.315	0.318	0.158	0.160		
8	25 x 3	0.279	0.279	0.837	0.837	0.419	0.419		
9	25 x 5	0.167	0.167	0.501	0.501	0.251	0.254		
10	30 x 3	0.232	0.232	0.696	0.698	0.348	0.349		
11	30 x 5	0.139	0.140	0.417	0.421	0.209	0.211		
12	30 x 10	0.070	0.071	0.210	0.214	0.105	0.109		
13	40 x 3	0.174	0.174	0.522	0.522	0.261	0.266		
14	40 x 5	0.105	0.106	0.315	0.318	0.158	0.163		
15	40 x 10	0.052	0.054	0.156	0.162	0.078	0.084	0.052	0.061
16	50 x 5	0.084	0.086	0.252	0.257	0.126	0.132	0.084	0.092
17	50 x 10	0.042	0.043	0.126	0.129	0.063	0.065	0.041	0.043
18	60 x 5	0.070	0.071	0.210	0.214	0.105	0.112	0.070	0.079
19	60 x 10	0.035	0.037	0.105	0.112	0.053	0.062	0.035	0.047
20	80 x 5	0.052	0.054	0.156	0.162	0.078	0.087	0.052	0.062
21	80 x 10	0.026	0.029	0.078	0.087	0.039	0.049	0.026	0.039
22	100 x 5	0.042	0.045	0.126	0.134	0.063	0.072	0.042	0.053
23	100 x 10	0.021	0.024	0.063	0.072	0.032	0.042	0.021	0.033
24	120 x 10	0.017	0.020	0.051	0.060	0.026	0.036	0.017	0.028

Key to symbols:

$r_{GS}$  = Total resistance of busbar system when used for DC current in mΩ/m

$r_{WS}$  = Total resistance of busbar system when used for AC current in mΩ/m

Footnotes:

<sup>1)</sup> The resistance figures are based on an assumed average conductor temperature of 65 °C (ambient temperature + self-heating) and a specific resistance of

$$\rho = 20.9 \left[ \frac{\text{m}\Omega \cdot \text{mm}^2}{\text{m}} \right]$$

<sup>2)</sup> Dimensions match those of standard DIN 43 671



# Bars

## Continuous currents for busbars

Made from copper to DIN 43 671:1975-12 with square cross-section in indoor locations at 35 °C air temperature and 65 °C bar temperature, vertical position or horizontal position of the bar width.

Width x thickness mm	Cross-section mm <sup>2</sup>	Weight <sup>1)</sup>	Material <sup>2)</sup>	Continuous current in A			
				AC current up to 60 Hz		DC current + AC current 16 <sup>2</sup> / <sub>3</sub> Hz	
				Uncoated bar	Coated bar	Uncoated bar	Coated bar
12 x 2	23.5	0.209	E-Cu F 30	108	123	108	123
15 x 2	29.5	0.262		128	148	128	148
15 x 3	44.5	0.396		162	187	162	187
20 x 2	39.5	0.351		162	189	162	189
20 x 3	59.5	0.529		204	237	204	237
20 x 5	99.1	0.882		274	319	274	320
20 x 10	199	1.77		427	497	428	499
25 x 3	74.5	0.663		245	287	245	287
25 x 5	124	1.11		327	384	327	384
30 x 3	89.5	0.796		285	337	286	337
30 x 5	149	1.33		379	447	380	448
30 x 10	299	2.66		573	676	579	683
40 x 3	119	1.06		366	435	367	436
40 x 5	199	1.77		482	573	484	576
40 x 10	399	3.55		715	850	728	865
50 x 5	249	2.22		583	697	588	703
50 x 10	499	4.44		852	1020	875	1050
60 x 5	299	2.66		688	826	996	836
60 x 10	599	5.33		985	1180	1020	1230
100 x 10	999	8.89		1490	1810	1600	1940
120 x 10	1200	10.7	1740	2110	1890	2300	

<sup>1)</sup> Calculated with a density of 8.9 kg/dm<sup>3</sup>

<sup>2)</sup> Reference basis for continuous current values (values taken from DIN 43 671)

## Calculation of heat loss in busbars

The heat loss of busbars and individual circuits must be calculated by the system manufacturers themselves, using the following formula:

$$P_{NK} = \frac{I_{NK}^2 \cdot r \cdot l}{1000} \text{ [W]}$$

Where:

$P_{NK}$  Heat loss in W

$I_{NK}$  Rated current of affected circuit/busbars in A

$l$  Length of conductor through which  $I_{NK}$  flows in m;

$r$  Resistance of cable system or, in the case of busbars, resistance of busbar system in  $m\Omega/m$

### Note:

The rated current specified for a busbar arrangement is the maximum permissible current which this busbar is able to conduct on its entire length. Often, the heat loss calculated with this rated current does not represent a realistic value.

Depending on the spatial division of the power supply (or supplies) and outlets, busbars conduct graduated "operating currents". Therefore, it is expedient for heat loss to be calculated section by section directly with these actual currents.

In order to calculate the heat loss in accordance with the above formula, in individual cases it can be assumed that the rated current of a circuit and/or the "operating currents" of the busbar sections and the corresponding length of the conductor system in the installation or distributor are known. By contrast, the resistance of conductor systems – particularly the AC current resistance of busbar arrangements – cannot simply be taken from a document or determined yourself. For this reason, and in order to obtain comparable results when determining heat losses, the table shows the resistance values in  $\Omega/m$  for the most common cross-sections of copper busbars.

## Current correction for Cu busbar systems

In DIN 43 671 (measurement of continuous current for copper busbars), Table 1 shows continuous currents which generate a temperature of 65 °C in E-Cu busbars with a square cross-section in internal installations at an air temperature of 35 °C.

Higher bar temperatures are permissible and depend on the material having direct contact with the bars.

For other temperature conditions, Figure 2 of DIN 43 671 shows a correction factor which is multiplied by the original rated current to obtain the new permissible rated current.

Example:

Bar cross-section

30 x 10 mm

Permissible bar temperature 85 °C

Ambient temperature 35 °C

Correction factor (see fig.)

= 1.29

$$I_1 = I_N \cdot k_2 = 573 \text{ A} \cdot 1.29 = 740 \text{ A}$$

To this end, 8% = 60 A is added to the (assumed) more favourable emission level of the bars, producing the new permissible rated current:

$$I_N = I_1 + I_1 \cdot 8/100 = 740 \text{ A} + 60 \text{ A} = 800 \text{ A}$$

Generally speaking, busbar systems are purpose-designed for use in enclosures. In addition, because an enclosure protection category of IP 54 or IP 55 is usually required, a more favourable emission level of copper bars than 0.4 can be assumed compared with the table figures in DIN 43 671 for bare Cu bars, and consequently, a higher rated current load of around 6 – 10% of the levels specified in the DIN table is possible.

On this basis, the following current correction may be implemented:

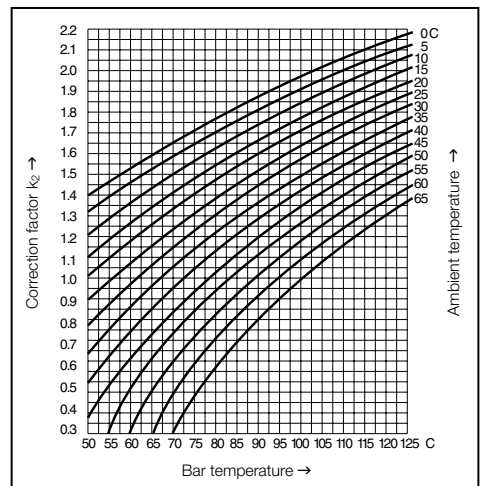

# Bars

## Hole patterns and holes to DIN 43 673

Bar widths mm	12 to 50		25 to 60			60			80 to 120				
Form <sup>1)</sup>	1		2			3			4				
Drilled holes in the bar ends (drilling pattern)													
	Nominal width b	d	e <sub>1</sub>	d	e <sub>1</sub>	e <sub>2</sub>	e <sub>1</sub>	e <sub>2</sub>	e <sub>3</sub>	e <sub>1</sub>	e <sub>2</sub>	e <sub>3</sub>	
Hole size	12	5.5	6										
	15	6.6	7.5										
	20	9.0	10										
	25	11	12.5	11	12.5	30							
	30	11	15	11	15	30							
	40	13.5	20	13.5	20	40							
	50	13.5	25	13.5	20	40							
	60				13.5	20	40	17	26	26			
	80										20	40	40
	100										20	40	50
	120										20	40	60

Permissible deviations for hole-centre distances  $\pm 0.3$  mm

<sup>1)</sup> Form designations 1 – 4 match DIN 46 206, part 2 – Flat-type screw terminal

## Screwed cable glands

Recommended tightening torques to DIN 43 673-1

Thread size	Nm
M6	4.5
M8	10
M10	20
M12	40
M16	80

Strength class of screws: at least 8.8

# Bars

## Examples of busbar screw connections

### Longitudinal connections

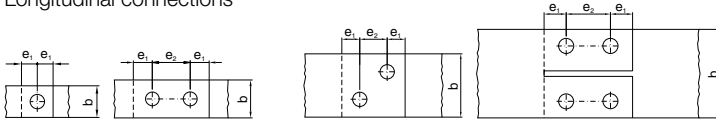

### Angular connections

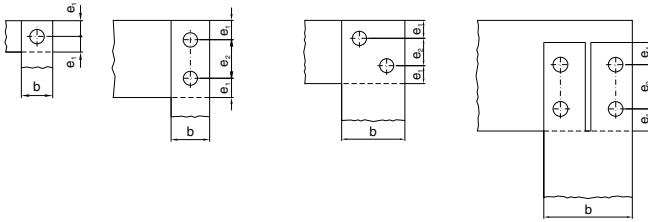

### T-connections

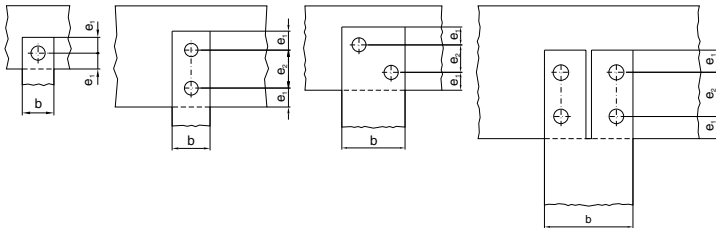

For figures for dimensions  $b$ ,  $d$ ,  $e_1$  and  $e_2$  refer to table "Hole patterns and holes to DIN 43 673", page 44. Slots are permissible at one end of the bar or at the end of a bar stack.

# Rittal – The System.

Faster – better – everywhere.

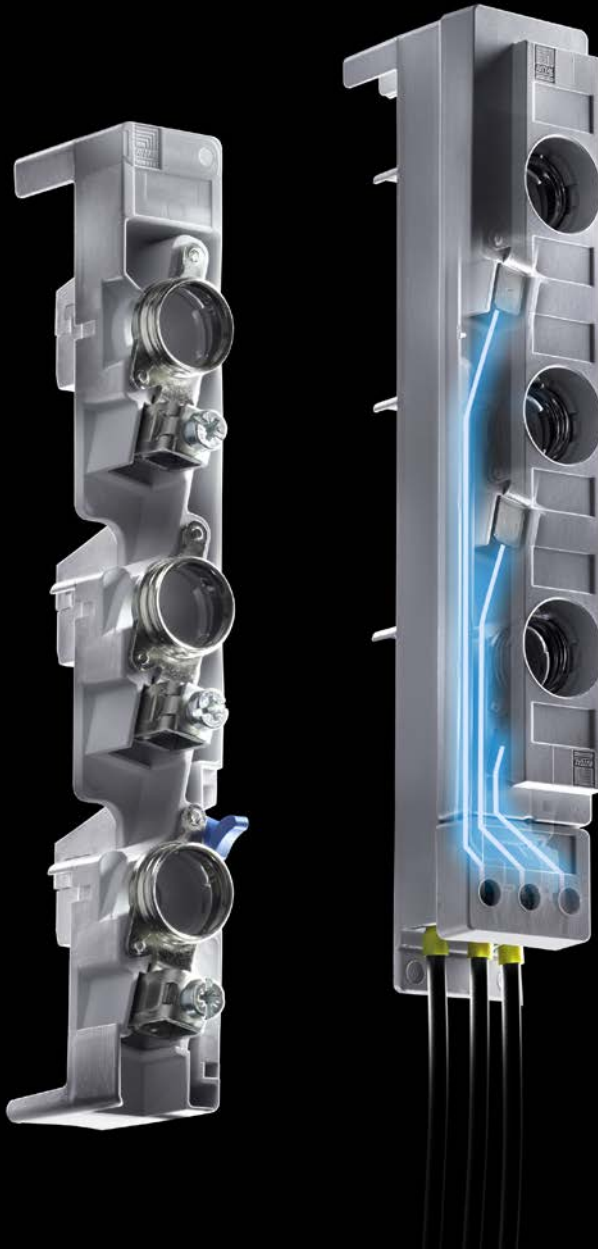

# Fuses

## Overcurrent protection devices (low-voltage fuses)

Rated current in A	Colour of indicator	Size of fuse insert System		Maximum rated heat loss in W System		Screw cap		
		Diazed	Neozed	Diazed	Neozed	System	Thread	Gauge piece
		D	D0	D	D0			
2	Pink	ND and D II	D01	3.3	2.5	ND	E 16	Gauge ring
4	Brown			2.3	1.8	D II	E 27	Adaptor screw
6	Green			2.3	1.8	D III	E 33	Adaptor screw
10	Red			2.6	2.0	DIV H	R1¼"	Adaptor sleeve
16	Grey			3.2	2.5	D01	E 14	
20	Blue	D II	D02	3.5	3.0	D02	E18	Socket fitting insert
25	Yellow			4.0	3.5	D03	M30 x 2	
35	Black	DIII		5.2	4.0	The dimensions of the fuse inserts depend on the rated current.		
50	White			6.5	5.0			
63	Copper			7.0	5.5			
80	Silver	D IV H	D03	8.5	6.5			
100	Red		9.0	7.0				

D system (Diazed)  
500 V to 100 A, AC 690 V,  
DC 600 V to 63 A

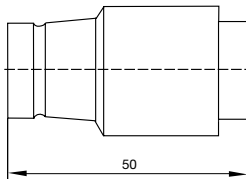

D0 system (Neozed)  
AC 400 V,  
DC 250 V to 100 A

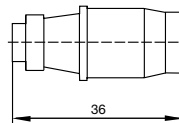

# Fuses

## D system, D0 system (D-type fuse-links)

The D system and the D0 system are distinguished by the fact that the fuse insert is non-interchangeable in terms of its rated current and contact hazard protection. It is suitable for both industrial applications and domestic installations, and can be used by laypersons. D fuses consist of a fuse base, a fuse insert, a screw cap and a gauge piece.

The following must be observed with the D0 system: D0 fuses consist of a fuse base, a fuse insert, a screw cap and a gauge piece. The D0 system differs from the D system in that it has a different rated voltage and different dimensions.

- Approval: Still only approved in Germany, Austria, Denmark and Norway.
- Rated voltage: 400 V, compared with DII 500 V (660 V), DIII for 660 V.

## NH system

The NH system (low-voltage high-breaking-capacity fuse system) is a standardised fuse system consisting of a fuse base, the replaceable fuse insert and the control component for replacing the fuse insert. NH fuses may also have fuse monitors and tripping mechanisms.

It is not non-interchangeable with regard to the rated current and contact hazard protection; consequently, the NH system is not suitable for use by laypeople.



RiLine busbar systems 3-/4-pole



# Fuses

## Maximum permissible total break time of short-circuit protection devices for copper conductors and rated currents of standardised fuses

Nominal cross-section of cable	Smallest short-circuit current $I_m$	Maximum permissible total break time $t$	Rated currents of fuses in accordance with DIN EN 60269-1		
			gII	gI	aM
mm <sup>2</sup>	A	s	A	A	A
0.196 <sup>1)</sup>	50	0.20	6	4	2
0.283 <sup>2)</sup>	70	0.21		6	4
0.5	120	0.23	12	10	8
0.75	180	0.23	16	12	12
1	240	0.23	25	20	16
1.5	310	0.30	32	25	20
2.5	420	0.46	40	40	32
4	560	0.66	50	50	40
6	720	0.90	80	80	63
10	1000	1.3	100	100	100
16	1350	1.8	–	160	125
25	1800	2.5	–	200	200
33	2200	3.3	–	250	250
50 <sup>3)</sup>	2700	4.5	–	315	315
70	3400	5	–	400	400
95	4100	5	–	500	400
120	4800	5	–	500	500
150	5500	5	–	630	630
285	6300	5	–	630	630
240	7400	5	–	800	800

<sup>1)</sup> Nominal diameter 0.5 mm

<sup>2)</sup> Nominal diameter 0.6 mm

<sup>3)</sup> Actual cross-section 47 mm<sup>2</sup>

# Fuses

## Categories of low-voltage fuses

### Functional categories

These specify the current range within which the fuse protection is able to disconnect.

Functional categories	
g	Full range breaking capacity fuse-links provide over-load protection and short-circuit protection. They are able to continuously conduct currents up to their rated current, and reliably disconnect currents from the smallest fusing current to the rated breaking current.
a	Partial range breaking capacity fuse-links only protect against short-circuits. They are able to continuously conduct currents up to their rated current, but can only disconnect currents above a multiple of their rated current up to the rated breaking current.

### Specified protected objects

Types of protected objects	
L	Cable and line protection
R	Semi-conductor protection
M	Switchgear protection
B	Mining and plant protection
Tr	Transformer protection
G	Equipment

The low-voltage fuses are indicated by two letters, e.g. gL.

### Operating categories

This produces the following operating categories: Operating categories are indicated by two letters, the first showing the functional category, the second the object to be protected.

Operating categories	
gL	Full-range cable and line protection
gR	Full-range semi-conductor protection
gB	Full-range mining installation protection
gTr	Full-range transformer protection
aM	Partial-range switchgear protection
aR	Partial-range semi-conductor protection

# Fuses

## Heat loss

### NH and D system

Size	Heat loss			
	max. fuse insert gL at rated current		max. fuse insert aM at rated current	
	500 V	690 V	500 V	690 V
NH 00	7.5 W	10 W	7.5 W	9 W
NH 0	16 W	–	–	–
NH 1	23 W	23 W	23 W	28 W
NH 2	34 W	34 W	34 W	41 W
NH 3	48 W	48 W	48 W	58 W
NH 4a	110 W	70 W	110 W	110 W

# Fuses

## Rated voltage/rated current

### NH and D system

Size	Rated voltage $\approx$ 440 V		
	~ 500 V		~ 690 V <sup>4)</sup>
NH 00, NH 00/000	6 A – 160 A		6 A – 100 A
NH 0 <sup>1)</sup>	6 A – 160 A		–
NH 1	80 A – 250 A		80 A – 250 A <sup>2)</sup>
NH 2	125 A – 400 A		125 A – 315 A
NH 3	315 A – 630 A		315 A – 500 A
NH 4a	500 A – 1250 A		500 A – 800 A
D 01 (E 14)	max. 16 A	–	–
D 02 (E 18)	max. 63 A	–	– <sup>3)</sup>
D II (E 27)	max. 25 A	max. 25 A	–
D III (E 33)	max. 63 A	max. 63 A	max. 63 A

<sup>1)</sup> NH... fuse insert

<sup>2)</sup> D...fuse insert

<sup>3)</sup> Only as a spare

<sup>4)</sup> For use in accordance with VDE 0636-3 only up to ~ 500 V

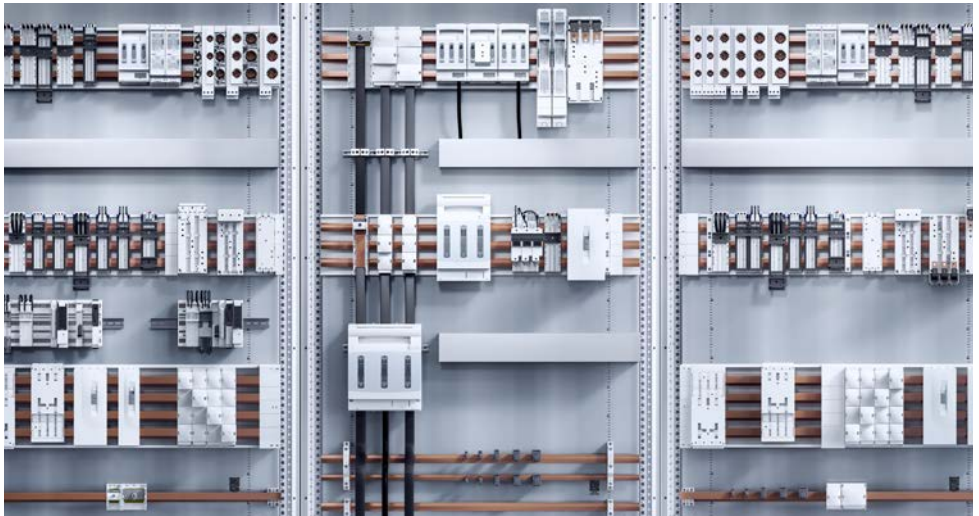

Power distribution with 3 main focal points:

- Busbar systems
- Ri4Power Form 1-4
- Ri4Power ISV distribution enclosures

# Motors

## Rated motor currents of three-phase motors

**(Guideline values for squirrel-cage rotors)**

**The smallest possible short-circuit fuse for three-phase motors**

The maximum value is based on the switchgear or motor protective relay. The rated motor currents apply to standard, internally and surface-cooled three-phase motors with 1500 rpm.

Direct start: Start-up current max. 6 x rated motor current; start-up time max. 5 s.

Y/Δ start: Start-up current max. 2 x rated motor current; start-up time 15 s.

Rated fuse currents with Y/Δ start also apply to three-phase motors with slip ring rotors. For a higher rated/start-up current and /or longer start-up time, a larger fuse should be used. Table applies to "slow-blow" or "gL" fuses (VDE 0636).

**In the case of NH fuses with aM characteristics, a fuse is selected which matches the rated current.**

Motor output		η	220 V/230 V			380 V/400 V			500 V			660 V/690 V		
			Rated motor current	Fuse		Rated motor current	Fuse		Rated motor current	Fuse		Rated motor current	Fuse	
				Direct start	Y/Δ		Direct start	Y/Δ		Direct start	Y/Δ		Direct start	Y/Δ
kW	cos φ	%	A	A	A	A	A	A	A	A	A	A	A	A
0.25	0.7	62	1.4	4	2	0.8	2	2	0.6	2	-	0.5	2	-
0.37	0.72	64	2.1	6	4	1.2	4	2	0.9	2	2	0.7	2	-
0.55	0.75	69	2.7	10	4	1.6	4	2	1.2	4	2	0.9	4	2
0.75	0.8	74	3.4	10	4	2	6	4	1.5	4	2	1.1	4	2
1.1	0.83	77	4.5	10	6	2.6	6	4	2	6	4	1.5	4	2
1.5	0.83	78	6	16	10	3.5	6	4	2.6	6	4	2	6	4
2.2	0.83	81	8.7	20	10	5	10	6	3.7	10	4	2.9	10	4
3	0.84	81	11.5	25	16	6.6	16	10	5	16	6	3.5	10	4
4	0.84	82	15	32	16	8.5	20	10	6.4	16	10	4.9	16	6
5.5	0.85	83	20	32	25	11.5	25	16	9	20	16	6.7	16	10
7.5	0.86	85	27	50	32	15.5	32	16	11.5	25	16	9	20	10
11	0.86	87	39	80	40	22.5	40	25	17	32	20	13	25	16
15	0.86	87	52	100	63	30	63	32	22.5	50	25	17.5	32	20
18.5	0.86	88	64	125	80	36	63	40	28	50	32	21	32	25
22	0.87	89	75	125	80	43	80	50	32	63	32	25	50	25
30	0.87	90	100	200	100	58	100	63	43	80	50	33	63	32
37	0.87	90	124	200	125	72	125	80	54	100	63	42	80	50
45	0.88	91	147	250	160	85	160	100	64	125	80	49	80	63
55	0.88	91	180	250	200	104	200	125	78	160	80	60	100	63
75	0.88	91	246	315	250	142	200	160	106	200	125	82	160	100
90	0.88	92	292	400	315	169	250	200	127	200	160	98	160	100
110	0.88	92	357	500	400	204	315	200	154	250	160	118	200	125
132	0.88	92	423	630	500	243	400	250	182	250	200	140	250	160
160	0.88	93	500	630	630	292	400	315	220	315	250	170	250	200
200	0.88	93	620	800	630	368	500	400	283	400	315	214	315	250
250	0.88	93	-	-	-	465	630	500	355	500	400	268	400	315

## Basic principles

### Enclosure climate control

Device type	Application area
Enclosure heaters	To heat or stabilise the enclosure internal temperature compared with the ambient temperature in order to avoid condensation, or achieve minimum temperatures for switchgear and controlgear. For use as an anti-freeze protection e.g. for pneumatic control devices.
Enclosure fan-and-filter unit	To dissipate heat from enclosures, and to distribute heat evenly. To avoid condensation. Used in situations where no aggressive media and no excessive incidence of dust is present in the ambient air.
Air/air heat exchanger	To dissipate heat from enclosures. Thanks to two separate air circuits, no ambient air is able to enter the enclosure. Consequently, it may be used in an environment contaminated with dust and aggressive media.
Air/water heat exchanger	To dissipate heat and to cool enclosures to below the ambient temperature. For use in extreme environments (temperature/dirt).
Enclosure cooling unit	To dissipate heat and to cool enclosures to below the ambient temperature. The ambient air is separated from the enclosure internal air.
Direct Cooling Package (DCP)	To effectively dissipate heat directly from the component. A water-cooled mounting plate dissipates the heat loss directly from the component, and is completely silent.
Recooling systems	To supply air/water heat exchangers, DCPs and machines/processes with cold water. These systems are distinguished by a high level of temperature precision and excellent performance.

# Fundamental principles

## Constant climates to IEC 60 068

Code	Temperature		Relative humidity %		Air pressure	Comment
	°C	Standard deviation	Rating	Standard deviation	mbar	
23/83	23	± 2 °C	83	± 3	800 to 1060	damp warm and humid warm and dry
40/92	40	± 2 °C	92	± 3		
55/20	55	± 2 °C	≤ 20	–		

## Damp alternating climate to IEC 60 068

Exposure to a damp alternating climate as defined in this standard consists of the alternating effects of climate 23/83 and climate 40/92 to IEC 60 068.

In the alternating climate chamber, changeovers are implemented as follows:

- after 14 hours 40/92 = warm and humid,
- switch to 10 hours 23/83 = damp
- on a 24-hour cycle.

## Blue e+: Sustainable technology for all applications



A cooling unit that's at home in any environment. Blue e+ units are ideal for all industries and environments. Choose from a range of efficient solutions covering all requirements and applications.

# Rittal – The System.

Faster – better – everywhere.

## Climate control from the smallest to the largest

---

- Cooling with ambient air
- Cooling units
- Liquid cooling
- Heaters



Sustainability with Blue e + cooling units: Average energy savings of 75%. This means a saving of 2100 kWh per year.





- World-class in all sizes and output classes
- Sustainable machine and enclosure climate control with Blue e+
- The most efficient technology with which to harness untapped potential in the production environment



# Basic principles

## Temperature rise in enclosures

### Problems with temperature rise in the enclosure

- Incorrect dimensioning of switchgear and conductors
- Contact problems with live conductors
- Eddy currents

When operating a low-voltage switchgear assembly, short-circuit losses occur, leading to a temperature rise in the enclosure internal air and, connected with this, inferior heat dissipation via the surface of the installed components and assemblies, which can even lead to damage.

Overtemperatures occurring in isolated locations where there is no natural air movement to dissipate heat, known as hot spots, are particularly critical. The cause of the overtemperature may lie in the fact that the operating equipment is too densely

packed, the components and conductors are incorrectly dimensioned, or there is poor contact between individual live conductors.

Another potential cause, particularly in power distributors with high currents, may lie in the formation of eddy currents in the assembly components and metallic surfaces adjacent to the conductors:

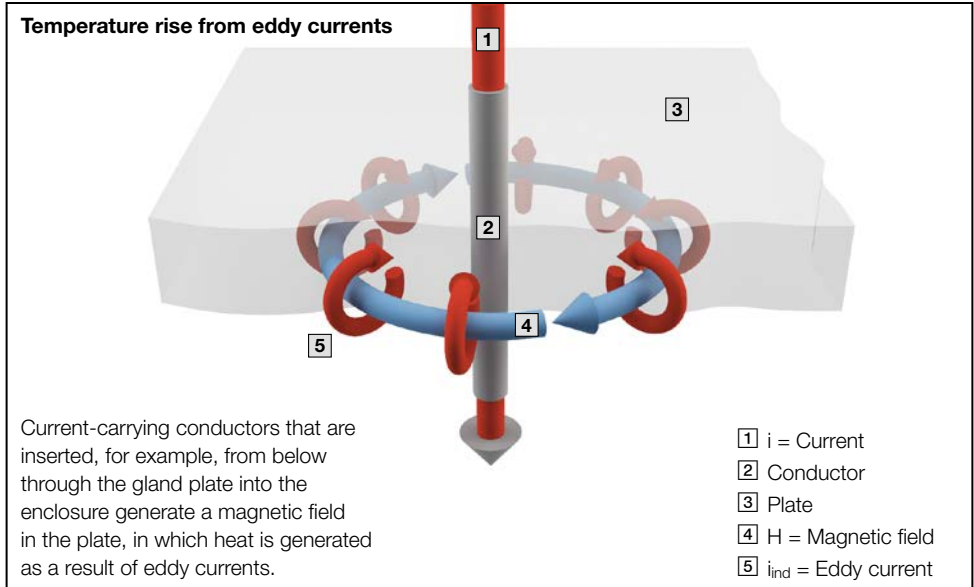

# Basic principles

## Calculation basis for enclosure climate control

$\dot{Q}_v$  = Heat loss installed in the enclosure [W]

$\dot{Q}_s$  = Heat loss dissipated via the enclosure surface [W]

$\dot{Q}_s > 0$ : Radiation ( $T_i > T_u$ )

$\dot{Q}_s < 0$ : Irradiation ( $T_i < T_u$ )

$\dot{Q}_K$  = Required cooling output of an enclosure cooling unit [W]

$\dot{Q}_H$  = Required thermal output of an enclosure heater [W]

$q_W$  = Specific thermal output of a heat exchanger [W/K]

$\dot{V}$  Required volumetric air flow of a fan-and-filter unit to maintain the maximum permissible temperature difference between the extracted air and the emitted air [m<sup>3</sup>/h]

$T_i$  = Required interior temperature of enclosure [°C]

$T_u$  = Ambient temperature of enclosure [°C]

$\Delta T = t - T_u$ : Max. admissible temperature difference [K]

$A$  = Effective enclosure surface area which radiates heat in accordance with VDE 0660, Part 507 [m<sup>2</sup>]

$k$  = Heat transfer coefficient [W/m<sup>2</sup> K] with static air for sheet steel –  $k = 5.5$  W/m<sup>2</sup> K

### Heat radiated by the enclosure surface

$\dot{Q}_s = k \cdot A \cdot (T_i - T_u)$

$\dot{Q}_s < 0$ : Absorption ( $T_i < T_u$ )

$\dot{Q}_s > 0$ : Dissipation ( $T_i > T_u$ )

In addition, the following applies:

$\dot{Q}_s = \dot{Q}_v - \dot{Q}_K$  und  $\dot{Q}_s = \dot{Q}_v + \dot{Q}_H$

If  $\dot{Q}_K = \dot{Q}_H = 0$  then:

$\dot{Q}_s = \dot{Q}_v = k \cdot A \cdot (T_i - T_u)$

### Enclosure cooling unit

– Required cooling output:

$\dot{Q}_K = \dot{Q}_v - \dot{Q}_s$

$\dot{Q}_K = \dot{Q}_v - k \cdot A \cdot (T_i - T_u)$

### Enclosure heater

– Required thermal output:

$\dot{Q}_H = -\dot{Q}_v + \dot{Q}_s$

$\dot{Q}_H = -\dot{Q}_v + k \cdot A \cdot (T_i - T_u)$

### Air/air heat exchangers

– Required specific cooling output:

$q_W = \frac{\dot{Q}_v}{\Delta T} - k \cdot A$

$q_W = \frac{\dot{Q}_v}{(T_i - T_u)} - k \cdot A$

### Fan-and-filter units

– Required air volume flow:

$\dot{V} = f(h) \cdot \frac{\dot{Q}_v - \dot{Q}_s}{\Delta T}$  [m<sup>3</sup>/h]

where

$h$  = Operating altitude above sea level ( $h = 0$ ) [m]

$f(0 - 100) = 3.1 \text{ m}^3 \cdot \text{K/W} \cdot \text{h}$

$f(100 - 250) = 3.2 \text{ m}^3 \cdot \text{K/W} \cdot \text{h}$

$f(250 - 500) = 3.3 \text{ m}^3 \cdot \text{K/W} \cdot \text{h}$

$f(500 - 750) = 3.4 \text{ m}^3 \cdot \text{K/W} \cdot \text{h}$

$f(750 - 1000) = 3.5 \text{ m}^3 \cdot \text{K/W} \cdot \text{h}$

Example: Operating altitude = 300 m

$\dot{V} = 3.3 \cdot \frac{\dot{Q}_v - k \cdot A \cdot (T_i - T_u)}{T_i - T_u}$  [m<sup>3</sup>/h]







Rough calculation

$\dot{V} = 3.1 \frac{\dot{Q}_v}{\Delta T}$  [m<sup>3</sup>/h]

## Basic principles

### Calculation of effective enclosure surface area

A is calculated in accordance with IEC TR 60890 with due regard for the type of installation.

Enclosure installation type and formula calculation according to IEC TR 60890		
	Single enclosure, free-standing on all sides	$A = 1.8 \cdot H \cdot (W + D) + 1.4 \cdot W \cdot D$
	Single enclosure for wall mounting	$A = 1.4 \cdot W \cdot (H + D) + 1.8 \cdot D \cdot H$
	First or last enclosure in a suite, free-standing	$A = 1.4 \cdot D \cdot (H + W) + 1.8 \cdot W \cdot H$
	First or last enclosure in a suite for wall mounting	$A = 1.4 \cdot H \cdot (W + D) + 1.4 \cdot W \cdot D$
	Enclosure within a suite, free-standing	$A = 1.8 \cdot W \cdot H + 1.4 \cdot W \cdot D + D \cdot H$
	Enclosure within a suite for wall mounting	$A = 1.4 \cdot W \cdot (H + D) + D \cdot H$
	Enclosure within a suite for wall mounting, with covered roof areas	$A = 1.4 \cdot W \cdot H + 0.7 \cdot W \cdot D + D \cdot H$

A = Area [m<sup>2</sup>]

W = Enclosure width [m]

H = Enclosure height [m]

D = Enclosure depth [m]

Conversions:

°C → °F:  $T_F = T_C \cdot 1.8 + 32$

°F → °C:  $T_C = (T_F - 32) : 1.8$

W → BTU:  $1 \text{ BTU} = 2.930 \cdot 10^{-4} \text{ kWh}$

(BTU = British Thermal Unit)







T<sub>F</sub> = Temperature in Fahrenheit

T<sub>C</sub> = Temperature in Celsius

# Basic principles

## Examples:

### Effective enclosure surface area for defined dimensions [m<sup>2</sup>]

Width mm	Height mm	Depth mm							
300	400	210	0.46	0.41	0.42	0.29	0.39	0.34	0.30
380	600	210	0.75	0.66	0.70	0.50	0.65	0.56	0.50
500	500	210	0.79	0.69	0.74	0.50	0.70	0.60	0.53
500	700	250	1.12	0.98	1.05	0.74	0.98	0.84	0.75
600	380	350	0.94	0.85	0.89	0.51	0.84	0.75	0.60
600	600	350	1.32	1.18	1.24	0.80	1.15	1.01	0.86
600	760	210	1.28	1.10	1.22	0.86	1.16	0.97	0.89
600	760	350	1.59	1.41	1.49	1.01	1.38	1.20	1.05
760	760	300	1.77	1.54	1.68	1.13	1.59	1.36	1.20
1000	1000	300	2.76	2.36	2.64	1.82	2.52	2.12	1.91
600	1200	600	3.10	2.81	2.81	2.02	2.52	2.23	1.98
600	1400	600	3.53	3.19	3.19	2.35	2.86	2.52	2.27
600	1600	600	3.96	3.58	3.58	2.69	3.19	2.81	2.56
800	1600	600	4.70	4.19	4.32	3.14	3.94	3.42	3.09
600	1800	600	4.39	3.96	3.96	3.03	3.53	3.10	2.84
800	1800	600	5.21	4.63	4.78	3.53	4.34	3.77	3.43
800	1800	800	6.08	5.50	5.50	4.03	4.93	4.35	3.90
600	2000	600	4.82	4.34	4.34	3.36	3.86	3.38	3.13
800	2000	600	5.71	5.07	5.23	3.92	4.75	4.11	3.78
800	2000	800	6.66	6.02	6.02	4.48	5.38	4.74	4.29
600	2200	600	5.26	4.73	4.73	3.70	4.20	3.67	3.42
800	2200	800	7.23	6.53	6.53	4.93	5.82	5.12	4.67

## Basic principles

### Enclosure protection categories against contact, foreign bodies and water

#### (IP code) DIN EN 60 529/IEC 60 529

Standard DIN EN 60 529 covers the protection of electrical operating equipment via enclosures, covers and the like and includes the following:

1. Protection of persons against contact with live or moving parts within the enclosure, and protection of the operating equipment against the ingress of solid bodies (contact and foreign body protection).
2. Protection of operating equipment against the ingress of water (water protection).
3. Codes for internationally agreed protection categories and degrees of protection.

Protection categories are indicated by a code consisting of the two code letters IP, which always remain constant, and two characteristic numerals for the degree of protection.

#### Example of protection category:

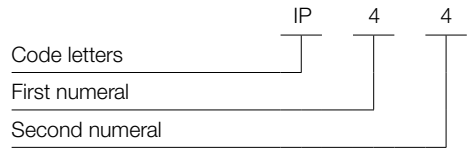

IP test in the Rittal test laboratory

# Basic principles

## Protection against contact and foreign bodies

First numeral	Degree of protection	
	Designation	Explanation
0	Non-protected	–
1	Protected against solid foreign objects with a diameter of 50 mm and greater	The object probe, a sphere 50 mm in diameter, must not penetrate fully. <sup>1)</sup> The articulated test finger may penetrate up to a length of 80 mm.
2	Protected against solid foreign objects with a diameter of 12.5 mm and greater	The object probe, a sphere 12.5 mm in diameter, must not penetrate fully. <sup>1)</sup>
3	Protected against solid foreign objects with a diameter of 2.5 mm and greater	The object probe, a sphere 2.5 mm in diameter, must not penetrate at all. <sup>1)</sup>
4	Protected against solid foreign objects with a diameter of 1.0 mm and greater	The object probe, a sphere 1.0 mm in diameter, must not penetrate at all. <sup>1)</sup>
5	Dust-protected	The ingress of dust is not fully prevented, but dust shall not enter to such an extent as to impair satisfactory operation of the device or safety.
6	Dust-tight	No ingress of dust at a partial vacuum of 20 mbar inside the enclosure.

<sup>1)</sup> Note: The full diameter of the object probe must not pass through an opening of the enclosure.

# Basic principles

## Water protection

Second numeral	Degree of protection	
	Designation	Explanation
0	Non-protected	No particular protection
1	Protected against vertically falling water drops	Vertically falling drops shall have no harmful effects.
2	Protected against vertically falling water drops when the enclosure is tilted up to 15°	Vertically falling drops shall not have any harmful effects when the enclosure is tilted up to 15° on either side of the vertical.
3	Protected against sprayed water	Water sprayed at an angle of up to 60° on either side of the vertical shall have no harmful effects.
4	Protected against splashed water	Water splashed on the enclosure from any direction shall have no harmful effects.
5	Protected against water jets	Water directed at the enclosure from any direction in a jet shall have no harmful effects.
6	Protected against powerful water jets	Water directed at the enclosure from every direction in a powerful jet shall have no harmful effects.
7	Protected against the effects of temporary immersion in water	Ingress of water in quantities causing harmful effects shall not be possible when the enclosure is temporarily immersed in water under standardised conditions of pressure and time.
8	Protected against the effects of continuous immersion in water	Ingress of water in quantities causing harmful effects shall not be possible when the enclosure is continuously immersed in water under conditions to be agreed between the manufacturer and the user. However, the conditions must not be more severe than for numeral 7.
9	Protected against the ingress of water in case of high-pressure/steam-jet cleaning	Water directed at the enclosure from every direction at high pressure and high temperature must not have any adverse effects.



# Basic principles

## Enclosure protection categories against external mechanical stresses

### (IK code) DIN EN 62 262/IEC 62 262

#### 1. This standard addresses

- a) the definitions for levels of protection from harmful impacts of mechanical loads within the enclosure on installed electrical components,
- b) codes for the various levels of protection,
- c) the requirements for each code,
- d) the tests to be carried out.

#### 2. 2. Structure of the IK code IK 08

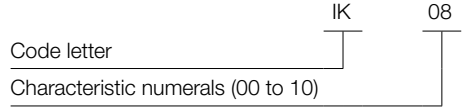

IK code	Stress energy (joules)	Height of fall (cm)	Test piece
01	0.15	–	Spring hammer
02	0.20	–	Spring hammer
03	0.35	–	Spring hammer
04	0.50	–	Spring hammer
05	0.70	–	Spring hammer
06	1.00	–	Spring hammer
07	2.00	40.0	Hammer, mass 0.5 kg
08	5.00	29.5	Hammer, mass 1.7 kg
09	10.00	20.0	Hammer, mass 5.0 kg
10	20.00	40.0	Hammer, mass 5.0 kg

#### 3. Application

The specified value (level of protection) must apply to the entire enclosure. In the event of varying levels of protection on the enclosure, these must be labelled separately (e.g. AE enclosure with acrylic glazed door).

#### 4. Assessment

After testing, the test piece must be fully functional. In particular, the protection category to IEC 60 529 must not be impaired (e.g. hinge bent, seal cut, gap in friction-locked connections or similar). Safety and reliability must not be impaired.

# Basic principles

## Short-circuit current terminology in three-phase systems

in accordance with DIN EN 60 909-0 VDE 0102

### Peak short-circuit current $i_p$

The maximum permissible instantaneous value of the anticipated short-circuit current.

Note: The size of the peak short-circuit current depends on the moment when the short-circuit occurs. Calculation of the peak short-circuit current  $i_p$  in a three-pole short-circuit refers to the conductor and the moment at which the maximum possible current occurs.

### Sustained short-circuit current $I_k$

The effective value of the short-circuit current which is retained once all transient reactions have decayed.

### Initial symmetrical short-circuit current $I_k''$

The effective value of the symmetrical AC component of an anticipated short-circuit current at the moment of occurrence of the short-circuit, if the short-circuit impedance retains the value at the time zero.

### Thermal short-circuit current $I_{th}$

Busbars, including their operating equipment, are likewise subject to thermal stress in the event of a short-circuit. The thermal stress depends on the level, time pattern and duration of the short-time current. The short-circuit current  $I_k$  is defined as the thermally effective mean whose effective value generates the same amount of heat as the short-circuit current which is variable in its DC and AC components during the short-circuit period  $t_k$ .

### Illustration:

Progression of the short-circuit current over time with remote short-circuit (diagrammatic representation).

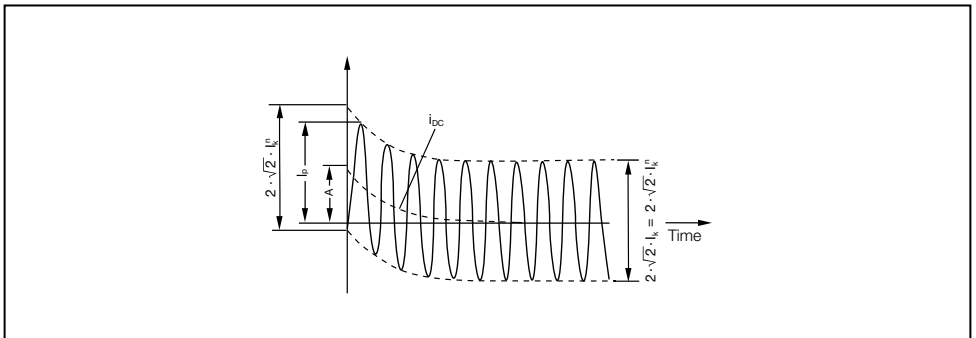

- $I_k''$  Initial symmetrical short-circuit current
- $i_p$  Peak short-circuit current
- $I_k$  Sustained short-circuit current
- $i_{DC}$  Decaying DC component of short-circuit current
- A Initial value of DC component  $i_{DC}$



# Transport

## Examples of crane transportation for Rittal enclosures

Max. suspension load in N for Rittal enclosures with the sling angle shown opposite

		VX SE	VX25	AX
90° 	For one eyebolt	3400	3400	2000
60° 	For four eyebolts	6400	6400	3200 with 2 eyebolts

### With eyebolts

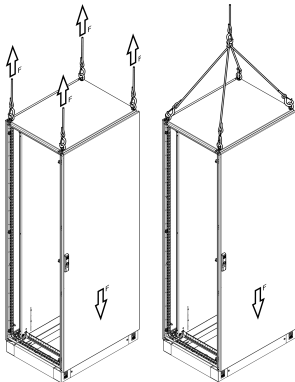

Individual enclosures are safely transported using the eyebolts. For symmetrical loads, the following maximum permissible loads apply:  
 $F \triangleq$  for 90° cable pull angle 13600 N  
 $F \triangleq$  for 60° cable pull angle 6400 N  
 $F \triangleq$  for 45° cable pull angle 4800 N

### With combination angle

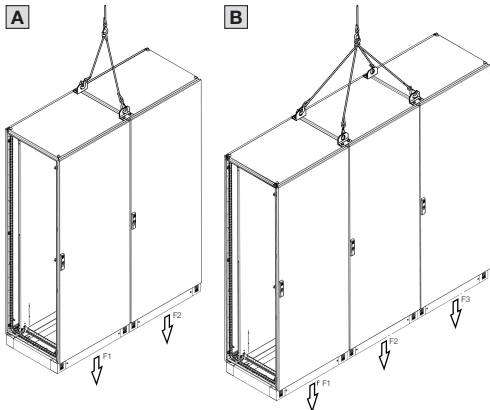

For the enclosure combination with internal baying brackets, 8617.500 (3 per vertical section) and combination angles shown here, the load capacity with a cable pull angle of 60° is as follows:

- A** F1 = 7000 N  
F2 = 7000 N
- B** F1 = 7000 N  
F2 = 14000 N  
F3 = 7000 N

# Transport

Normal crane suspension  
with additional pipe stabilisation

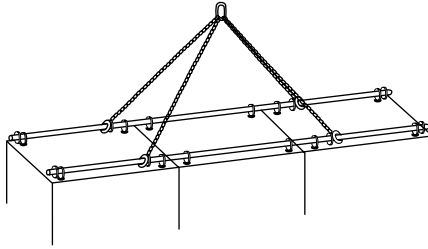

Adjustable girders

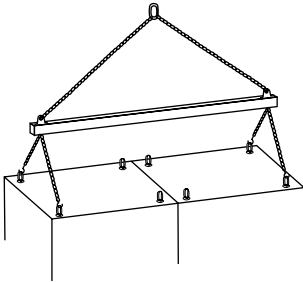

Adjustable girders

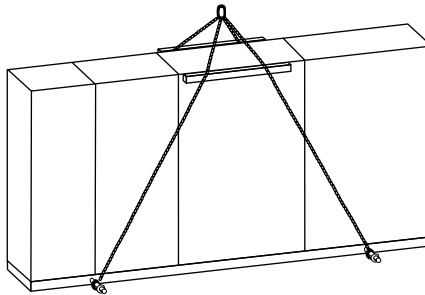
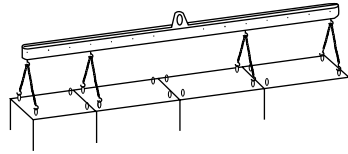

# Transport



Robust Rittal baying connections are crucial for safe transportation.

# Rittal – The System.

Faster – better – everywhere.

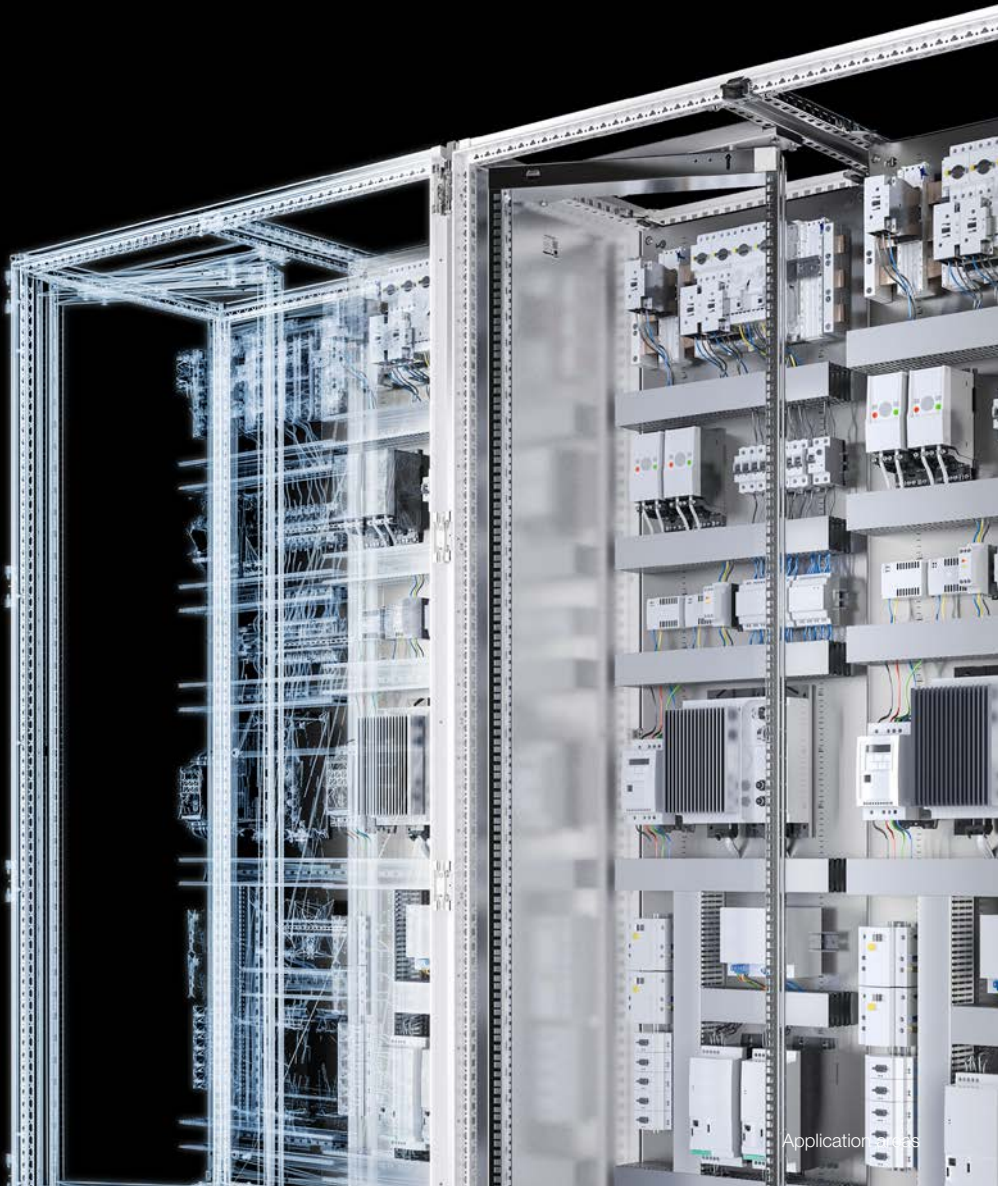

# Application areas

---

	Page
Machines	
Excerpt from DIN EN 60204-1(VDE 0113-1) .....	72
Switchgear	
One standard for all switchgear and controlgear .....	78
Brief overview of the use of DIN 61 439 .....	80
Individual verifications and verification methods .....	81
Special topics	
Quick guide to EMC/RF-shielded enclosures and the CE symbol .....	84
Fundamental principles and basic facts on explosion protection .....	90
Worldwide	
Background information on UL 508 and 508A .....	95
Approvals and permits .....	97
Earthquake protection .....	98

# Machines

## Excerpt from DIN EN 60204-1(VDE 0113-1)

(For precise wording, refer to current version!)

### Machine safety;

### Electrical equipment of machines, general requirements

#### 5.2 Connection of external PE conductors

One terminal for connecting the external PE conductor must be provided in the vicinity of the corresponding external conductor contact. The terminal must be dimensioned such that it facilitates the connection of an external copper conductor with a cross-section in accordance with the following table.

If a PE conductor from a material other than copper is used, the terminal size must be selected accordingly.

Cross-section $S$ of external conductors for mains connection (mm <sup>2</sup> )	Minimum cross-section of external PE conductor (mm <sup>2</sup> )
$S \leq 16$	$S$
$16 < S < 35$	16
$35 < S \leq 400$	$S/2$

The terminal for the external PE conductor must be labelled with the letters "PE". Use of the designation "PE" should be confined to the terminal for connecting the PE conductor system of the machine to the external PE conductor of the mains connection.

In order to avoid misunderstandings, other terminals used for the connection of machine parts to the PE conductor system must not be designated "PE". Instead, they should be labelled with the symbol 417-IEC-5019 ⊕ or by using the two-colour combination GREEN/YELLOW.

## 6. Protection against electric shock

### 6.1 General

The electrical equipment must provide protection against electric shock, namely:

- against direct contact and
- indirect contact.

(Basic protection and error protection)

This must be achieved by using the protective measures outlined in 6.2 (basic protection) and 6.3 (error protection). By using PELV in accordance with 6.4, protection against both direct contact and indirect contact is ensured.



# Machines

## 6.2 Basic protection

The measures outlined in 6.2.2 or 6.2.3 and, where applicable, 6.2.4, must be applied to each circuit or each part of the electrical equipment.

### 6.2.2 Protection via enclosures

Active parts must be positioned within enclosures which meet the relevant requirements from sections 4, 11 and 13. For top covers of enclosures that are readily accessible, protection against direct contact, protection category IP 4X or IP XXD, must be met as a minimum requirement (see IEC 60529).

It must only be possible to open an enclosure (i.e. opening doors, removing lids, covers and the like) if one of the following conditions is met:

- a) Use of a key or tool for access by electricians or electrical staff if switching off the equipment is inappropriate. The master switch may be switched with the door open, if necessary.
- b) Disconnection of active parts within the enclosure before the enclosure can be opened. This can be achieved by locking the door with an isolator (e.g. master switch) so that the door may only be opened if the isolator is open, and the isolator may only be activated when the door is closed. However, it is permissible for electrical staff to override the lock via a special device or tool as per the supplier's specifications, provided:
  - it is possible at all times to open the isolator whilst the lock is overridden, and
  - when the door is closed, the lock is automatically reactivated.

If more than one door provides access to active parts, this requirement should be applied analogously. All parts which remain live after disconnection must provide protection against direct contact, protection category IP 2X or IP XXB (see IEC 60 529), as a minimum requirement. The mains connection terminals of the master switch are exempted from this ruling, provided the latter is housed in a separate enclosure.

- c) Opening without using a key or tool and without deactivating the active parts must only be possible if all active parts are protected against direct contact in accordance with protection category IP 2X or IP XXB (see IEC 60 529) as a minimum requirement. If covers provide this protection, they must either only be removed using a tool, or else they must automatically deactivate all protected active parts when the cover is removed.

# Machines

## 8.2 PE conductor system

### 8.2.1 General

The PE conductor system consists of:

- the PE terminal (see 5.2)
- the conductive structural parts of the electrical equipment and the machine, and
- the PE conductors in the machine equipment.

All parts of the PE conductor system must be designed in such a way that they are capable of withstanding the highest thermal and mechanical stresses from earth-fault currents which could flow in the respective part of the PE conductor system. A structural part of the electrical equipment or the machine may serve as part of the PE conductor system, provided the cross-section of this part is at least equivalent, in electrical terms, to the cross-section of the copper conductor required.

### Parts which need not be connected to the PE conductor

It is not necessary to connect exposed conductive parts to the PE conductor system if these are mounted in such a way that they do not pose any risk because:

- they cannot be contacted over a large area or surrounded by a person's hand and have small dimensions (less than approximately 50 mm x 50 mm)  
or
- they are arranged in such a way that contact with active parts or an insulation fault is unlikely.

This applies to small parts such as screws, rivets and identification labels, and to parts within enclosures, irrespective of their size (such as electromagnets of contactors or relays, and mechanical parts of devices).

### 8.2.2 PE conductors

PE conductors must be identifiable in accordance with 13.2.2.

Copper conductors should be used. If another conductor material is used instead of copper, the electrical resistance per unit of length must not exceed that of the permissible copper conductor. Such conductors must have a cross-section of no less than 16 mm<sup>2</sup>.

The cross-section of PE conductors must be determined in accordance with the requirements of IEC 60 364-5-54, section 543 or EN 61439-1, chapter 8, subsection 8.4.3.2.3, depending on which applies.

This requirement is met in most cases if the ratio between the cross-section of the external conductor and that of the corresponding PE conductor connected to the part of the equipment matches Table 1.

# Machines

## 8.2.3 Continuity of the PE conductor system

All exposed conductive parts in the electrical equipment and the machine(s) must be connected to the PE conductor system.

If electrical equipment is attached to lids, doors or cover plates, the continuity of the PE conductor system must be ensured. This must not be dependent upon mounting components, hinges or support rails. The PE conductor(s) must belong to the conductors supplying the equipment.

If no electrical equipment is attached to lids, doors or cover plates or if only PELV circuits are present, then metal hinges and the like shall be considered adequate to ensure continuity.

If a part is removed for some reason (e.g. regular servicing), the PE conductor system for the remaining parts must not be interrupted.

## 8.2.4 PE conductor connection points

- All PE conductors must be connected in compliance with 13.1.1. PE conductors must not be connected to connection parts used to secure or connect devices or parts.
- Each PE conductor connection point must be labelled as such using the symbol IEC 60 417-5019. Optionally, terminals for the connection of PE conductors may be indicated as such via the two-colour combination GREEN/YELLOW. The letters “PE” are reserved for the terminal used to connect the external PE conductor (see 5.2).

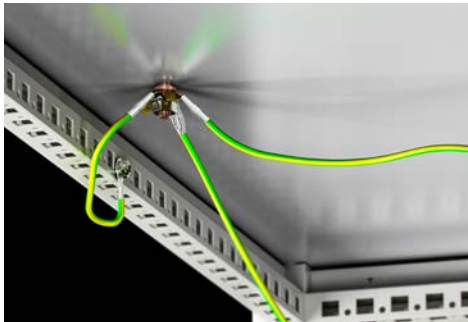

Accessory diversity: Earth straps in various lengths and designs, earth rails, central earth points and PE busbars.



PE/PEN rail for bayed enclosures within a Ri4Power switchgear.

# Machines

## 10.2 Push buttons

### 10.2.1 Colours

Push-button operating parts must be colour-coded in accordance with the following table. The preferred colours for START/ON parts should be WHITE, GREY or BLACK, preferably WHITE.

GREEN may be used; RED must not be used. The colour RED must be used for emergency-off actuators. The colours for STOP/OFF actuators should be BLACK, GREY or WHITE, preferably BLACK. RED is likewise permissible. GREEN must not be used.

WHITE, GREY and BLACK are the preferred colours for push-button actuators which function alternately as START/ON and STOP/OFF push-buttons. The colours RED, YELLOW or GREEN must not be used.

WHITE, GREY and BLACK are the preferred colours for push-button actuators which effect an operation whilst they are actuated and terminate operation when they are released (e.g. jogging). The colours RED, YELLOW and GREEN must not be used.

The colour GREEN is reserved for functions indicating a safe or normal operation. The colour YELLOW is reserved for functions indicating a warning or abnormal status.

The colour BLUE is reserved for functions of urgent significance.

Reset push-buttons must be BLUE, WHITE, GREY or BLACK.

If these are also used as STOP/OFF buttons, the colours WHITE, GREY or BLACK are preferred, preferably BLACK. GREEN must not be used.

### 10.2.2 Labelling

In addition to the functional labelling described in 16.3, it is advisable to label push-buttons with symbols, either adjacent to or – preferably – directly on the actuator, e.g.:

IEC 60 417-5007	IEC 60 417-5008	IEC 60 417-5010	IEC 60 417-5011
	○	ⓘ	⊕
START or ON	STOP or OFF	Push-buttons which optionally function as START and STOP or ON and OFF buttons	Push-buttons which effect a movement when actuated and discontinue the movement when released (i.e. jogging)

## 11.3 Degree of protection

Switchgear must be adequately protected against the ingress of solid foreign bodies and liquids, with due regard for the external influences under which the machine is likely to be operated (i.e. the installation site and the physical ambient conditions), and must provide sufficient protection against dust, coolants, metal swarf and mechanical damage.

The enclosures of switchgear assemblies must have a minimum protection category of IP 22 (see IEC 60 529).

Examples of protection categories for selected applications:

- Vented enclosures that only contain motor starter resistors, dynamic braking resistors or similar equipment: IP 10
- Motors: IP 23
- Vented enclosures containing other equipment: IP 32.

The above are minimum protection categories. A higher protection category may be necessary depending on the siting conditions, e.g. switchgear at a site where low-pressure water jets are used for cleaning should have a minimum protection level of IP 66.

Switchgear which is exposed to fine dust must have a minimum protection category of IP 65.

## 11.4 Enclosures, doors and openings

Locks used to secure doors and covers should be captive. Windows intended for monitoring the display devices inside must be made from a material that is capable of withstanding mechanical stresses and chemical influences, e.g. toughened glass, polycarbonate plates (3 mm thick).

We advise that enclosure doors should have vertical hinges, preferably of a type where the doors can be lifted out.

The opening angle should be at least 95°.

The doors should be no wider than 0.9 m.

Enclosures which are easily entered must be supplied with equipment enabling the individual to escape, e.g. panic locks on the inside of the doors. Enclosures designed for such access, e.g. for servicing purposes, must have a clear width of at least 0.7 m and a clear height of at least 2.0 m.

# Rittal – The System.

Faster – better – everywhere.

## One standard for all switchgear and controlgear DIN EN 61 439

---

**Meter boxes  
Building distributors**



**Switchgear and controlgear  
from wall-mounted enclosures to multi-panel combinations**



The DIN EN 61 439 series of standards outlines the requirements and required documentation for fulfilment of the requirements for all low-voltage switchgear enclosures. The standard is applicable to power distributors, all switchgear and controlgear assemblies, meter boxes and distribution enclosures for private and commercial buildings, assemblies for construction sites, busbar trunking systems and cable distributor enclosures, and switchgear and controlgear assemblies in special zones such as marinas.

**Power distributors**  
**Main distributors**



**Distribution enclosures**



## Brief overview of the use of DIN EN 61 439

For each type of electric power distribution:

- the basic standard with general specifications referred to as “Part 1” and
- the applicable product standard Part 2 – 7 of the distributors is used.

The planning, manufacture (assembly), testing and documentation of a distributor must be carried out in accordance with the applicable standard.

The project planning and construction of a user-specific distributor usually requires five key steps:

1. Definition or selection of influences, application conditions and interface parameters.  
The user should specify these parameters.
2. Draft of a distributor by the manufacturer so that the agreements, parameters and functions applicable to that specific application are met.  
The distributor manufacturer must procure the design verifications for the parts used from the original manufacturer. If these are not available, the distributor manufacturer must provide the design verification.
3. The distributor is assembled with due regard for the documentation supplied by the device manufacturer/original manufacturer of the system.
4. A routine verification must be conducted by the manufacturer for each distributor.
5. The conformity assessment procedure should be carried out.

Compliance with the relevant legislation – in this case, in particular, the Product Safety Act (ProdSG) and the EMC Act – and the associated Declaration of Conformity including CE labelling pre-suppose application of the IEC 61 439 series of standards. The IEC 61 439 series of standards comprises the following standard parts for distributors:

### Planning guide:

DIN EN 61 439-1 supplement 1  
(VDE 0660-600-1 supplement 1):  
Guide to the specification of distributors.

### Basic standard:

DIN EN 61 439-1 (VDE 0660-600-1):  
General specifications

### Product standards:

- DIN EN 61 439-2 (VDE 0660-600-2):  
Power switchgear assemblies
- DIN EN 61 439-3 (VDE 0660-600-3):  
Distribution enclosures
- DIN EN 61 439-4 (VDE 0660-600-4):  
Assemblies for construction sites
- DIN EN 61 439-5 (VDE 0660-600-5):  
Assemblies in power distribution in public networks
- DIN EN 61 439-6 (VDE 0660-600-6):  
Busbar trunking systems
- DIN EN IEC 61 439-7 (VDE 0660-600-7):  
Assemblies for specific applications (such as marinas, electric vehicles charging stations)



# Machines

## Individual verifications and verification methods

The following table shows the admissible techniques for obtaining the individual design verifications.

No.	Characteristic to be verified	DIN EN 61 439-1 Section	Verification possible by		
			Testing	Comparison with a reference design	Assessment
1	Strength of materials and parts:	<b>10.2</b>			
	Resistance to corrosion	<b>10.2.2</b>	■	–	–
	Properties of insulating materials:	<b>10.2.3</b>			
	Thermal stability	<b>10.2.3.1</b>	■	–	–
	Resistance to abnormal heat and fire due to internal electrical effects	<b>10.2.3.2</b>	■	–	■
	Resistance to ultra-violet (UV) radiation				
	Lifting	<b>10.2.4</b>	■	–	■
	Mechanical impact				
	Marking	<b>10.2.5</b>	■	–	–
	Mechanical operation	<b>10.2.6</b>	■	–	–
	<b>10.2.7</b>	■	–	–	
	<b>10.2.8</b>	■	–	–	
2	Protection categories of enclosures	<b>10.3</b>	■	–	■
3	Clearances	<b>10.4</b>	■	–	–
4	Creepage distances	<b>10.4</b>	■	–	–

Continued on next page.

# Machines

No.	Characteristic to be verified	DIN EN 61 439-1 Section	Verification possible by		
			Testing	Comparison with a reference design	Assessment
5	Protection against electric shock and integrity of protective circuits:	<b>10.5</b>			
	Effective continuity of the connection between exposed conductive parts of the assembly in the protective circuit	<b>10.5.2</b>	■	–	–
	Short-circuit withstand strength of the protective circuit	<b>10.5.3</b>	■	■	–
6	Incorporation of switching devices and components	<b>10.6</b>	–	–	■
7	Internal electrical circuits and connections	<b>10.7</b>	–	–	■
8	Terminals for external conductors	<b>10.8</b>	–	–	■
9	Dielectric properties: Power-frequency withstand voltage Impulse withstand voltage	<b>10.9</b>			
		<b>10.9.2</b>	■	–	–
		<b>10.9.3</b>	■	–	■
10	Temperature-rise limits	<b>10.10</b>	■	■	■
11	Short-circuit withstand strength	<b>10.11</b>	■	■	–
12	Electromagnetic compatibility	<b>10.12</b>	■	–	■

Taken from IEC 61 439-1, Table D1, Appendix D

# Rittal – The System.

Faster – better – everywhere.



### Quick guide to EMC/RF-shielded enclosures and the CE symbol

#### What is meant by EMC?

Electromagnetic compatibility (EMC) is the ability of an electrical appliance to operate satisfactorily in its electromagnetic environment without adversely affecting this environment, which may also contain other equipment.

High packaging densities in electronic assemblies and ever-increasing signal processing speeds often cause faults in complex electronic equipment, measurement and control systems, data processing and transmission systems and communications technology, which are attributable to electromagnetic influences.

Another aspect that does not involve interference with or destruction of neighbouring equipment or facilities is the prevention or reduction of unwanted radiation of information requiring protection (compromising radiation) to avoid unauthorised data or intelligence gathering (for espionage purposes in industry or by security authorities).

#### Basic EMC concepts

- **Electromagnetic interference** is the effect of electromagnetic factors on circuits, appliances, systems or living things.
- **Interference source** refers to the origin of interference.
- **Potentially susceptible equipment** refers to electrical equipment whose function may be affected by interference factors.
- **Coupling** refers to the interaction between circuits, where energy can be transmitted from one circuit to another. Interference is an electromagnetic factor which may induce an undesirable influence in an electrical installation (interference voltage, current or field strength).

#### Interference sources and interference factors

Interference sources may be divided into:

- Internal sources of interference
  - Artificial, i.e. technically induced
- External sources of interference
  - Natural, e.g. lightning, electrostatic discharges
  - Artificial, i.e. technically induced.

In the case of technically induced interference sources, a distinction must be made between the effects of electromagnetic factors created and used for business purposes (such as radio transmitters, radar etc.), and electromagnetic factors which occur within the context of operations or in the event of a failure which are not purposely generated (e.g. spark discharges on switch contacts, magnetic fields around heavy currents etc.).

Interference may take the form of voltages, currents, or electrical, magnetic and electromagnetic fields, which may either occur continuously, periodically, or randomly in a pulse shape.

## Special topics

### In low-voltage networks, the following applies:

- The most interference-intensive temporary events are caused in low-voltage networks by the switching of inductive loads, e.g. power tools, household electrical appliances, fluorescent lamps.
- The most dangerous overvoltages (according to level, duration and power content) are caused by fuses tripping in the event of a short circuit (duration in the millisecond range).

### Influence mechanisms and countermeasures

A distinction can be made between the following types of coupling influence:

- Conducted influence
- Field-bound influence
  - Field influence
  - Radiation influence.

### Field-bound interference (low frequency)

Very low-frequency currents cause a low-frequency magnetic field which may induce interference voltage or initiate interference via direct magnetic effects (magnetic memory in computers, monitors, sensitive electromagnetic test equipment such as EEG). Low-frequency electric fields of high intensity may be generated by low-frequency high voltages (high-voltage overhead lines), resulting in interference voltages (capacitive interference). Of practical significance are magnetic fields, the effects of which can be reduced via

- Shielded cables
- Shielding enclosures (the decisive material property is that of permeability, which is too low in the case of sheet steel; nickel iron, for example, is much better).

### Radiation influence (high-frequency)

The electromagnetic waves which radiate from electrical circuits in an open space can produce interference voltages, whereby such interference must then be considered in relation to the distance to its source (near field or distant field).

In a near field, either the electrical component (E) or the magnetic component (H) of the electromagnetic field will predominate, depending on whether the source of the interference carries high voltages and low currents, or high currents and low voltages. In a distant field, generally speaking, E and H can no longer be considered separately. Interference can be reduced via:

- Shielded cables
- Shielding enclosures (Faraday cage!)

# Special topics

## Enclosure/RF shielding

The requirement profile can be determined using the following check-list.

### Checklist to determine the requirement profile for EMC enclosures

- What types of interference occur in the given application (electric, magnetic or electromagnetic field)?
- What are the limits of interference which may occur in the application (field strengths, frequency range)?
- Can the requirements be met by a standard enclosure or an RF shielded enclosure (comparison with attenuation diagrams)?
- Are there any other EMC requirements (shielding within the housing, special potential equalisation within the enclosure, etc.)?
- Are there any other mechanical requirements (cut-outs, glazed doors/viewing windows, cable glands, etc.)?

Every sheet metal enclosure already offers good basic shielding within a broad frequency range, i.e. attenuation of electromagnetic fields. For large enclosures, medium shield attenuation can be achieved via cost-effective measures to create multiple conductive connections between all enclosure parts.

High shielding attenuation levels in the frequency range above approx. 5 MHz can be achieved via special seals which conductively connect the conductive inner surfaces of doors and removable panels, roof and gland plates to the conductive sealing edges of the enclosure body or frame, largely in a slot-free manner. The higher the frequencies occurring, the more critical openings in the enclosure become.



Automatic potential equalisation of the roof, rear panel and sides acts as earthing when Rittal climate control devices and Rittal fan-and-filter units are installed.



Combined rail for strain relief and EMC contacting of inserted cables.

# Special topics

## How do I interpret an EMC diagram?

In all diagrams, the attenuation value of an enclosure is obtained from the anticipated interference frequency and the nature of the interference field (electrical field E, magnetic field H or electromagnetic field). For example, in the diagram below, the following attenuation values are obtained with a frequency of 100 MHz.

- Point 1:  
Electromagnetic field, high:  $a_1 \approx 48$  dB
- Point 2:  
Electromagnetic field standard:  $a_2 \approx 22$  dB

In all diagrams, the level of attenuation "a" is shown on the Y axis (vertical) in the unit "dB".

This unit indicates the logarithmic ratio between the field in the environment and the field in the enclosure interior. The frequency band is entered on the X axis (horizontal) on a logarithmic scale. Attenuation "a" is obtained using the following equation:

$$a = 20 \log \frac{E_0}{E_1} \text{ and } \left. \begin{array}{l} \text{Index 0 for unshielded values} \\ \text{Index 1 for shielded values} \end{array} \right\}$$

$$a = 20 \log \frac{H_0}{H_1} \text{ with } \left. \begin{array}{l} \text{Index 0 for unshielded values} \\ \text{Index 1 for shielded values} \end{array} \right\}$$

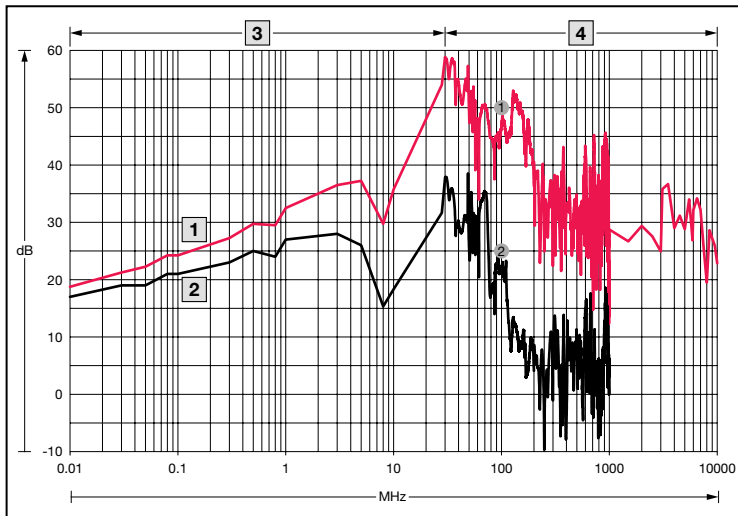

- MHz = Frequency
- dB = RF attenuation
- 1 EMC enclosure
- 2 Standard enclosure
- 3 H field
- 4 EM-Welle

Table of examples

Attenuation in dB	Ratio inside/outside
6	1/2
20	1/10
40	1/100
60	1/1000

# Special topics

## CE label

### What does CE stand for?

The abbreviation stands for European Communities (= Communautés Européennes) and documents a product's compliance with the respective EU Directives.

### Fundamental principles

CE labelling is not the same as certification, where a manufacturer voluntarily has the positive properties of his products confirmed by test institutes. It is a legally prescribed label for all products which meet EU Directives.

The main aim of CE labelling is to eliminate trade barriers within EU Member States. The CE symbol is an administrative symbol, and was not originally intended for consumers and end clients. It serves as an indication to market supervisory authorities that the labelled products meet the requirements of the technical harmonisation directives, particularly safety requirements.

It should be viewed as a kind of "technical passport" for certain products within the European Economic Area.

CE labelling is based on the harmonisation concept of the European Union and the associated growing importance of European standardisation. The main content is mutual recognition of existing national regulations, standards and specifications. This is particularly for the purpose of consumer protection, with the main emphasis on health, safety and the environment.

### What does this mean in concrete terms for Rittal products?

Enclosures that are intended and used for low-voltage switchgear enclosures in accordance with IEC 61 439 are subject to the provisions of the Low Voltage Directive, evaluated in accordance with DIN EN 62 208, and labelled with a CE mark.

Empty housings for general and IT applications and mechanical accessory components are not currently subject to any valid EU Directive.

Electrical appliances must meet all the relevant EU Directives with respect to their hazard potential, fields of application and the Directive definitions.

All Rittal products which meet these Directives are labelled with the CE symbol, either on the product itself or on the insert. This symbol is also reproduced in the manual. Upon request, a corresponding declaration of conformity (in German or English) will be issued.

### Directives which apply to Rittal products primarily include:

- The EMC Directive 2014/30/EU
- The Low Voltage Directive 2014/35/EU
- The Machinery Directive 2006/42/EC



**Rittal – The System.**

Faster – better – everywhere.

## Enclosures for explosion protection

---



# Special topics

## Fundamental principles and basic facts on explosion protection

Many segments of the chemical and petrochemical industries, as well as industrial mills and the landfill gas extraction and mining industries, have certain areas where mixtures of combustible materials and oxygen may occur rarely, occasionally or frequently.

Measures designed to prevent the occurrence of potentially explosive atmospheres are described as primary explosion protection measures.

Areas where a hazardous, potentially explosive atmosphere may arise are classified into zones according to the probability of such an atmosphere arising.

Gas atmospheres are classified into zones 0, 1 and 2, whilst dust atmospheres are classified into zones 20, 21 and 22.

### Zone classification







Zone		Definition	Guideline values (non-standardised)
0	20	Constant or long-term or frequent risk	> 1000 h/a
1	21	Occasional risk	between 10 and 1000 h/a
2	22	Rare risk	< 10 h/a

If it is additionally necessary to install electrical equipment at such locations, it must be designed in such a way as to prevent ignition and hence explosion of the mixtures.

## Special topics

### Types of ignition protection

If the occurrence of a potentially explosive atmosphere cannot be excluded by means of primary explosion protection measures, then secondary protective measures must come into play. Such measures prevent the ignition of the atmosphere in a variety of ways, and are known as protection types.

	Protection type (selection)		Application areas (selection)	Standard
	Requirements			DIN EN 60 079
	Oil immersion	o	Electronics, transformers, capacitors, relays	DIN EN 60 079-6
	Sand filling	q	Electronics, transformers, capacitors, relays	DIN EN 60 079-5
	Encapsulation	m	Electronics, transformers, capacitors, relays	DIN EN 60 079-18
	Pressurisation	p	Machines, motors, enclosures	DIN EN 60 079-2
	Flameproof enclosure	d	Motors, switchgear, power electronics	DIN EN 60 079-1
	Increased safety	e	Terminals, cases, lights, motors	DIN EN 60 079-7
	Intrinsic safety	i <sup>1)</sup>	Electronics, measurement and control systems	DIN EN 60 079-11
	"Non- trigger"	n <sup>2)</sup>	Motors, cases, lights, electronics	EN 60 079-15

<sup>1)</sup> ia for use in zone 0, 1, 2; ib for use in zone 1, 2

<sup>2)</sup> For use in zone 2

Simple electrical equipment in intrinsically safe circuits: These include energy sources which generate no more than 1.5 V, 100 mA and 25 mW, and energy stores with precisely defined parameters and passive components such as switches, distributor boxes, terminals etc.

Such simple electronic equipment must conform to standard DIN EN 60 079-11 and does not require a licence.

# Special topics

## Labelling of explosion-protected electrical equipment to DIN EN 60 079

Design designations



### 1 ATEX label

Ex symbol: Symbol for electrical equipment which has been built to European standards

#### Equipment group I: Mining; equipment group II: other areas

Zone classification	0	20	1	21	2	22	Mining
Hazardous explosive atmosphere	Constantly, frequently or long-term		Occasionally		Rarely and short-term		
Equipment category	1G	1D	2G	2D	3G	3D	M1 or M2

### 2 Protection type

Protection type	Alternative symbol	Zone
Increased safety "e"	eb	1
	ec	2
Flameproof enclosure "d"	da	0
	db	1
	dc	2
Pressurisation "p"	pxb	1.21
	pyb	1.21
	pzs	2.22
Intrinsic safety "i"	ia	0.20
	ib	1.21
	ic	2.22
Oil immersion "o"	ob	1
	oc	2
Sand filling "q"	q	1
Encapsulation "m"	ma	0.20
	mb	1.21
	mc	2.22
Protection type "n"	nA	2
	nC	2
	nR	2
Protection via enclosures "t"	ta	20
	tb	21
	tc	22

### 3 Group/Hazardous substances

#### Areas at risk of firedamp

Group I	Methane
---------	---------

#### Areas at risk of gas explosions

Group II	IIA	Propane
	IIIB	Ethylene
	IIC	Hydrogen

#### Explosive dust atmospheres

Group III	IIIA	Flammable lint
	IIIB	Non-conductive dust
	IIIC	Conductive dust

### 4 Max. surface temperature

#### Explosive gas atmospheres: Temperature classes

Group I	Methane
---------	---------

#### Explosive gas atmospheres

450 °C	T1
300 °C	T2
200 °C	T3
135 °C	T4
100 °C	T4
85 °C	T6

#### Explosive dust atmospheres: Surface temperature

T ...°C (e.g.: T 80 °C)

### 5 Appliance category and EPL (equipment protection level)

Zone classification	0	20	1	21	2	22	Mining
EPL (IEC/EN 60079-0)	Ga	Da	Gb	Db	Gc	Dc	Ma or Mb

# Special topics

## Additional labelling to EC Dir. 94 / 9 (ATEX 100a) or DIN EN 60 079



0102

II (1) G

Prototype-tested to EC Dir. 94 / 9 (ATEX 100a)  
or DIN EN 60 079

Test centres (excerpt) in Europe and North America

Test centre	Country	Identifier
PTB	Germany	0102
DMT (BVS)	Germany	0158
DQS	Germany	0297
BAM	Germany	0589
EECS (BASEEFA)	UK	0600
SCS	UK	0518
INERIS	France	0080
LCIEw	France	0081
KEMA	Netherlands	0344
CESI	Italy	–
INIEX	Belgium	–
DEMKO	Denmark	–
NEMKO	Norway	–
UL	USA	–
FM	USA	–
CSA	Canada	–

### Application area

Electrical equipment which is certified to the ATEX 100a guidelines is given an additional code which refers to the place of use (or in the case of associated electrical equipment, defines where the signal cables may lead to). The component group is shown first, followed by the category and finally a reference to the atmosphere (gas and/or dust). The following sub-division applies to equipment group II:

Level of safety	Category 1 Very high		Category 2 High		Category 3 Normal	
Adequate safety	By 2 protective measures/for 2 faults		For frequent malfunctions/for 1 fault		For fault-free operation	
Use in	Zone 0	Zone 20	Zone 1	Zone 21	Zone 2	Zone 22
Atmosphere	G (gas)	D (dust)	G (gas)	D (dust)	G (gas)	D (dust)

## Special topics

### Some key safety figures for combustible gases and vapours (selection)

Name of substance	Ignition temperature °C	Temperature category	Explosion group
Acetaldehyde	140	T 4	II A
Carbon disulphide	95	T 6	II C (1)
Hydrogen sulphide	270	T 3	II B
Hydrogen	560	T 1	II C (2)
Ethylene	425	T 2	II B
Ethylene oxide	440	T 2	II B
Benzines, petrol fuels, initial boiling temperature < 135 °C	220 to 300	T 3	II A
Special benzines, initial boiling point > 135°C	220 to 300	T 3	II A
Benzole (pure)	500	T 1	II A
Diesel fuels DIN EN 590: 2004	220 to 300	T 3	II A
Jet fuels	220 to 300	T 3	II A
Fuel oil EL DIN 51 603-12003-09	220 to 300	T 3	II A
Fuel oil L DIN 51 603-21992-04	220 to 300	T 3	II A
Fuel oils M and S DIN 51 603-3 2003-05	220 to 300	T 3	II A

## Background information on UL 508 and UL 508A

### Application areas for UL 508 and UL 508A

UL 508 describes industrial control equipment and is therefore the decisive standard for the assessment of Rittal power distribution (SV) components. By contrast, UL 508A describes industrial control panels and is the decisive standard for the construction of control enclosures for the switch-gear manufacturer.

Standard UL 508A makes a distinction between feeder circuits and branch & control circuits. Generally speaking, the term “feeder circuits” refers to the part of the circuit located at the supply end before the last over-current protective device. Increased requirements with regard to creepage distances and clearances apply to this part of the circuit. The term “branch & control circuits” refers to the part of the circuit located after the last over-current protective device. When using busbar systems, it is important to know whether the application is in the feeder section or the branch section, as the requirements governing the required creepage distances and clearances are significantly higher for feeder circuits.

### Important notes for the use of busbar systems to UL 508

One of the principal changes in UL 508A is the amendment to the required creepage distances and clearances for feeder circuits. The following distances are required for applications > 250 V:

Between phases:

- Creepage distance 50.8 mm (2 inches)
- Clearance 25.4 mm (1 inch)

■ Between phase and earthed, uninsulated metal parts:

- Creepage distance 25.4 mm (1 inch)
- Clearance 25.4 mm (1 inch)

Rittal RiLine complies with these requirements. All busbar connection adaptors and component adaptors (OM adaptors with standard AWG connection cables and circuit-breaker adaptors) in the new system have been designed in accordance with these requirements. However, users should bear in mind a small number of differences from the IEC version:

- Special UL busbar supports for flat bars and Rittal PLS with increased creepage distances and clearances.
- Use of the Rittal RiLine base tray is required in order to comply with the necessary minimum distances from the mounting plate.

# Worldwide

## 1. Rated currents

For untested busbar applications, UL 508A specifies a current carrying capacity of 1000 A/inch<sup>2</sup> (1.55 A/mm<sup>2</sup>) in the absence of testing. This value may be higher if the product or application has undergone suitable testing. Rittal has conducted extensive testing in this respect in order to give users the maximum benefits when using the RiLine busbar system. The benefit of such testing is that busbar systems with higher rated currents may be used than permitted by the default value. For example, a busbar with dimensions 30 x 10 mm can take 700 A instead of 465 A.

## 2. Terminals for factory or field wiring

In accordance with the UL standards, connection terminals may be approved for factory or field wiring. If a terminal is approved for factory wiring, it may only be used in switchgear assembly by suitably trained professionals. If connection terminals are to be used in the field (e.g. on a construction site), the component must be approved for field wiring. For this reason, the terminals of RiLine busbar connection and component adaptors meet the requirements for field wiring.

### Definition of creepage distances and clearances:

- A** Creepage distance between active conductors/busbars
- B** Clearance between active conductors/busbars
- C** Creepage distance between active conductors/busbars and earthed metal parts
- D** Clearance between active conductors/busbars and earthed metal parts

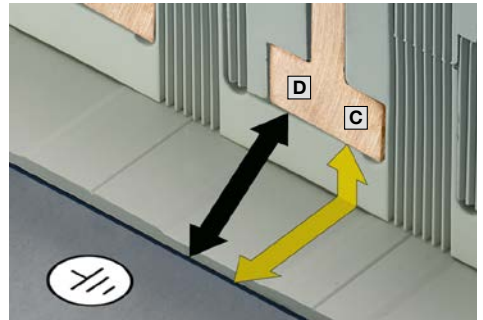
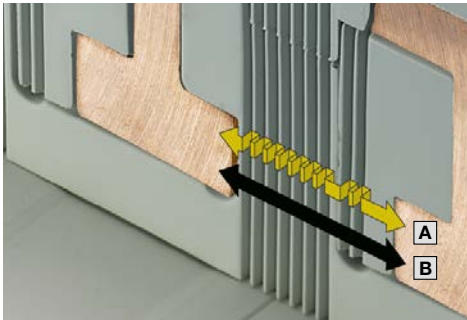



## Approvals and permits

### **Product certifications and approvals are pivotal to the global acceptance of industrial products.**

Rittal products meet the highest internationally recognised quality standards. All components are subjected to the most stringent testing in accordance with international standards and regulations.

The consistently high product quality is ensured by a comprehensive quality management system. Regular production inspections by external test institutes also guarantee compliance with global standards

Precise details of the test symbols allocated to our products can be found in our catalogues and brochures.

In most cases, the approved symbols are also displayed on the rating plates or products as proof of the approvals and licences.

Furthermore, copies of the marks licence badges or test certificates are available directly from your personal Rittal advisor.

Additional tests conducted at our own accredited laboratories, such as the mechanical load-bearing capacity of enclosures, are published in our own load capacity brochures. These brochures contain detailed information to assist you with the use of Rittal products. Copies of this documentation are likewise available from your Rittal advisor.

Further interesting information and product documentation can be found on the Internet at [www.rittal.com](http://www.rittal.com)

## Earthquake protection

**Enclosures which are subject to extreme dynamic loads, such as earthquakes, place correspondingly high demands on the stability and strength of the enclosure design, especially in critical supply areas (electricity, water, information).**

In connection with earthquake risks, the standards applied by the American telephone companies – Network Equipment-Building System (NEBS), Telcordia Technologies (formerly BELLCORE) Generic Requirements GR-63-CORE – have become established worldwide, since their test specifications cover practically the whole contents of other standards.

The geographical regions of a country are allocated to an appropriate earthquake risk zone. The Telcordia risk zones (see chart) refer to the United States and divide regions into zones 0 – 4. Zone 0 has no earthquake activity, while in zone 4, significant earthquake activity is to be expected.

The German standards, on the other hand, define only three zones, though these are essentially equivalent to the zones 1 and 2 of the Telcordia specifications.

Rittal VX25 standard enclosures with mounting plates were tested by an independent institute on the basis of Telcordia GR-63-CORE. VX25 standard enclosures with a weight load of 185 kg (installed on the mounting plate) subsequently received certification of their suitability for use up to zone 2. Certification for zone 4 with up to 500 kg was obtained by fitting special earthquake accessories.



# Worldwide

We generally recommend that earthquake-proof enclosures should be tested on a customer-specific basis, i.e. using the customer's own installed equipment.

Important information for the design and testing of earthquake-proof enclosures includes:

- Earthquake zone in which the enclosure is to be used
- Max. weight of the installed components
- Method of component installation (mounting plate, 482.6 mm (19") mounting angles, etc.)
- Are there any limitations with regard to dimensions? (earthquake resistance often entails selection of a wider or deeper enclosure version)

Rittal will be happy to advise you on the configuration of your earthquake-proof enclosure.

- 1 Zone 4 door reinforcement
- 2 VX25 standard frame
- 3 Zone 4 corner reinforcement
- 4 Zone 4 diagonal reinforcement
- 5 Zone 4 horizontal reinforcement
- 6 Zone 4 base/plinth

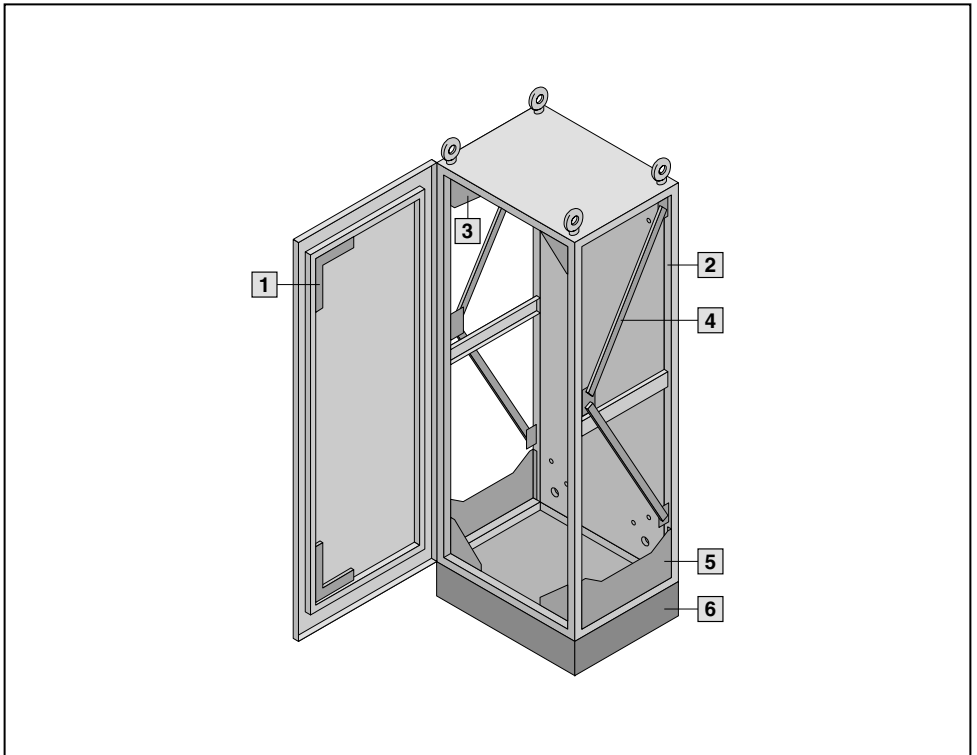

# Rittal – The System.

Faster – better – everywhere.



# Labelling

---

	Page
Labelling of components	
Colour coding for push-button actuators and its meaning .....	102
Colour coding of resistors .....	103
Labelling of terminals and power cables .....	104
Labelling in plans	
Graphical symbols for electrical installations	
to DIN EN 60 617/IEC 60 617 .....	106
Code letters for the labelling of equipment	
to DIN EN 81346-2/IEC 81346-2 .....	119
Labelling for test purposes	
Important marks of conformity and symbols .....	121

# Labelling of components

## Colour coding for push-button actuators and its meaning

Colour	Meaning	Explanation	Sample applications
RED	Emergency	Actuate in a dangerous condition or emergency	Emergency off, initiation of emergency off functions
YELLOW	Abnormal	Actuate in an abnormal condition	Intervention to suppress abnormal condition. Intervention to re-start an interrupted procedure.
GREEN	Safe	Actuate in a safe condition or to prepare for a normal status	
BLUE	Compulsory	Actuate in a condition requiring a compulsory action	Reset function
WHITE	No special meaning assigned	For the general initiation of functions except emergency off (see notes)	START/ON (preferred) STOP/OFF
GREY			START/ON STOP/OFF
BLACK			START/ON STOP/OFF (preferred)

Note: Provided an additional method of labelling (e.g. structure, form, position) is used to mark push-button actuators, the same colours WHITE, GREY or BLACK may be used for different functions, e.g. WHITE for START/ON and STOP/OFF actuators.

# Labelling of components

## Colour coding of resistors

Colour	1. ring $\hat{=}$ 1st digit	2. ring $\hat{=}$ 2nd digit	3. ring $\hat{=}$ multiplier	4. ring $\hat{=}$ tolerance
Black	–	0	1	–
Brown	1	1	10	$\pm 1\%$
Red	2	2	$10^2$	$\pm 2\%$
Orange	3	3	$10^3$	–
Yellow	4	4	$10^4$	–
Green	5	5	$10^5$	$\pm 0.5\%$
Blue	6	6	$10^6$	–
Violet	7	7	$10^7$	–
Grey	8	8	$10^8$	–
White	9	9	$10^9$	–
Gold	–	–	0.1	$\pm 5\%$
Silver	–	–	0.01	$\pm 10\%$
Colourless	–	–	–	$\pm 20\%$

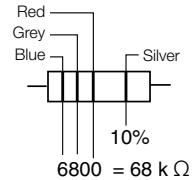
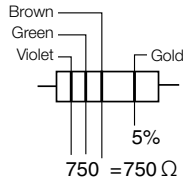
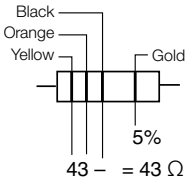

# Labelling of components

## Labelling of terminals and power cables

For DC current				For three-phase and AC current				
Positive conductor L+ Negative conductor L- Neutral conductor M				Rotary current motor	Outer conductor		L1, L2, L3	
				Single-phase current		Neutral conductor		N
						Delta voltage	Connection to three-phase network	L1, L2 or L2, L3 or L3, L1
							Independent network	L1, L2
		Star voltage		N with L1 or L2 or L3				
Armature		A-B	Rotary current motor	Interlinked	Primary U, V, W	Secondary U, V, W		
Parallel winding for self-excitation		C-D		Unlinked	Primary U-X, V-Y, W-Z	Secondary u-x, v-y, w-z		
Series winding		E-F	Single-phase current	General	U-V	-		
Commutating or compensating winding Commutating winding with compensating winding		G-H		Main winding	U-V	-		
Separate commutating and compensating winding	Commutating winding	GW-HW		Auxiliary winding	W-Z	-		
	Compensating winding	GK-HK	Multi-phase current	Neutral or star point	N	n		
Separately excited field windings		J-K	DC exciter winding		J-K			
Starter	Terminal for connection to	Mains	L	Secondary starter	Rotary current motor	Interlinked	u, v, w	
		Armature	R			Unlinked	u-x, v-y, w-z	
		Parallel winding	M	Primary starter	Rotary current motor	Connected in star point	X, Y, Z	
Parallel winding	s	Between mains and motor	U-X, V-Y, W-Z					
Field rheostat for voltage and speed control	Terminal for connection to	Armature or mains	t	Field rheostat	DC current	Terminals for connection to	Field winding	s
		Armature or mains for short-circuit	q				Exciter mains to field rheostat	t
							Exciter mains short-circuit	q
Current converter				Primary side K-L		Secondary side k-l		







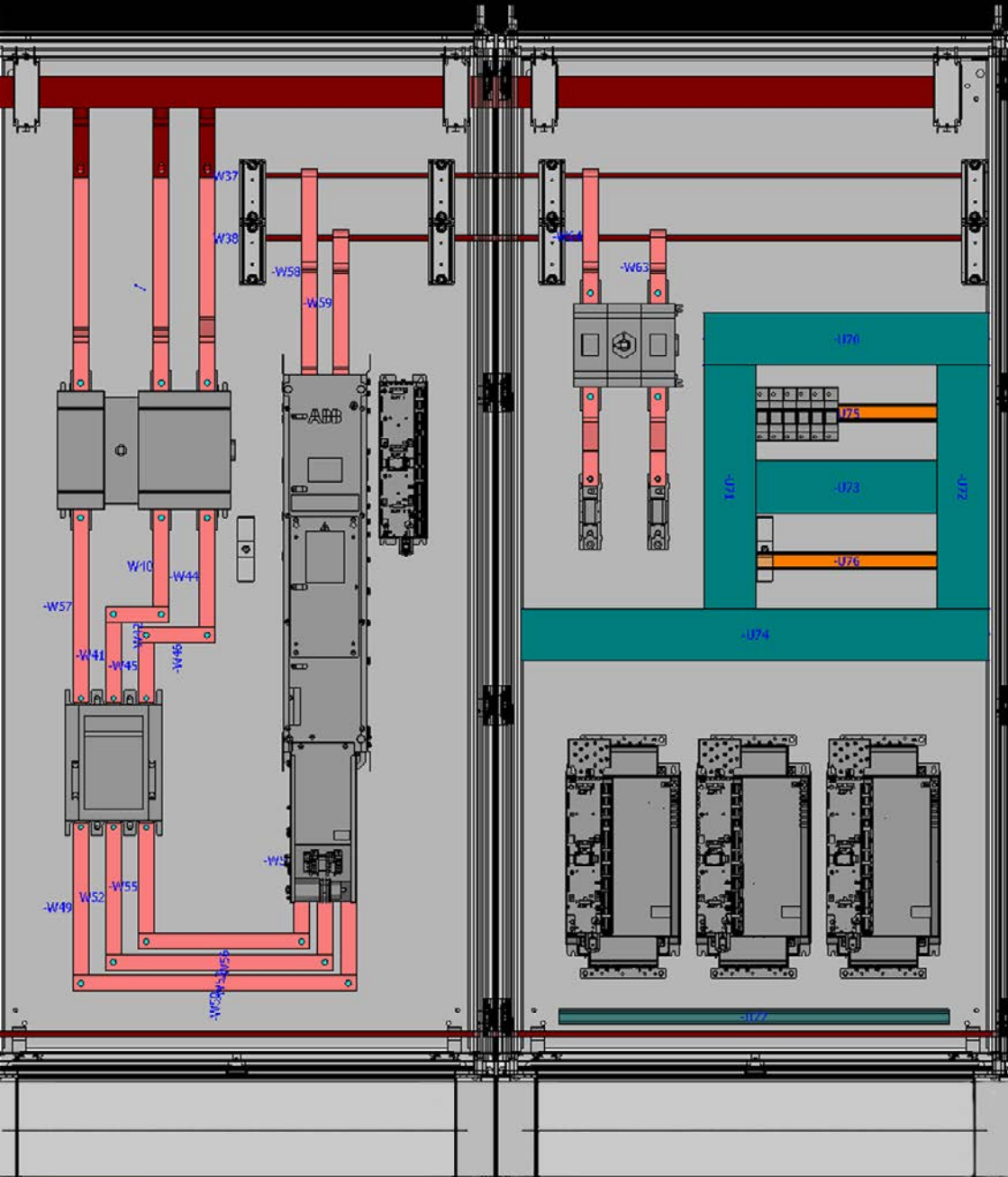













# Rittal – The System.

Faster – better – everywhere.

















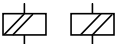

# Labelling in plans

## Graphical symbols for electrical installations to DIN EN 60 617/IEC 60 617

Graphical symbols and description	Graphical symbols and description
 <p>Make contact, normally open contact</p>	 <p>Fuse-switch disconnect</p>
 <p>Break contact, normally closed contact</p>	 <p>Fuse, general</p>
 <p>Change-over contact</p>	 <p>Fuse with labelling of the mains-end connection</p>
 <p>Make contact, two-way make contact with three switching positions</p>	 <p>Surge arresters, voltage fuse</p>
 <p>Drive, general, e.g. for relay, contactor</p>	 <p>Spark gap</p>
 <p>Latching mechanism with electromechanical release</p>	 <p>Double-spark gap</p>
 <p>Normally closed contact, with delayed closing</p>	 <p>Normally closed contact, with delayed opening</p>
 <p>Normally open contact, with delayed opening</p>	 <p>Normally open contact, with delayed closing</p>
 <p>Isolator switch, off-load switch</p>	 <p>Electromechanical drive with two opposite windings</p>





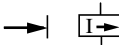

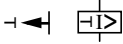
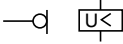
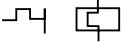

# Labelling in plans

## Graphical symbols for electrical installations to DIN EN 60 617/IEC 60 617

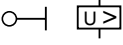
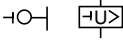
Graphical symbols and description	Graphical symbols and description
 <p>Electromechanical drive, with wattmetric action</p>	 <p>AC relay</p>
 <p>Electromechanical drive, e.g. with specification of an effective winding</p>	 <p>Electromechanical drive with specification of DC current resistance, e.g. 500 Ohm</p>
 <p>Electromechanical drive e.g. with specification of an effective winding, optional portrayal</p>	 <p>Electromechanical drive with specification of the electrical variable</p>
 <p>Electromechanical drive with two equidirectional windings</p>	 <p>Electromechanical drive with natural resonance, e.g. 20 Hz</p>
 <p>Electromechanical drive with two equidirectional windings, optional portrayal</p>	 <p>Thermal relay</p>
 <p>Electromechanical drive with two equidirectional windings, optional portrayal</p>	 <p>Electromechanical drive with pick-up delay</p>
 <p>Polarised relay with permanent magnet</p>	 <p>Electromechanical drive with drop-out delay</p>
 <p>Latching relay</p>	 <p>Electromechanical drive with pick-up and drop-out delay</p>
 <p>Remanence relay</p>	 <p>Reverse-current release</p>

# Labelling in plans



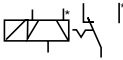
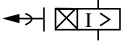
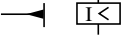

## Graphical symbols for electrical installations to DIN EN 60 617/IEC 60 617

Graphical symbols and description	Graphical symbols and description
 <p>Fault current circuit breaker</p>	 <p>Undervoltage circuit-breaker</p>
 <p>Electrothermal over-current circuit-breaker</p>	 <p>Undervoltage circuit-breaker with delayed release</p>
 <p>Overvoltage circuit-breaker</p>	 <p>Fault-voltage-operated circuit-breaker</p>
 <p>Electromechanical drive with two switching positions</p>	 <p>Electromechanical drive, excited</p>
 <p>Electromechanical drive with two switching positions, optional portrayal</p>	 <p>Normally open contact with automatic return, actuated</p>
 <p>Electromechanical drive with three switching positions</p>	 <p>Remanence relay If voltage is applied to the winding connection with an * (asterisk), then contact is made at the point on the contact element marked with an * (asterisk).</p>
 <p>Electromechanical drive with delayed release</p>	
 <p>Undercurrent circuit-breaker</p>	





# Labelling in plans

## Graphical symbols and description



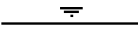
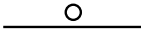

### General

	DC current		Audio-frequency AC current
	AC current, particularly technical AC current		High-frequency AC current
3/ N 50 Hz	Three-phase current with neutral conductor and specification of the frequency, e.g. 50 Hz		

## Conductor systems and labelling for types of installation

	Conductor, general		Overground conductor, e.g. overhead cable
	Conductor, mobile		Conductor on isolators
	Underground conductor, e.g. earth cable		Conductor in electrical installation pipe

















## Labelling of the intended purpose with cables

	Heavy current cable, neutral conductor (N), middle conductor (M)		Telecommunications cable
	PE (PE), PEN conductor (PEN), equipotential bonding conductor (PL)		Radio cable
	Signal cable		

# Labelling in plans

## Graphical symbols for electrical installations to DIN EN 60 617/IEC 60 617



















### Graphical symbols and description

Infeed, earth			
	Socket		Sealing end, distribution point (short side = cable entry)
	Cable coming from below or leading downwards		Power service box, general
	With supply pointing downwards		Ditto, specifying the protection category to IEC 60 529, e.g. IP 44
	With supply from below		Distributor, switchgear
	Cable routed downwards and upwards		Frame for equipment, e.g. case, enclosure, control panel
	With supply pointing upwards		Earthing in general
	Conductor connection		Connection point for PE conductor to VDE 0100
	Tapping box or distributor box		Mass (Graphical symbols to IEC 117)

# Labelling in plans

## Graphical symbols and description

### Power supply equipment, converters

	Element, accumulator or battery		Fuse, general
	Ditto, specifying the polarity and voltage, e.g. 6 V		Fuse, 3-pole
	Transformer, e.g. bell transformer 230/5 V		Fuse specifying the rated current, e.g. 10 A
	Converter, general		Switch, normally open contact, general
	Rectifier, e.g. AC current power pack		Switch specifying the protection category to IEC 60 529, e.g. IP 40
	Inverter, e.g. pole changer, chopper		Miniature circuit-breaker (m.c.b.)
	Fault-current circuit-breaker, 4-pole		Earth-leakage circuit-breaker (ELCB)
	Motor circuit-breaker, 3-pole		Overcurrent relay Priority switch
	Undervoltage circuit-breaker		EMERGENCY OFF switch

# Rittal – The System.

Faster – better – everywhere.





















# Labelling in plans

## Graphical symbols for electrical installations to DIN EN 60 617/IEC 60 617

### Graphical symbols and description









Installation switches			
	Switch, general		Two-circuit switch, single-pole
	Switch with control lamp		Changeover switch, single-pole
	One-way switch, single-pole		Intermediate switch, single-pole
	One-way switch, 2-pole		Time-delay switch
	One-way switch, 3-pole		Push-button
	Two-way switch with two off positions, single-pole		Illuminated push-button
	Remote-control switch		Touch switch (two-way switch)
	Proximity switch		Dimmer (one-way switch)

# Labelling in plans







## Graphical symbols for electrical installations to DIN EN 60 617/IEC 60 617

### Graphical symbols and description

#### Plug-and-socket devices

	Single socket without earthing contact		Socket earthing contact, switched
	Double socket		Socket earthing contact, lockable
	Single socket with earthing contact		Telecommunications socket
	Single socket with earthing contact for three-phase current		Aerial socket
	Double socket with earthing contact		

#### Test equipment, display devices, relays and audio frequency ripple control devices

	Meter panel, e.g. with a fuse or 10 A miniature circuit-breaker		Flasher relay, flasher switch
	Time switch, e.g. for switching between electricity tariffs		Audio frequency ripple control
	Time-delay relay, e.g. for stairwell illumination		Audio frequency blocking device

# Labelling in plans

## Graphical symbols and description

### Lights

✕	Light, general	⌵	Maintained emergency light
✕ 5 x 60 W	Multiple lights specifying the number of lights and output, e.g. with 5 lamps, 60 W each	✕	Emergency light in stand-by circuit
✕	Light with switch	⊗	Spotlight
⊗	Light with jumpering for lamp chains	⊗ ✕	Light with additional emergency light in stand-by circuit
✕	Light with variable brightness	⊗ ⌵	Light with additional maintained emergency light



### LED system light







- Optimum illumination of the entire enclosure
- Optionally with clip, screw and magnetic attachment
- A configuration to suit every application

# Labelling in plans





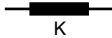
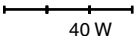

## Graphical symbols for electrical installations to DIN EN 60 617/IEC 60 617

### Graphical symbols and description

#### Discharge lamps and accessories

	Light for discharge lamp, general		Fluorescent lamp with preheating
	Multiple light for discharge lamps specifying the number of lamps, e.g. with 3 lamps		Ballast, general
	Light for fluorescent lamps, general		Ballast, compensated
	Long row of luminaires for fluorescent lamps, e.g. 3 luminaires each 40 W		Ballast, compensated, with audio frequency blocking device
	Long row of luminaires for fluorescent lamps, e.g. 2 luminaires each 65 W		

















#### Signalling devices

	Alarm		Horn
	Buzzer		Siren
	Gong		Indicator light, signal lamp, light signal

# Labelling in plans

## Graphical symbols and description









### Signalling devices

	Group or direction indicator light		Master clock
	Multiple indicator lights, signal lamp panel, e.g. for 6 indicators		Signal master clock
	Acknowledgement indicator, indicator light with cutout button		Card control device; manually actuated
	Call and cutout button		Fire alarm with clock
	Interphone		Push-button fire detector
	Call buttons with name plates		Temperature indicator
	Door opener		Temperature indicator based on the fusible link principle
	Electrical clock, e.g. slave clock		Temperature indicator based on the bimetal principle

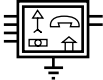
# Labelling in plans

## Graphical symbols for electrical installations to DIN EN 60 617/IEC 60 617

### Graphical symbols and description

Signalling devices			
	Temperature indicator based on the differential principle		Traverse lock for actuation travel in security systems
	Control centre of a fire alarm system for 4 loops in fail-safe circuit, siren system for 2 loops, telephones for both systems		Light beam indicator, light barrier
	Police alarm		Fire detector, automatic
	Watchdog alarm, e.g. with failsafe circuit		Photo-electric switch
	Vibration alarm (vault-type pendulum)		



### Modular signal pillar

inserted with support arm systems using assembly components.

## Labelling in plans

### Code letters for the labelling of equipment to DIN EN 81 346-2/IEC 81 346-2

Device categories, purpose, task	Code letters	Examples
Assemblies, two or more purposes	A	Equipment combinations, touch screen
Converters of non-electrical variables to electrical variables	B	Measurement converters, sensors, microphones, photoelectric components, sound pick-ups, speakers
Capacitors	C	All types of capacitor, hard disk, ROM
(Binary elements, delay and memory devices)	D*	(Digital integrated circuits and components, delay lines, bistable elements, monostable elements, core memory, registers, magnetic tape devices, disk storage)
Miscellaneous	E	Lighting, heaters
Protective equipment	F	Fuses, releases, circuit breakers
Generators	G	Power supply units, batteries, oscillators
Manufacturing a new type of material or a new product	H	Separators, mixers
Signal processing	K	Auxiliary, time and flasher relays
(Inductors)	L*	(Coils, throttles)
Motors	M	Short circuit motor, slipping rotor motor
(Analog components)	N*	(Operational amplifiers, hybrid analog/digital elements)
Display of information	P	Screen, display, horn
Circuit-breakers	Q	Circuit-breakers, miniature circuit-breakers
Resistors	R	Shunt resistors, rheostats, NTC and PTC resistors, throttles, filters
Signal transformation	S	Switches, end switches, control switches
Energy transformation	T	Power transformers, current converters

\* Reserved for future standardisation

# Labelling in plans

## Code letters for the labelling of equipment to DIN EN 81 346-2/IEC 81 346-2

Device categories, purpose, task	Code letters	Examples
Connecting objects	U	Isolators, cable ducts, enclosures
Treatment of materials	V	Packaging machine, coating machine
Conducting and transmitting energy, signals	W	Jumper wires, cables, busbars, aerials
Connecting objects	X	Terminal strips, connectors
(Electrically actuated mechanical devices)	Y*	(Magnetic valves, couplings, electric brakes)
(Covers, filters)	Z*	(Cable emulations, crystal filters)

\* Reserved for future standardisation











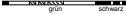

All Rittal components are subjected to comprehensive testing at our in-house laboratories.

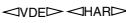

# Important marks of conformity and symbols

## Marks of conformity issued by the VDE testing agency

Marks of conformity and designation	
 <p>VDE symbol Equipment and assembly parts</p>	 <p>CEE mark of conformity (E mark) Equipment and assembly parts</p>
 <p>VDE tracer thread Cables and insulated lines</p>	 <p>CEE tracer thread Insulated lines</p>
 <p>VDE cable labelling Cables and insulated lines</p>	 <p>VDE harmonisation labelling Cables and insulated lines</p>
 <p>VDE radio suppression seal Equipment with interference suppression</p>	 <p>VDE harmonisation labelling (as tracer thread) Cables and insulated lines</p>
 <p>VDE electronic mark of conformity Electronic components</p>	 <p>CECC mark of conformity Electronic components (under preparation)</p>
 <p>VDE GS symbol Technical equipment within the scope of the VDE testing agency</p>	 <p>Electrical appliances that comply with the standards of electromagnetic compatibility based on VDE/EN/IEC/CISPR standards and other technical regulations</p>

# Index

---

<b>A</b>	
Approvals .....	97
Attenuation in dB.....	87
AWG (American Wire Gauge) numbers .....	38
<b>B</b>	
Basic units.....	9
Busbars.....	41
<b>C</b>	
Cable ducts.....	30
Cable glands .....	28
CE symbol.....	84
Colour coding of conductors .....	34
Conductor labels .....	35
Conduits.....	29
Copper busbars .....	40
Coupling.....	84
Current carrying capacity of cables.....	37
Current correction.....	43
<b>D</b>	
D0 system .....	48
Decimal parts and multiples of units.....	10
Derived units .....	9
Design verifications.....	81
DIN EN 61 439 .....	78, 80
D system .....	48
<b>E</b>	
Earthquake protection .....	98
Eddy currents .....	58
Effective enclosure surface area.....	61
EIA-310-D .....	25
Electrical power .....	16
Electrical power of motors .....	15
Electromagnetic interference.....	84
EMC .....	84
EMC diagram .....	87
Enclosure climate control.....	54, 59
Explosion protection .....	90
External diameters of lines and cables .....	36
<b>F</b>	
Field influence.....	85
Flammable gases and vapours .....	94
Full-wave rectification.....	14
Functional categories.....	50
<b>G</b>	
Graphical symbols for electrical installation ...	106
<b>H</b>	
Half-wave rectification.....	14
Heat loss .....	51
<b>I</b>	
Insulated heavy current cables.....	31
Interference factor, interference source, potentially susceptible equipment .....	84
Interference radiation .....	85
International system of units (SI).....	10
<b>L</b>	
Labelling of terminals .....	104
Line resistance .....	12
Low-voltage fuses .....	47

<b>M</b>		
Marks of conformity.....	121	
Metric system.....	22	
<b>N</b>		
NH system .....	48	
<b>O</b>		
Ohm's law .....	12	
On/off operations.....	15	
Operating categories .....	50	
Overview of standards 482.6 mm (19")/metric	22	
<b>P</b>		
Parallel connection.....	12	
PE conductor .....	74	
PE conductor connection .....	72	
PE conductor connection points.....	75	
PE conductor system .....	74	
Pitch pattern of holes.....	23	
Plastic-insulated cables .....	32	
Power in AC circuit .....	17	
Protection against contact and foreign bodies	63	
Protection categories IK code.....	65	
Protection categories IP code.....	62	
Protection category .....	77	
Protection objects.....	50	
Push-buttons.....	76	
<b>R</b>		
Rated motor currents.....	53	
Rectifier, 3-phase .....	14	
Resistance in an AC circuit .....	13	
Resistors .....	103	
Resonance in an AC circuit.....	16	
RF-shielded enclosures .....	84	
Rubber-insulated cables .....	34	
<b>S</b>		
Series connection.....	12	
Short-circuit currents .....	66	
Sinusoidal quantities .....	14	
Square-wave voltage characteristic .....	14	
<b>T</b>		
Total break time of short-circuit protection		
devices.....	49	
Transportation by crane .....	67	
Types of ignition protection .....	91	
<b>U</b>		
UL 94 .....	32	
UL 508, UL 508A .....	95	
<b>V</b>		
Voltage drop.....	13	
<b>W</b>		
Water protection.....	64	
<b>Z</b>		
Zone classification .....	90	

# Bibliography

---

IEC, VDE, DIN:

The standards mentioned

ZVEH

Zentralverband der Deutschen Elektro-  
und Informationstechnischen Handwerke:

Guidelines

Project planning and construction of switchgear  
to DIN EN 61 439 (VDE 0660-600)

Rittal GmbH & Co. KG:

“Für Schaltschrank-Experten,  
Daten, Fakten und Informationen”  
11/2018

# My Rittal online shop

## Your benefits.

- Fast, efficient ordering
- Retrieve availabilites easily and directly
- View purchase prices
- Query current order status
- Obtain a quotation automatically
- Data management
- Request conversion to PDF invoice

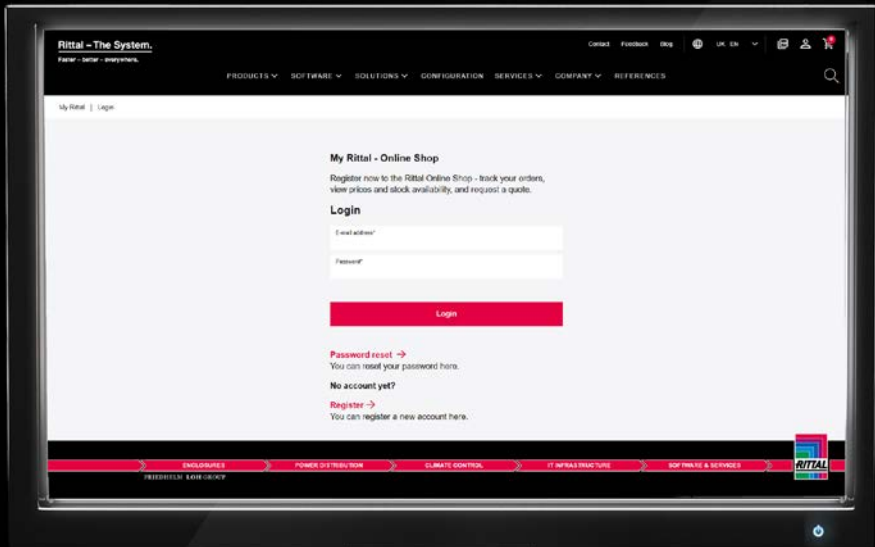

My data. My processes.  
My prices. My portal.

[www.rittal.com/contact](http://www.rittal.com/contact)

# Software solutions from Rittal and Eplan

---

Looking for an integrated software system for panel building and switchgear manufacturing?

Looking for the industry standard? Welcome to Rittal and Eplan! We provide everything that makes planning successful!

More detailed information can be found at:  
[www.rittal.com/software](http://www.rittal.com/software)

We streamline and speed up your processes at every phase: from engineering, to procurement and manufacturing, through to operation.

## Configuration

For simple selection of enclosure and rack solutions



### RiPanel

RiPanel enables fast, simple, error free selection and configuration of our products and matching accessories. Plan your required cut-outs and drilled holes, then generate the manufacturing documents and data for your configuration.

## Product data

For simple, fast design planning

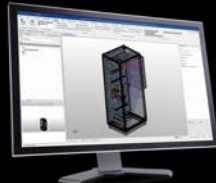

### CAD data

We can help boost the efficiency of your plant design with original CAD data for Rittal components, whichever CAD system you are using.



### EPLAN Data Portal

For direct online access to high-quality product catalogues from a host of component manufacturers. Simply drag & drop into your design.

## Rittal engineering software

For quick configuration of low-voltage switchgear and simple calculation of enclosure climate control



### **VX25 Rittal Power Engineering**

Quick and easy switchgear planning



### **RIThERM**

RIThERM takes care of the time-consuming calculation of the required cooling output and selects suitable products.

## Rittal ePOCKET – the digital wiring plan pocket

Your digital equipment and system documentation – always available, always up-to-date



More detailed information can be found at:  
[www.rittal.com/epocket](http://www.rittal.com/epocket)

### **Your design and documentation benefits with Rittal ePOCKET**

- Fast and reliable delivery of equipment and system documentation for all staff involved in the project
- Immediate availability of equipment and system documentation with an all-digital workflow: From wiring plan creation with EPLAN P8, to generation of the digital twin with EPLAN Pro Panel, to the Rittal ePOCKET
- Fast change management with the integrated EPLAN eVIEW workflow
- Save on printing costs when preparing documents
- Reduce your carbon footprint
- Up-to-date data is always available in the wiring plan pocket for all staff involved in the project
- Changes cannot be lost, thanks to clear tracking of changes and automatic notifications

# Software solutions from Rittal and Eplan

---

## Eplan engineering software

For quick configuration of low-voltage switchgear and simple calculation of enclosure climate control



**EPLAN Electric P8**  
The ECAD standard  
for engineering



**EPLAN Pro Panel**  
Product catalogues from  
a wide selection of component  
manufacturers



**EPLAN Platform**  
Software solutions for every  
engineering discipline

## Eplan production software

For efficient production and smart wiring



**EPLAN Smart Wiring**  
Clever, software-based wiring  
support

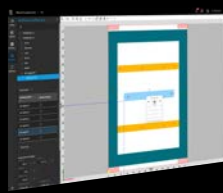

**RiPanel Processing Center**  
Production management tool  
for efficient management of  
production and machine orders

More detailed information  
can be found at:  
[www.eplan.com](http://www.eplan.com)



# Rittal – The System.

Faster – better – everywhere.

- Enclosures
- Power Distribution
- Climate Control
- IT Infrastructure
- Software & Services

You can find the contact details of all Rittal companies throughout the world here.



[www.rittal.com/contact](http://www.rittal.com/contact)

XWWW00118EN2308

