

### Pultoverdeler

Bredde 600/800 mm  
TP 6720.500, TP 6721.500

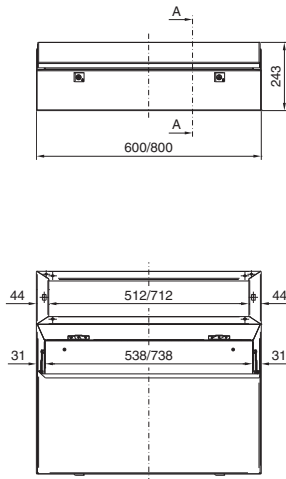

Bredde 1200/1600 mm  
TP 6723.500, TP 6723.500

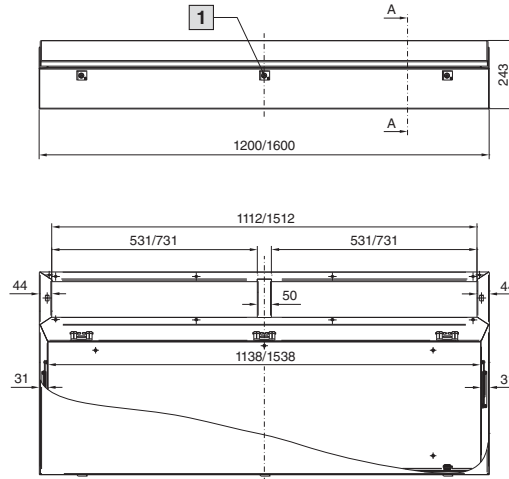

Snitt A – A

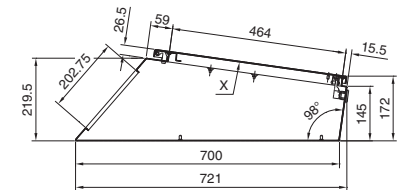

1 Kun ved 1600 mm bredde

**Henvisning:**  
– Sett fra X, se side 2

### Pultmellomdel, forberedt for pultoverdel

Bredde 600/800 mm  
TP 6714.500, TP 6715.500

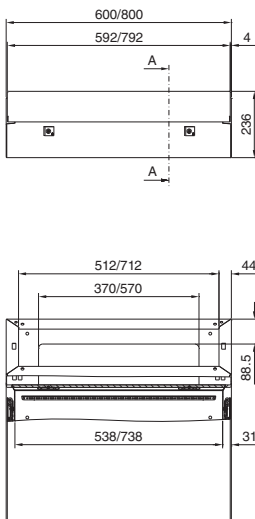

Bredde 1200/1600 mm  
TP 6716.500, TP 6717.500

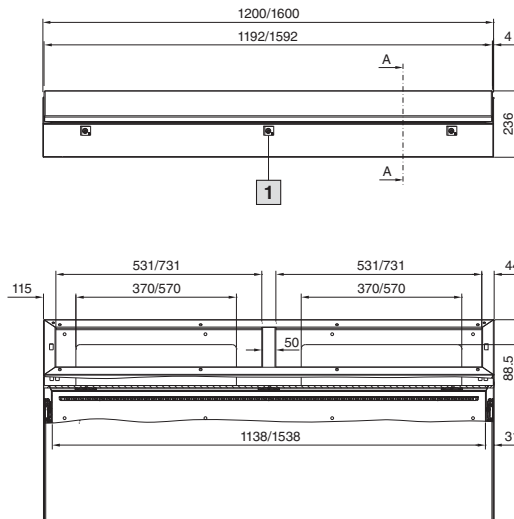

Snitt A – A

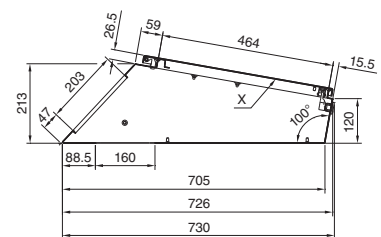

1 Kun ved 1600 mm bredde

**Henvisning:**  
– Sett fra X, se side 2

# Apparatskap

## TopPult-system TP

### Pultmellomdel, hengslet med deksel bak

Bredde 600/800 mm  
TP 6710.500, TP 6711.500

Bredde 1200/1600 mm  
TP 6712.500, TP 6713.500

Snitt A – A

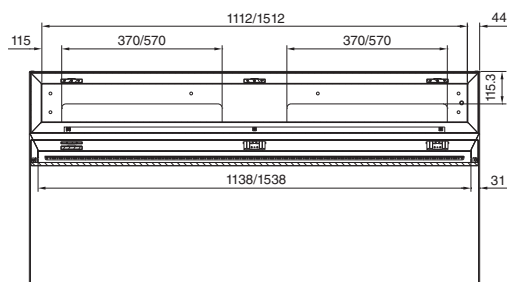
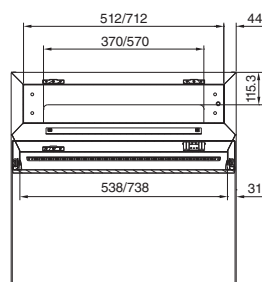
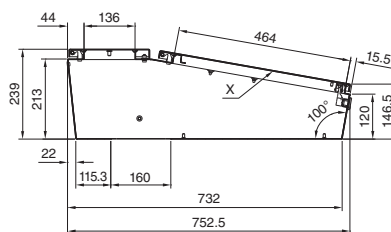
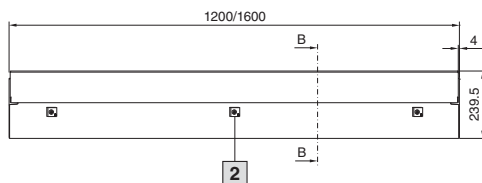
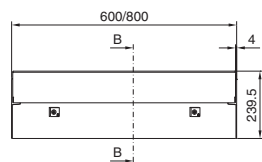

Sett fra X

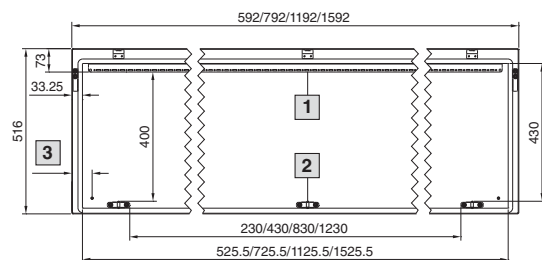

- 1 Bortfaller ved bredde 600/800 mm
- 2 Kun ved 1600 mm bredde
- 3 Bredde = 600/800/1200 = 63,5 mm  
Bredde = 1600/163,5 mm

### Pultunderdeler, dybde 400 mm

Bredde 600/800 mm  
TP 6700.500, TP 6701.500

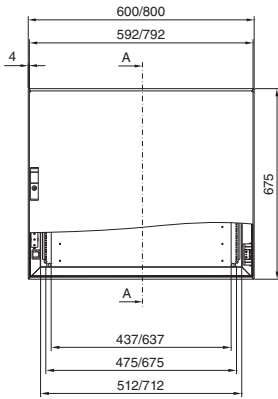

Bredde 1200/1600 mm  
TP 6702.500, TP 6703.500

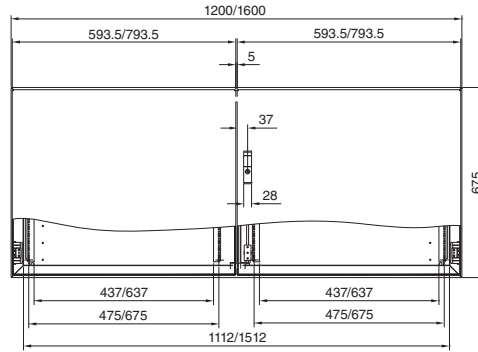

Snitt A – A

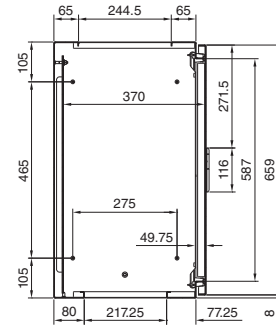

Montasjutsparing

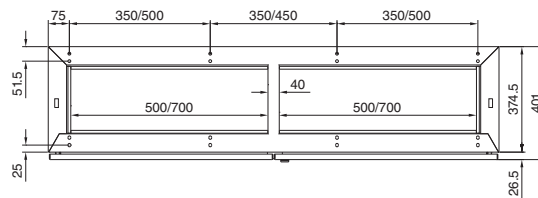
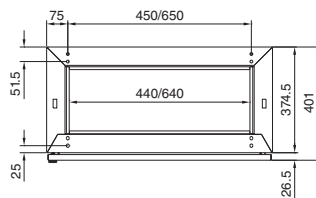
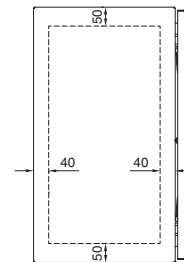

Montasjeplate

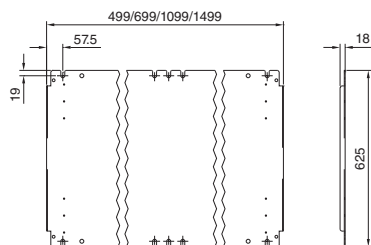

# Apparatskap

## TopPult-system TP

### Pultunderdeler, dybde 500 mm

Bredde 600/800 mm  
TP 6704.500, TP 6705.500

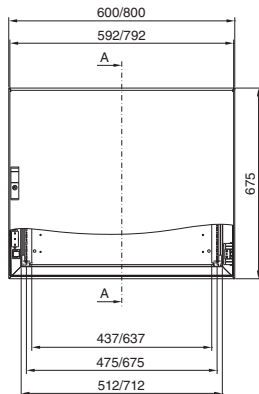

Bredde 1200/1600 mm  
TP 6706.500, TP 6707.500

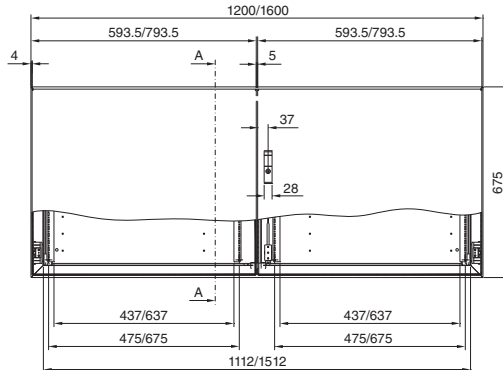

Snitt A – A

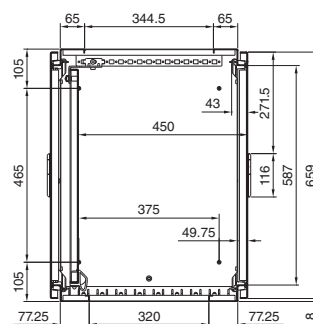

Montasjeutsparring

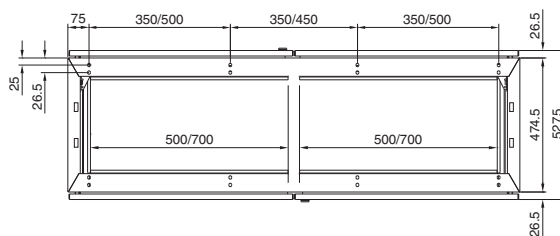
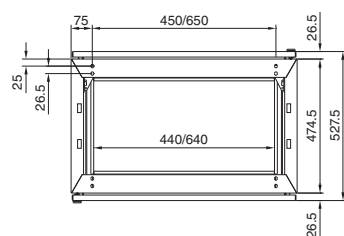
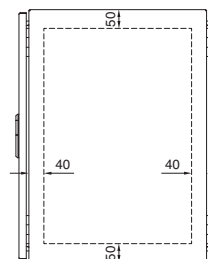

Montasjeplate

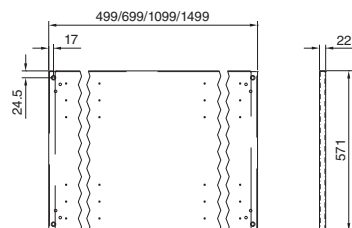

### Kombinasjonsmuligheter

Oppbygging 3-delt

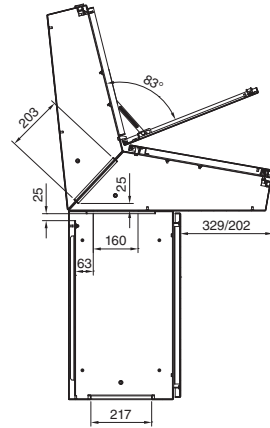
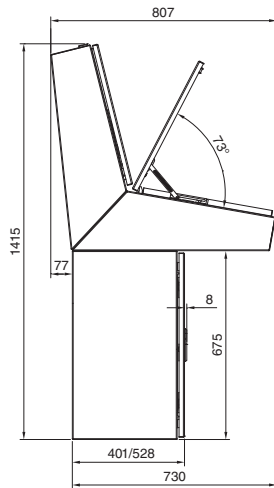

Oppbygging 2-delt

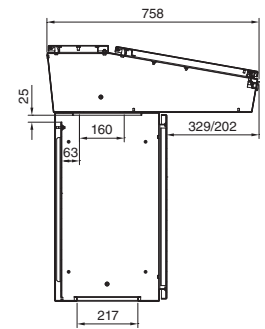
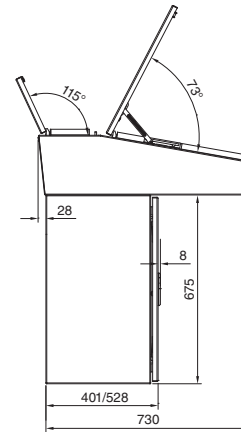

Oppbygging 1-delt

