

Rittal – The System.

Faster – better – everywhere.

► Technical System Catalog RiLine and Maxi-PLS



ENCLOSURES

POWER DISTRIBUTION

CLIMATE CONTROL

IT INFRASTRUCTURE

SOFTWARE & SERVICES



FRIEDHELM LOH GROUP



Busbar systems

Rittal offers a comprehensive system package with components for individual customer solutions. Wherever in the world they are used, Rittal busbar systems are suitable for a wide range of applications, thanks to comprehensive testing, design verifications and high-profile approvals. Simple project planning, fast assembly and optimum protection against indirect live contact are included as a matter of course with all Rittal busbar system solutions. To this end, Rittal offers support systems and bars in conjunction with connection technology, component adaptors and fuse components – flexible units that meet your requirements to perfection.

- **Design certificates:** Software-supported design certificates in accordance with IEC 61 439-1
- **Output:** Optimum rating data for AC and DC applications
- **Save time:** Cost-effective, thanks to simple assembly
- **Energy efficiency:** Low-loss operation, thanks to perfect contact and connection technology
- **Safety:** Optimum protection against indirect live contact at all times
- **For IEC and UL markets:** RiLine components meet the relevant standards and licensing conditions

Busbar systems

RiLine busbar systems

In the field of low-voltage technology, RiLine plays a key role in mechanical, plant and control engineering for industrial systems and data centres, as well as in Ri4Power system technology.

- Flat bar system up to 800 A.
- PLS busbar system 800 A/1600 A.
- 60 mm bar centre distance, 3- and 4-pole.
- System technology tested to IEC 61 439-1 and UL 508 approved.
- High safety standards for global use.
- Unlike busbar sections with a rectangular cross-section, PLS busbars offer unrestricted top-mounting of the busbar supports with top-mounting components.
- Reliable contact hazard protection thanks to all-round encapsulation of the busbar system (base tray, cover section and end cover).

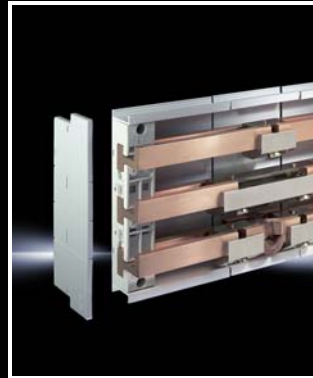

RiLine busbar systems



Benefits at a glance:

- Individual and cost-saving, thanks to component modularity and flexibility
- Complete solutions up to 1600 A for AC and DC applications
- Optimum protection against indirect live contact with all-round encapsulation of the busbar systems
- Maximum safety thanks to comprehensive IEC testing and UL approvals
- Optimum space utilisation with the busbar support suitable for top mounting
- Cost-effective, thanks to simple assembly
- Power Engineering software for fast, simple configuration

When it comes to future-oriented solutions for modern low-voltage power distribution, you are most definitely on the right track with Rittal busbar systems. RiLine, the flexible 60 mm system – assembly-friendly, time-saving, individual and modular. The beneficial features of the RiLine busbar technology are a versatile range of applications, individual modularity, and tested for safe operation.

In RiLine, Rittal has “cULus-listed” approval of a 60 mm busbar system. This approval provides decisive advantages for international machinery and plant manufacturers with target markets in the USA or Canada: minimal design input, simplified sign-off of plant by UL (Underwriters Laboratories) and CSA (Canadian Standards Association) and therefore most importantly: testing for compliance with the Conditions of Acceptability (CoA) of all UL-Recognized Components used becomes superfluous.

RiLine busbar systems

Flat copper bar system

- Rated current up to 800 A
- 60 mm bar centre distance
- 3- and 4-pole version

Approvals

- IEC 61 439-1
- GL
- UL
- CSA

Integral adaptation of the busbar cross-section

Busbar support with integral cross-section adaptation for busbars 12 x 5 to 30 x 10 mm. An integral locating block automatically adapts to busbar widths of 15, 20, 25 or 30 mm. Spacers are available for width 12 mm. The 5 and 10 mm busbar thickness is set using a slide.



PLS busbar system

- Rated current up to 800 A/1600 A
- 60 mm bar centre distance
- Design:
 - 3-pole (PLS 800/PLS 1600)
 - 4-pole (PLS 1600)

Approvals

- IEC 61 439-1
- GL
- UL
- CSA

Top-mounting

The special design of the busbars and the structure of the busbar support allow unrestricted top-mounting of the busbar support with top-mounting components such as busbar connection adaptors, fuse elements and component adaptors. In other words, free positioning of the support means easier planning, greater stability where required, and optimum space utilisation. The design also allows optimum heat dissipation into the environment. This means that the current density is higher than in the flat bar.



Contact hazard protection

Optimum contact hazard protection thanks to all-round encapsulation of the busbar system with base tray, cover section and end cover.

RiLine connection system



Benefits at a glance:

- The right solution for every application
- User-friendly connection system for cable conductors and laminated copper bars
- Short circuit protection, shielded routing of the contact tracks
- Variants with feed-through function

The combination of box and prism terminal technology allows users to specify the connection type shortly prior to commissioning. Either flexible busbars or cable conductors may be used conveniently, quickly and reliably.

RiLine connection system

Connection adaptor

- Versions
 - 63 A to 1600 A (3-pole)
 - 125 A to 1600 A (4-pole)
- For direct mounting on 60 mm bar systems.
- Suitable for feeder circuits to UL 508A.
- Cable outlet optionally top or bottom. There are also adaptors with feed-through function, i.e. connection at the top and bottom. This makes it possible to connect multiple bar systems positioned one on top of the other.
- Modern enclosure design with protection category IP2X and clear slide latching of the cover.
- Combined clamping prisms for the connection of cable conductors and laminated copper bars.
- With optional arrangement of the clamping prisms, the same clamp can be used to connect either cable conductors or laminated copper bars.



Connection block

- Suitable for conductor connection to PE, N and DC busbar systems with cable or laminated copper bar.
- Cable outlet optionally at top or bottom. The feed-through function of the connection block also makes it possible to connect several systems positioned one on top of the other.
- Optionally may be used on flat copper bars up to 30 x 10 mm or PLS busbars.



Connection clamps

- For universal applications, conductor connection clamps are available for connecting cable conductors and laminated copper bars.



RiLine component adaptors



Benefits at a glance:

- To suit all commercially available circuit-breakers
- Mounting benefits thanks to
 - Universal sliding block mounting system and
 - User-friendly support frame system
- Variable platform technology for switchgear assembly:
 - Adaptor version with and without support frames
- Cost-effective modular configuration of motor starter combinations
- Minimal downtime when replacing top-mounted equipment
- Simple module formation with free baying options

Innovative modularity, a high level of contact stability and fresh, rational approaches to component assembly are the distinguishing features of all RiLine component adaptors.

The objectives are always the same: maximum operational and maintenance reliability, coupled with low installation and servicing costs.

RiLine component adaptors

1 OM adaptor

- Assembly-friendly snap-on mounting on 60 mm busbar systems (3-pole).
- To suit all commercially available circuit-breakers.
- With pre-configured connection cables for equipment connection.
- For side auxiliary switches and expansion modules, a 10 mm insert strip is available which may be bayed on both sides as often as required. A channel integrated into the insert strips aids secure routing of cables.
- Safe support of starter combinations with special PinBlock.
- Short circuit-resistant, fully shielded routing of the contact tracks.



User-friendly support frame system and baying connection

- System separation between the adaptor section and support frame facilitates user-friendly assembly of the top-mounted equipment outside of the switchgear assembly. In this way, the busbars remain covered at all times, because only the support frame is removed during servicing.
- OM adaptors and OM supports (without contact system) may be freely bayed in the basic widths 45 mm and 55 mm. Bayed using a connection pin from the front. This allows retrospective creation of a module.

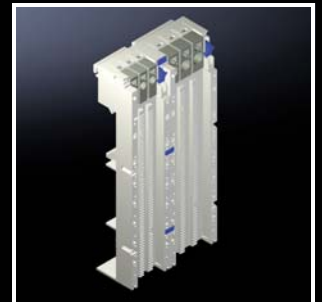
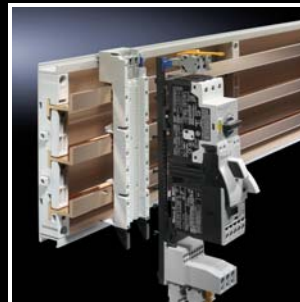

2 Circuit-breaker component adaptor

- For mounting on 60 mm busbar systems (3- and 4-pole).
- Fits all standard commercial circuit-breakers (MCCB = Moulded Case Circuit Breaker).
- Cable outlet top or bottom.
- Short circuit-resistant, fully shielded routing of the contact tracks.
- Positioning of the connection clamps for compact component connection, e.g. with special laminated strip connection bracket or connection with round conductors or with pre-configured connection strips.



Universal sliding block attachment system

- Simple preassembly of the sliding blocks on the circuit-breaker.
- The circuit-breaker is assembled by inserting the sliding blocks into the guide channels on the circuit-breaker component adaptor.
- Secure positioning of the switchgear thanks to the end stop.



RiLine fuse elements



Benefits at a glance:

- Reliable function at high currents
- Tested and/or approved to valid regulations/standards
- Simple handling during assembly
- Direct contacting on busbars, no drilling required
- Convenient, assembly-friendly direct connection
- High switching capacity
- Suitable for AC and DC applications

Rittal provides innovative fuse components for IEC or UL applications up to 630 A: NH disconnectors with UR approval for semi-conductor fuses and fuse holders in the RiLine Class range for J-Class fuse inserts, approved to the latest UL /CSA standards.

A wide range of fuse options that may be used for both the AC and DC sector.

We have the right solution to suit every application.

RiLine fuse elements

NH fuse-switch disconnectors

- Size 000 to 3.
- 3-pole, switchable.
- For mounting plate assembly or for mounting on 60 mm busbar systems.
- Versions available in sizes 00 to 3, with or without fuse monitoring.
- For AC and DC applications.
- In addition to the existing type testing of NH disconnectors to DIN EN 60 947-3, sizes 00 to 3 (without fuse monitoring) have also undergone UL testing for the use of NH fuses with UR approval.
- Approved to the very latest UL/CSA standard (UL 4248-1/UL 4248-8, CSA C22.2 No. 4248.107/ CSA C22.2 No. 4248-07).

Further information may be found on pages 12.



RiLine fuse elements



NH fuse-switch disconnectors

Easy changeover of the cable outlet

The uniform design of the RiLine generation of NH disconnectors combines optimum functionality with an attractive design. This feature supports system-compatible integration into the RiLine contact hazard protection concept with base tray. In just 3 seconds, the same device may be used to swap the cable outlet from top to bottom for all RiLine NH bus-mounting fuse-switch disconnectors by simply rotating the mounting hook.

In this way, there is no need to decide whether the cable outlet will go at the top or bottom until immediately prior to assembly. This function offers a clear benefit for customers, by halving the required warehousing and associated costs.

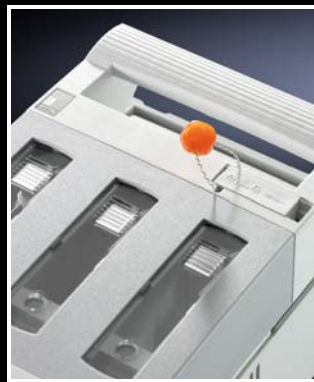

Lid lock and seal

All designs are supplied as standard with a lock that prevents unintentional opening of the disconnecter lid. In addition, the lock position may also be sealed with sealing wire.



Simple signalling of the switching position with micro-switches

All sizes have the option of accommodating micro-switches to indicate the switching position. The micro-switch simply clips into the relevant position in the disconnecter chassis. Two micro-switch locators are available as standard for each device. This allows the switching position of the disconnecter lid to be communicated to a programmable logic controller (PLC), while using a second micro-switch to operate the load contactor at the same time. The micro-switch wiring is routed through the device to the rear or through the pre-punched knock-out of the contact hazard protection cover plates.

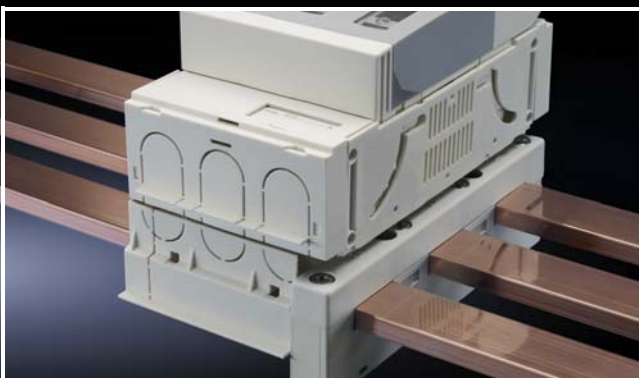

Top-mounting of supports even with flat bars

The panels (removable at the side) allow top-mounting of RiLine busbar supports for all flat bars, enabling very compact configuration of the units. In conjunction with the super-slimline design, this allows a space-saving configuration.

RiLine fuse elements

RiLine Class fuse holder

UL fuse technology

UL approved fuse technology for use in the North American market.

Fuse holder for cylindrical fuse inserts

- J-Class
- CC-Class



Fuse holder 30 A/60 A

- For the use of fuses to American/Canadian standards.
- For snap-on mounting on support rails 35 mm (7.5/10 mm high) to DIN EN 60 715 or RiLine component adaptor combinations (OM adaptors/supports).
- Visual fuse monitoring via indicator lights
- 3-pole, switchable off-load.
- For cylindrical CC-Class fuses to UL 4248-8 or J-Class fuses in 2 current ranges: 30 A/60 A.
- Approved to the very latest UL/CSA standard (UL 512, CSA C22.2 No. 39).



Fuse holder 61 A to 400 A

- For the use of fuses to American/Canadian standards.
- Versions for direct mounting on 60 mm busbar systems.
- 3-pole, for use as fuse carriers.
- For cylindrical J-Class fuses to UL 4248-8 in 3 current ranges: 61-101 A/101-200 A/201-400 A.
- Reliable protection against indirect live contact with lid and internal contact hazard protection covers.
- Self-locking voltage test holes and lid lock/seal.
- Approved to the very latest UL/CSA standard (UL 4248-1/UL 4248-8, CSA C22.2 No. 4248.107/ CSA C22.2 No. 4248-07).



Information on UL (Underwriters Laboratories)

Information on UL

UL or Underwriters Laboratories was founded in 1894 as a non-profit-making organisation for testing and certification. UL operates several testing laboratories in the United States

and subsidiaries worldwide, with an emphasis on product testing aimed at general safety.

Why are UL approvals important?

- International regulations and standards such as NEMA and IEC are used by manufacturers as a basis for product developments and subsequent testing.
- Nationally recognised test laboratories confirm and certify that a product complies with the specific standards; in North America this is carried out by organisations such as UL or CSA (Canadian Standards Association).
- For many applications, the sole use of UL and/or CSA-approved products is a requirement; consequently, it is advisable to design electrical controllers for North American applications with suitable UL-approved components.

How does the US system for electrical safety work?

Every piece of electrical equipment (machine/plant) is tested by the competent local inspector (AHJ = Authority Having Jurisdiction) prior to commissioning. The AHJ has the final say with regard to commissioning. All AHJs use Standard NFPA 70 (NFPA = National Fire Protection Association) as a basis, which is generally regarded as the NEC (National Electrical Code). NFPA 70 is therefore an important basis for UL 508A (Industrial

Control Panels). The AHJ considers the use of UL-recognized or UL-listed components an important indication that a system complies with the safety requirements to NFPA 70. This saves time and money during construction and commissioning of the equipment, as the UL symbol indicates that testing of the components and/or of the system did not reveal any foreseeable risks with regard to fire, electric shock and associated dangers.

The UL symbols: “UL listed” or “UL recognized”

When labelling UL-approved products, a general distinction is made between Recognized Components and Listed Devices:

1 (Recognized Components)

This label is used on products which are not complete in terms of their application. These products are listed in the UL's “yellow component database”. When used correctly, these components must comply with the “Conditions of Acceptability”, which list the framework conditions and application parameters approved by the UL.



2 (Listed Devices)

Here, it is only important to note that the remarks and rating data specified on the product are observed with the application. Terminals for field-wiring are authorised as Listed Devices (see “Important remarks”, point 3, page 15).



Recognized Component 
Sample rating plate for a busbar support with .



Listed Device 
Sample rating plate for a busbar support with .

Information on UL (Underwriters Laboratories)

Application areas for UL 508 and UL 508A

UL 508 describes industrial control components and is therefore the decisive standard for the assessment of Rittal power distribution components. For example, this standard contains information on:

- Starters
- Relays and contactors
- Circuit-breakers
- Controllers

UL 508A describes industrial control panels and is therefore the decisive standard for switchgear manufacturers.

For example, this standard contains information on:

- Machine controllers
- Elevator controllers
- Crane controllers
- Equipment for heating, air-conditioning and ventilation systems and describes, for example, in table SA 1.1, the devices which may be used in this standard and the requirements governing the standard and category number.

Both standards describe control systems for general industrial applications with a rated voltage of up to 600 V. The maximum permissible ambient temperature is 40°C.

Distinguishing between feeder and branch circuits

Standard UL 508A makes a distinction between feeder circuits and branch & control circuits. Generally speaking, the term "feeder circuits" refers to the part of the circuit located at the supply end before the last overcurrent protective device (a device approved to UL 489). Increased requirements with regard to creepage distances and clearances apply to this part of the circuit.

The term "branch & control circuits" refers to the part of the circuit located after the last overcurrent protective device. When using busbar systems, it is important to know whether the application is in the feeder section or the branch section, as the requirements governing the required creepage distances and clearances are significantly higher for feeder circuits.

Important notes for the use of busbar systems to UL 508A

1. Creepage distances and clearances

One of the principal requirements in UL 508A is the amendment to the required creepage distances and clearances for feeder circuits. The following distances are required for applications >250 V:

- Between phases:
 - A** Creepage distance 50.8 mm (2 inches)
 - B** Clearance 25.4 mm (1 inch)
- Between phase and earthed, uninsulated metal parts:
 - A** Creepage distance 25.4 mm (1 inch)
 - B** Clearance 25.4 mm (1 inch)

Rittal RiLine complies with these requirements. All busbar connection adaptors and component adaptors (OM adaptors with standard AWG connection cables and circuit-breaker adaptors) have been designed in accordance with these requirements. However, users should bear in mind a small number of differences from the IEC version:

- Special UL busbar supports for flat bars and Rittal PLS with increased creepage distances and clearances.
- In order to guarantee the required distances between live parts and the earthed mounting plate, the use of a RiLine base tray is compulsory.

2. Rated currents

For untested busbar applications, UL 508A specifies a current carrying capacity of 1000 A/inch² (1.5 A/mm²). This value may be higher if the product or application has undergone suitable testing. Rittal has conducted extensive testing in this respect in order to give users the maximum benefits when using the RiLine busbar system. The benefit of such testing is that busbar systems with higher rated currents may be used than permitted by the default value. For example, a busbar with dimensions 30 x 10 mm can take 700 A instead of 465 A.

3. Terminals for factory or field wiring

In accordance with the UL standards, connection terminals may be approved for factory or field wiring. If a terminal is approved for factory wiring, it may only be used in switchgear assembly by suitably trained professionals. If connection terminals are to be used in the field (e.g. on a construction site), the component must be approved for field wiring.

The terminals of the busbar connection adaptors and component adaptors in the RiLine series have therefore been tested for field wiring applications.

Definition of creepage distances and clearances:

- A** Creepage distance between active conductors/busbars
- B** Clearance between active conductors/busbars
- C** Creepage distance between active conductors/busbars and earthed metal parts
- D** Clearance between active conductors/busbars and earthed metal parts

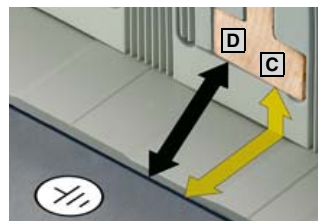
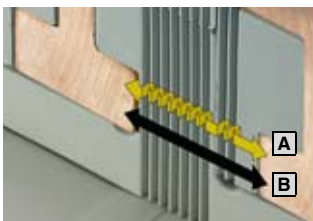

Information on UL (Underwriters Laboratories)

Simple, fast system sign-offs

Save time and money with easier UL and CSA sign-offs.

The approval of power distribution components is becoming ever more important for international switchgear manufacturers. The  approval of RiLine busbar systems offers significant advantages for both the UL and CSA market. Complex, time-consuming engineering, inspection and sign-off processes are reduced to a minimum.

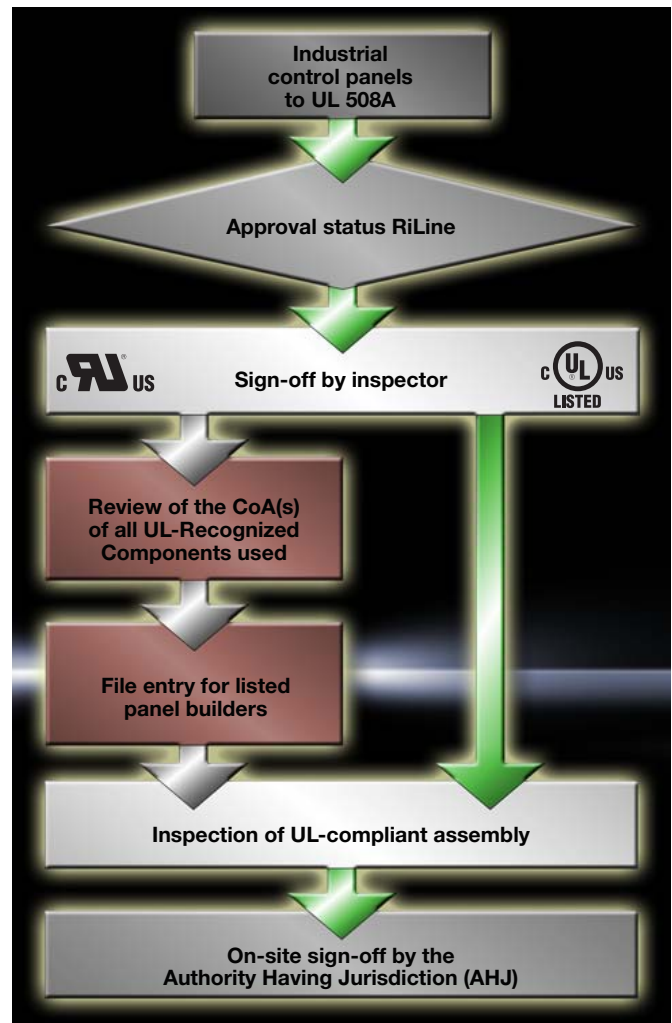

Important benefits and added value with RiLine

1. Dramatic time savings

Straightforward UL and CSA sign-off processes.

2. Conditions of Acceptability (CoA) are eliminated, documentation work is minimised

No additional tests required as with UL-Recognized Components.

3. Cost savings for listed switchgear manufacturers

The usual UL costs for file entry of the UL-Recognized Components are eliminated.

4. A high level of acceptance among end customers

RiLine  meets the requirements of valid safety standards to perfection.

5. Barrier-free access to the CSA market

 products are accepted on the Canadian market with no further test requirements.

6. Time- and cost-efficient project planning

Reduced project planning work when incorporating the engineering considerations.

Busbar system Maxi-PLS



Benefits at a glance:

- High productivity thanks to simple project planning and fast assembly of the system technology.
- Cable and busbar connections are achieved with the tried-and-trusted sliding block technique, no drilling required.
- Compact busbar design.
- Standardised connection components throughout.
- High standard of safety.

The innovative Maxi-PLS busbar system allows customer-oriented configuration of low-voltage distributors and low-voltage switchgear in building technology, industry and regenerative energy recovery. The standardised Maxi-PLS busbar systems feature an exceptionally compact design and ingeniously simple assembly technology. The Maxi-PLS system with stepped arrangement is particularly ideal for the connection of external cables.

All system components are standardised, inexpensively mass-produced and supplied ready for configuration. This makes Maxi-PLS the ideal link between the power supply and power distribution to the smallest piece of equipment.

Busbar system Maxi-PLS



Beneficial system technology

- Beneficial system technology and coordinated dimensional pitch patterns for precise-fit, fast installation of Maxi-PLS holders and bars.
- Compact design with square profile cross-section (45 x 45 mm to 2500 A, 60 x 60 mm to 4000 A).
- The section lengths are sized to match the enclosure widths.
- Individual contact hazard protection with simple clip-on mounting of covers.



Four attachment levels

- The four attachment levels of Maxi-PLS busbars facilitate attachment and contacting on all sides with no drilling required.
- Contact makers facilitate the direct connection of intersecting bars.



Simple, practical connection

- Linear contacting of round conductors, laminated flat copper, connection brackets and connection kits.
- Terminal studs and connection plates for ring terminals, as well as all variants of round conductors and flat bars.
- Stepped arrangement ensures simple, clear assembly of cables and lines.

Rittal – The System.

Faster – better – everywhere.

- Enclosures
- Power Distribution
- Climate Control
- IT Infrastructure
- Software & Services

